



BUY – SELL – REPAIR – CALIBRATE  
[sales@simbol.ca](mailto:sales@simbol.ca) 1-866-396-6248



Simbol Test Systems is the one-stop shop for all your fiber optic test equipment and measurement needs. As we are exclusively focused on e-commerce and international distribution of photonic products since 2000, our customers rely on the [AssetRelay](#) catalog to find our stock listings of thousands of used and refurbished popular test equipment. They know they can get repair, customization and calibration services from our laboratory for their own fiber optic instruments from all renowned brand manufacturers.

If you wish to buy or sell an AQ6370 or any model of Ando (Yokogawa) OSA, visit our catalog [here](#) to see our current stock with actual photos.

## The Simbol Test Systems expertise

With more than 20 years of expertise in repair of OSA, Tunable Lasers, Wavemeters and more, the quality of our services is renowned amongst the service centers community and highly appreciated by our partners and customers. We developed custom software allowing us to perform automatic calibration tests and write up to date results in the OSA calibration tables. Don't settle for a two-page summary assessment to trust that your OSA is operating on the full range; our report contains the complete table of all results, confirming it has **really** been tested. A report from other labs with less data points reflects a not completely calibrated unit. So be careful of other sellers saying their equipment is "tested good", "powered on, self-tested", "pulled from a working environment". When you choose AssetRelay, you can be confident that we actually test everything we sell so you know it will work when it gets to your workplace.

### **Yokogawa AQ6370 Optical Spectrum Analyzer (OSA) Repair and Calibration Services**

The AQ6370 OSA goes through a premium calibration to ensure it meets or exceeds manufacturer's published specifications. The equipment is shipped with a comprehensive 10-page calibration report including data, a calibration sticker and its own dated calibration certificate. A report from other labs with less data points reflects a not completely calibrated unit.

Simbol Test Systems is the only North America independent lab with the capability of inputting proper data points in the OSA memory. If your unit does not pass calibration, we will quote a complete repair and get your OSA back to perfect working condition.

### **List of specifications calibrated**

- Wavelength Calibration with Internal Cell
- Wavelength Accuracy cal external source
- Wavelength Resolution Accuracy
- Wavelength Linearity
- Wavelength Reproducibility
- Level Linearity
- Wide Band Level Stability
- Level Accuracy
- Level Flatness
- Polarization Dependency
- Dynamic Range
- Measurement Level Range
- Maximum input level

Traceability: Instrumentation used during this calibration is traceable to N.I.S.T (National Institute of Standards and Technology) or C.N.R.C. (Canadian National Research Council).

---

---

**User's  
Manual**

**AQ6370  
Optical Spectrum Analyzer**

---

# Product Registration

Thank you for purchasing YOKOGAWA products.

YOKOGAWA provides registered users with a variety of information and services.

Please allow us to serve you best by completing the product registration form accessible from our homepage.

<http://www.yokogawa.com/tm/>

---

## Foreword

Thank you for purchasing the AQ6370 Optical Spectrum Analyzer. This instrument enables high speed measurement of the optical properties of LD and LED light sources, optical amps, and other devices. To improve ease of use, it includes mouse-based user operation and a brand-new zoom function.

This user's manual describes the instrument's functions, operating procedures, and handling precautions, and provides other important information for use of the instrument. For correct operation, please read this manual thoroughly before use. After reading this manual, keep it in a convenient location for quick reference in the event a question arises during operation. There are two manuals for the AQ6370 including this one. Read them along with this manual.

Manual Title	Manual No.	Description
AQ6370 Optical Spectrum Analyzer User's Manual (Vol 1/2)	IM 735301-01E	This manual. Explains all functions and operating procedures of the AQ6370 except remote control and program functions.
AQ6370 Optical Spectrum Analyzer Remote Control User's Manual (Vol 2/2)	IM 735301-17E	Explains functions for controlling the instrument with communication commands and program functions.

## Notes

- The contents of this manual are subject to change without prior notice as a result of improvements in the instrument's performance and functions. Display contents illustrated in this manual may differ slightly from what actually appears on your screen.
- Every effort has been made in the preparation of this manual to ensure the accuracy of its contents. However, should you have any questions or find any errors, please contact your nearest YOKOGAWA dealer.
- Copying or reproducing all or any part of the contents of this manual without the permission of Yokogawa Electric Corporation is strictly prohibited.
- A warranty sheet is included. It cannot be reissued. After reading the sheet, keep it in a safe location.

## Trademarks

- Microsoft, Windows and Windows XP are trademarks or registered trademarks of Microsoft Corporation in the United States and/or other countries.
- Adobe, Acrobat, and PostScript are trademarks or registered trademarks of Adobe Systems incorporated.
- The company and product names used in this manual are not accompanied by the trademark or registered trademark symbols(TM,®)
- Other company and product names are trademarks or registered trademarks of their respective companies.

## Revisions

- 1st Edition: March 2006
- 2nd Edition: July 2006

# Checking the Contents of the Package

After opening the package, check the following items before beginning use. If any of the contents are incorrect, missing, or appear to be abnormal, please contact your Yokogawa dealer or representative.

## AQ6370 Main Unit

Check that the model and suffix code on the name plate on the rear of the instrument match those of your order. When contacting the dealer from which you purchased the instrument, please give them the instrument number.

MODEL	Suffix Code	Description
735301		Optical Spectrum Analyzer AQ6370
Power cord	-D	UL/CSA standard power cord (part no.: A1006WD), maximum rated voltage: 125 V
	-F	VDE standard power cord (part no.: A1009WD), maximum rated voltage: 250 V
	-G	AS standard power cord (part no.: A1013WD), maximum rated voltage: 250 V
	-Q	BS standard power cord (part no.: A1054WD), maximum rated voltage: 250 V
	-H	GB standard power cord (complies with the CCC) (part no.: A1006WD), maximum rated voltage: 250 V
	-M	UL/CSA standard power cord with 3P/2P converter (part no.: A1006WD), maximum rated voltage: 125 V
Options	/FC	AQ9447 (FC) connector adapter (for optical input)
	/SC	AQ9447 (SC) connector adapter (for optical input)
	/ST	AQ9447 (ST) connector adapter (for optical input)
	/RFC	AQ9441 (FC) universal adapter (for calibration light source output)
	/RSC	AQ9441 (SC) universal adapter (for calibration light source output)
	/RST	AQ9441 (ST) universal adapter (for calibration light source output)
	/B5	Built-in thermal printer

- **No. (Instrument Number)**  
Please contact your nearest Yokogawa representative.

## Accessories

Part Name	Quantity
Power cord (with 3 to 2 prong adapter)	1
User's manual	1
Remote control user's manual	1
Printer roll paper (with /B5 option)	1

## Accessories (Sold Separately)

Part Name	Model/Part Number	Specifications
AQ9447 connector adapter	810804602-FCC	FC type (for optical input)
	810804602-SCC	SC type (for optical input)
	810804602-STC	ST type (for optical input)
AQ9441 universal adapter	813917321-FCC	FC type (for calibration light source output)
	813917321-SCC	SC type (for calibration light source output)
	813917321-STC	ST type (for calibration light source output)
Printer roll paper	B9988AE	Lot size is 10 rolls, 10 meters each

---

# Safety Precautions

This instrument is an IEC safety class I (provided with terminal for protective earth grounding). The general safety precautions described herein must be observed during all phases of operation. If the instrument is used in a manner not specified in this manual, the protection provided by the instrument may be impaired. Yokogawa Electric Corporation assumes no liability for the customer's failure to comply with these requirements.

## The following symbols are used on this instrument.



*Danger, Refer to the user's manual.*

This symbol appears on dangerous locations on the instrument which require special instructions for proper handling or use. The same symbol appears in the corresponding place in the manual to identify those instructions.



Alternating current



ON(power)



OFF(power)

**Make sure to comply with precautions below. Not complying might result in injury or death.**



---

**WARNING**

- **Use the Correct Power Supply**  
Before connecting the power cord, ensure that the source voltage matches the rated supply voltage of the instrument and that it is within the maximum rated voltage of the provided power cord.
  - **Use the Correct Power Cord and Plug**  
To prevent the possibility of electric shock or fire, be sure to use the power cord supplied by YOKOGAWA. The main power plug must be plugged into an outlet with a protective earth terminal. Do not disable this protection by using an extension cord without protective earth grounding.
  - **Connect the Protective Grounding Terminal**  
Make sure to connect the protective earth to prevent electric shock before turning ON the power. The power cord that comes with the instrument is a three-prong type power cord. Connect the power cord to a properly grounded three-prong outlet.
  - **Do not Impair the Protective Grounding**  
Never cut off the internal or external protective earth wire or disconnect the wiring of the protective earth terminal. Doing so poses a potential shock hazard.
  - **Do not Operate with Defective Protective Grounding or Fuse**  
Do not operate the instrument if the protective earth or fuse might be defective. Make sure to check them before operation.
  - **Do not Operate in an Explosive Atmosphere**  
Do not operate the instrument in the presence of flammable liquids or vapors. Operation in such environments constitutes a safety hazard.
  - **Do not Remove Covers**  
The covers should be removed by YOKOGAWA's qualified personnel only. Opening the cover is dangerous, because some areas inside the instrument have high voltages.
-

---

# Conventions Used in This Manual

## Safety Markings

The following markings are used in this manual.



Improper handling or use can lead to injury to the user or damage to the instrument. This symbol appears on the instrument to indicate that the user must refer to the user's manual for special instructions. The same symbol appears in the corresponding place in the user's manual to identify those instructions. In the manual, the symbol is used in conjunction with the word "WARNING" or "CAUTION."

### **WARNING**

Calls attention to actions or conditions that could cause serious or fatal injury to the user, and precautions that can be taken to prevent such occurrences.

---

### **CAUTION**

Calls attentions to actions or conditions that could cause light injury to the user or damage to the instrument or user's data, and precautions that can be taken to prevent such occurrences.

### **Note**

Calls attention to information that is important for proper operation of the instrument.

## Notations Used on Pages Describing Operating Procedures

On pages that describe the operating procedures in Chapter 3 through 11, the following notations are used to distinguish the procedures from their explanations.

### **Procedure**

This subsection contains the operating procedure used to carry out the function described in the current chapter. All procedures are written with inexperienced users in mind; experienced users may not need to carry out all the steps.

### **Explanation**

This subsection describes the setup parameters and the limitations on the procedures. It may not give a detailed explanation of the function. For a detailed explanation of the function, see chapter 2.

## Notations Used in the Procedures

---

### **Panel Keys and Soft keys**

Bold characters used in the procedural explanations indicate characters that are marked on the panel keys or the characters of the soft keys displayed on the screen menu.

---

## Unit

---

k: Denotes "1000."	Example: 100kS/s
K: Denotes "1024."	Example: 459KB (file data size)

---

# Flow of Operation

The figure below is provided to familiarize the first-time user with the general flow of this instrument operation. For a description of each item, see the relevant section or chapter.

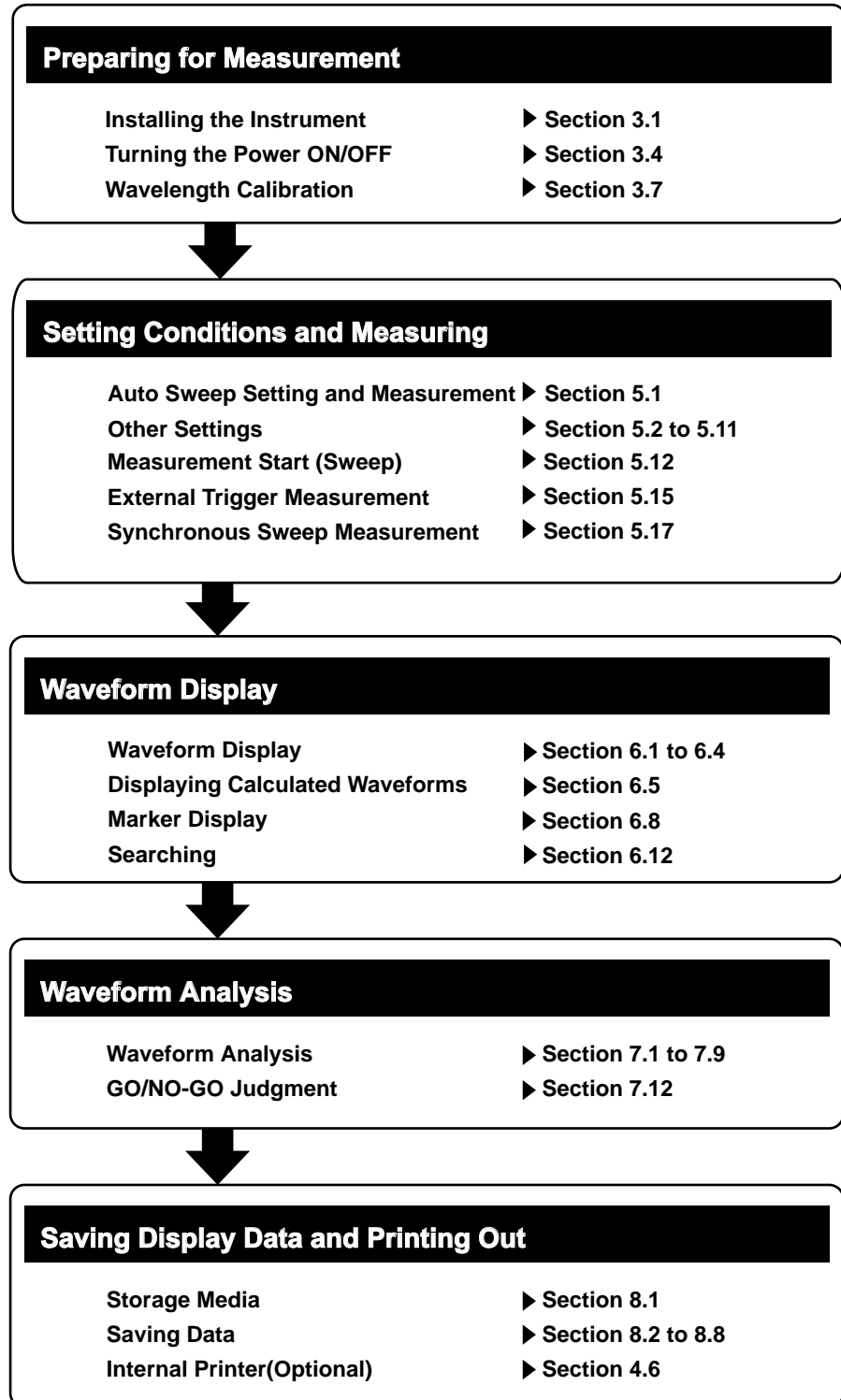

---

# Contents

Checking the Contents of the Package .....	ii
Safety Precautions .....	iii
Conventions Used in This Manual.....	v
Flow of Operation .....	vi

## Chapter 1 Part Names and Functions

1.1 Front Panel.....	1-1
1.2 Rear Panel .....	1-2
1.3 Panel Keys and Knobs .....	1-3
1.4 LCD Screen.....	1-6

## Chapter 2 Functions

2.1 System Structure.....	2-1
2.2 Measurement .....	2-2
2.3 Waveform Display .....	2-7
2.4 Analysis .....	2-11
2.5 Other .....	2-13

## Chapter 3 Preparing for Measurement

3.1 Installing the Instrument .....	3-1
3.2 Attaching the Connector Adapter .....	3-3
3.3 Connecting a Communication Interface .....	3-5
⚠ 3.4 Turning the Power ON/OFF.....	3-8
3.5 Connecting the DUT .....	3-12
3.6 Alignment Adjustment.....	3-13
3.7 Wavelength Calibration .....	3-15
3.8 Important Points During Measurement.....	3-20

## Chapter 4 Common Operations

4.1 Description of Soft Keys .....	4-1
4.2 Using the Mouse and External Keyboard.....	4-3
4.3 Entering Numerical Values and Strings.....	4-5
4.4 Screen Display .....	4-7
4.5 Setting the Date and Time.....	4-8
4.6 Printing Out Using the Internal Printer (Optional).....	4-9

## Chapter 5 Measurement

5.1 Auto Measurement .....	5-1
5.2 Horizontal/Vertical Axis Settings.....	5-2
5.3 Sub Scale .....	5-7
5.4 Setting the Reference Level .....	5-11
5.5 Center Wavelength (Center Frequency) Setting .....	5-15
5.6 Sweep Width Settings .....	5-20
5.7 Wavelength (Frequency) Resolution Settings .....	5-24
5.8 Sampling Point/Interval Settings .....	5-27
5.9 Sensitivity Settings .....	5-29
5.10 Averaging Times Setting.....	5-31
5.11 Trace Settings .....	5-32
5.12 Measurement Start (Sweep) .....	5-34

## Contents

---

5.13	Specifying a Sweep Range .....	5-36
5.14	Pulse Light Measurement.....	5-37
5.15	External Trigger Measurement.....	5-39
5.16	Trigger Output .....	5-42
5.17	Synchronous Sweep Measurement with the Tunable Laser Source.....	5-43
5.18	Analog Out .....	5-47

### Chapter 6 Waveform Display

6.1	Zooming In/Out on Waveforms.....	6-1
6.2	Wavelength Updating/Fixing.....	6-8
6.3	MAX/MIN HOLD Display .....	6-10
6.4	Sweep Average .....	6-11
6.5	Displaying Calculated Waveforms.....	6-13
6.6	Normalized Display .....	6-18
6.7	Curve Fitting .....	6-19
6.8	Marker Display .....	6-25
6.9	Displaying a Split Screen .....	6-36
6.10	Noise Mask.....	6-38
6.11	Copying and Clearing Traces .....	6-40
6.12	Searching .....	6-42

### Chapter 7 Analysis

7.1	Spectrum Width Measurement.....	7-1
7.2	Notch Width Measurement.....	7-4
7.3	SMSR Measurement .....	7-6
7.4	POWER Measurement.....	7-8
7.5	DFB-LD, FP-LD, and LED Measurement .....	7-9
7.6	PMD Measurement .....	7-10
7.7	WDM Transmission Signal Analysis .....	7-12
7.8	Optical Amp Gain and NF Measurement.....	7-19
7.9	Optical Filter Characteristics Measurement .....	7-26
7.10	Editing the Grid Table .....	7-35
7.11	Measurement of Level Fluctuations in Single-Wavelength Light (0 nm Sweeping).....	7-39
7.12	Go/No-Go Judgment (Template) .....	7-42
7.13	Specifying an Analysis Range .....	7-54
7.14	Correcting Displayed Values .....	7-57

### Chapter 8 Saving/Loading Data

8.1	USB Storage Media.....	8-1
8.2	Temporarily Saving and Redisplaying Traces to and from Internal Memory .....	8-2
8.3	Saving/Loading Displayed Data .....	8-6
8.4	Saving/Loading Setting Data.....	8-21
8.5	Saving/Loading Analysis Results Data.....	8-26
8.6	Saving/Loading Program Data .....	8-34
8.7	Saving Screen Image Data .....	8-40
8.8	Saving/Loading Template Data.....	8-44
8.9	Creating Files .....	8-50

**Chapter 9 Other Operations**

9.1 Registering Soft keys ..... 9-1  
 9.2 Data Initialization ..... 9-2  
 9.3 Help ..... 9-15  
 9.4 Registering and Loading Character Strings ..... 9-16  
 9.5 Other Settings ..... 9-17

**Chapter 10 Maintenance**

10.1 Upgrading the Firmware ..... 10-1  
 10.2 Mechanical Inspection ..... 10-3  
 10.3 Operational Inspection ..... 10-4  
 10.4 Inspection of Wavelength Accuracy ..... 10-5  
 10.5 Inspection of Level Accuracy ..... 10-6  
 ⚠ 10.6 Replacing Fuses ..... 10-7  
 10.7 Daily Maintenance ..... 10-8  
 10.8 Care during Storage ..... 10-10  
 10.9 Recommended Replacement Parts ..... 10-11  
 10.10 Warning Display Function ..... 10-12

**Chapter 11 Specifications**

11.1 Specifications ..... 11-1  
 11.2 External Dimensions ..... 11-4

**Appendix**

Appendix 1 GRID Table for WDM Wevelength ..... App-1  
 Appendix 2 Data Calculation Algorithms for Spectrum Widths ..... App-2  
 Appendix 3 Details of Each Analytical Functions ..... App-11  
 Appendix 4 Detailed Explanations of WDM Analysis Function ..... App-18  
 Appendix 5 Details of Optical Amplifier Analysis Function ..... App-29  
 Appendix 6 Details of Optical Filter Analysis Function ..... App-32  
 Appendix 7 Soft Key Tree Diagram ..... App-49  
 Appendix 8 END USER LICENSE AGREEMENT ..... App-67

**Index**

# 1.1 Front Panel

## Front Panel

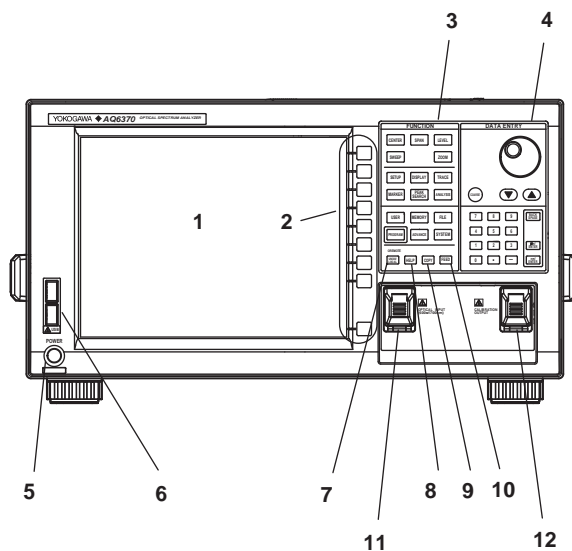

No.	Name	Function
1	LCD display	Displays measured waveform, measurement conditions, measurement values, etc.
2	Soft key section	Used to execute the functions assigned to the soft keys on the right side of the LCD display
3	FUNCTION section	Used to enter settings pertaining to all measurements (sweep, measurement conditions, data analysis, and various functions)
4	DATA ENTRY section	Used for measurement condition parameter input, label input, etc.
5	POWER	Used to start and shut down the instrument.
6	USB1.1 interface	Used to connect USB storage media
7	UNDO/LOCAL	See the following table(1.3 Panel keys and Knobs)
8	HELP	Used to check the contents of the soft key menu displayed on the screen.
9	COPY	Used to make hard copies of the screen through the internal printer (optional)
10	FEED	Used to feed recording paper
11	OPTICAL INPUT	Optical input connector
12	CALIBRATION OUTPUT	Reference light source optical output connector used for alignment adjustments and wavelength calibration

## 1.2 Rear Panel

### Rear Panel

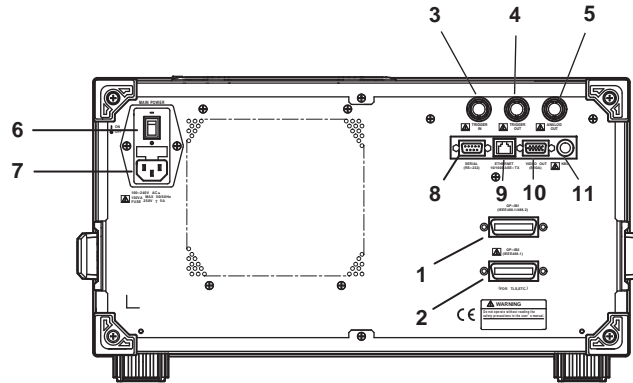

No.	Name	Function
1	GP-IB1	GP-IB port for controlling this unit through an external computer
2	GP-IB2	GP-IB port that allows this unit to serve as a system controller on the GP-IB bus for controlling an external device
3	TRIGGER IN	Input connector for synchronous signals for the synchronous measurement function with the Tunable Laser Source
4	TRIGGER OUT	Output connector for synchronous signals for the synchronous measurement function with the Tunable Laser Source
5	ANALOG OUT	Analog output
6	MAIN POWER	Used to turn the main power ON/OFF
7	Power cord connector	Connect the power cord to this connector
8	SERIAL	RS-232 interface
9	ETHERNET	Ethernet Interface (10/100BASE-TX)
10	VIDEO OUT (SVGA)	Analog RGB video signal (SVGA-compliant) interface
11	KBD	External keyboard interface (PS/2)

## 1.3 Panel Keys and Knobs

### FUNCTION Section

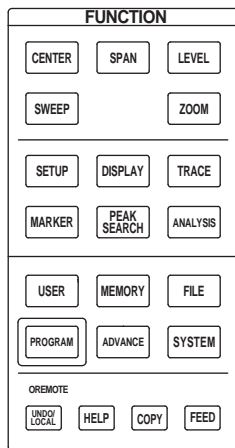

The FUNCTION section contains 17 function keys and 4 auxiliary keys. When you press a function key, information about the function is displayed on the soft key menu located on the right side of the LCD display.

#### SWEEP

The SWEEP key contains functions related to sweeping. When you press the SWEEP key, the soft key menu for sweeping appears.

#### CENTER

The CENTER key contains functions related to setting the center wavelength and center frequency for measurements. The soft key functions change depending on whether the screen display mode is wavelength display mode or frequency display mode.

#### SPAN

The SPAN key contains functions pertaining to settings for the wavelength span or frequency span being measured. The soft key functions change according to whether the screen display mode is wavelength display mode or frequency display mode.

#### LEVEL

The LEVEL key contains functions related to level axis settings. When you press the LEVEL key, the soft key menu for setting reference level appears.

#### SETUP

The SETUP key contains functions related to measurement condition settings.

#### ZOOM

The ZOOM key contains the zoom function, which allows the user to freely enlarge or reduce a measured waveform in order to check a small area of the measured waveform, or to check the overall waveform.

This key is used to set the waveform enlarged/reduced display conditions.

#### DISPLAY

The DISPLAY key contains functions related to screen display. This key is used to set the screen to upper/lower 2-split display mode (split mode).

#### TRACE

The TRACE key contains functions related to trace mode settings.

#### MARKER

The MARKER key contains functions related to markers.

#### PEAK SEARCH

The PEAK SEARCH key contains functions for searching for peaks and bottoms in measured waveforms.

#### ANALYSIS

The ANALYSIS key contains functions related to measured waveform analysis.

**MEMORY**

The MEMORY key contains functions for writing the contents of the active trace to the unit's internal memory. When you press the MEMORY key, the traces and memory list screen (soft key menu) are displayed. A memory number may be entered in the DATA ENTRY section, or selected using the rotary knob or arrow keys.

**FILE**

The FILE key contains functions for saving and loading waveform data, program data, and the like to and from USB storage media (USB memory/HDD).

**PROGRAM**

The PROGRAM key contains the soft keys related to program functions for controlling measurements through a program.

**SYSTEM**

The SYSTEM key contains system-related functions such as monochromator adjusting optical alignment, wavelength adjustment, hardware setup, and setting initialization.

**ADVANCE**

The ADVANCE key contains functions related to template function settings.

**USER**

Frequently used soft keys can be registered on the soft key menu in the USER key. Registering frequently used soft keys in the USER key allows you to execute frequently used functions in a small number of steps.

**COPY/FEED**

The COPY key is used to output the measurement screen to the internal printer or a file. When you press the COPY key, the measured waveforms and lists displayed on the screen are output to the internal printer or a file.

The FEED key is used to feed printer paper. Paper feeding continues as long as you hold down the FEED key.

**UNDO/LOCAL**

The key's function changes depending on the status of the instrument when the UNDO/LOCAL key is pressed. The following table shows the key's functions.

Status of Instrument	Function
UNDO action is allowed	If the UNDO key is pressed after changing parameter settings, changing or deleting data, etc., the previous action (change, deletion, etc.) is canceled and the state preceding that action is restored.
During user key registration	If the UNDO key is pressed during user key registration, registration mode is canceled and the soft key menu which appeared when the SYSTEM key was pressed is displayed again.
During remote control by external PC (Remote light is on)	Changes the state from the remote state back to the local state. The remote light turns off.

**HELP**

When you press the HELP key, a soft key menu of the currently displayed screen is displayed explanations.

Soft keys for selecting the "MORE INFO" which indicate additional information are displayed by some soft keys in HELP screen.

## DATA ENTRY Section

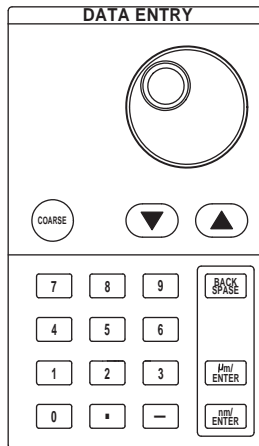

This unit allows you to enter measurement conditions and various other parameters through the DATA ENTRY section. Three different entry methods can be used in the DATA ENTRY section, the rotary knob, the arrow keys, and the numeric keypad.

### Rotary knob

When you press a soft key which has a parameter, the current setting is displayed in the parameter entry window. Turning the rotary knob raises or lowers the numeric value shown in the parameter entry window (turn clockwise to increase and counterclockwise to decrease), and the internal setting changes at the same time.

Note that if the COARSE key is on (lamp on), the numeric value increase/decrease step will be larger.

### Arrow keys (▲, ▼)

Pressing the ▲ key has the same effect as turning the rotary knob clockwise. Likewise, pressing the ▼ key has the same effect as turning the rotary knob counterclockwise.

Holding an arrow key down for 0.5 second or longer activates auto-repeat.

If the multi-marker function has been selected, the arrow keys can be used to scroll the marker value display in the data area.

### COARSE Key

You can raise the digit of settings being entered or the increase/decrease step for numerical values.

Each time you press this key the setting toggles between ON and OFF. When ON, the lamp lights.

### Numeric keypad

You can enter numerical values directly into the parameter input window by pressing keys of the numeric keypad.

After you have pressed a parameter soft key to display the current setting in the parameter display area, you can press a numeric keypad key to display the numeric keypad input area including the entered numeric value.

If the value entered with the numeric keypad is not in the allowed value range, the nearest allowed value will be set.

### µm/ENTER Key and nm/ENTER Key

Enters values input using the numeric keypad or the parameter input window.

Use one or the other key if entering a parameter value with a particular unit.

If a parameter does not have a unit associated with it, you can use either the µm/ENTER key or the nm/ENTER key.

### BACK SPACE Key

Use this key if you make an error when inputting values with the numeric keypad. The last entered (right-most) character is removed, allowing entry of the correct character. By holding the BACK SPACE key down, you can erase the entire entry in the numeric keypad input area and make the numeric keypad input area disappear, returning it to the condition preceding numeric keypad input.

## 1.4 LCD Screen

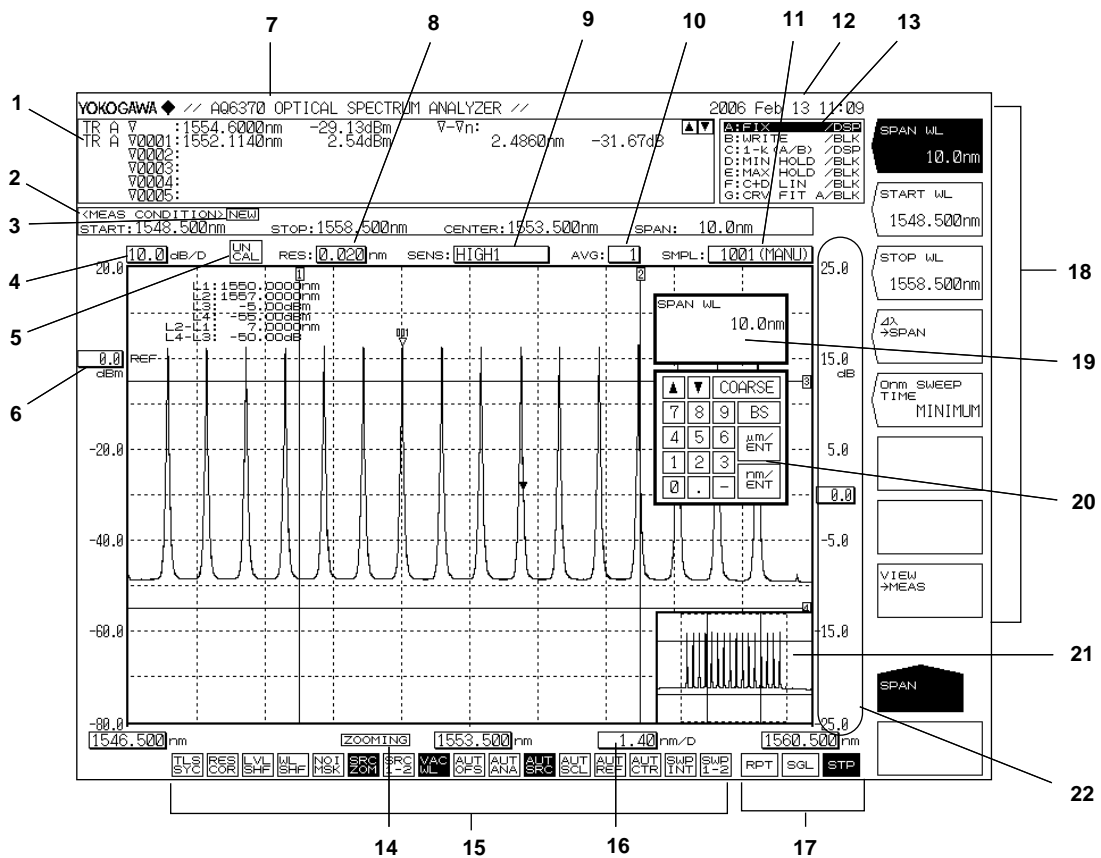

### No. Function

- 1 Data area
- 2 Measurement conditions area
- 3 **NEW** (Displayed when any of the measurement conditions are changed.)
- 4 Displays level axis scale per DIV
- 5 **UN CAL** (Displayed when measurement is not correctly carried out.)
- 6 Displays reference level
- 7 Label area (56 characters)
- 8 Displays wavelength resolution
- 9 Displays measurement sensitivity
- 10 Displays averaging times
- 11 Displays the number of measurement samples
- 12 Displays date and time
- 13 Displays each trace status
- 14 **ZOOMING** (Only displayed when ZOOM function is used)
- 15 Displays the statuses of main settings (When a setting is ON, its display is depressed, or is displayed with white on black background if the display colors are black and white.)
- 16 Displays wavelength axis scale per DIV
- 17 Displays sweep status (RPT=Repeat; SGL=Single; STP=Stop)
- 18 Displays soft key menu (Displays markers and data analysis results.)

- 19 Parameter display area
- 20 Parameter input area
- 21 OVERVIEW display screen  
(Only displayed when ZOOM function is used.)
- 22 Displays sub-scale

# 2.1 System Structure

## System Structure

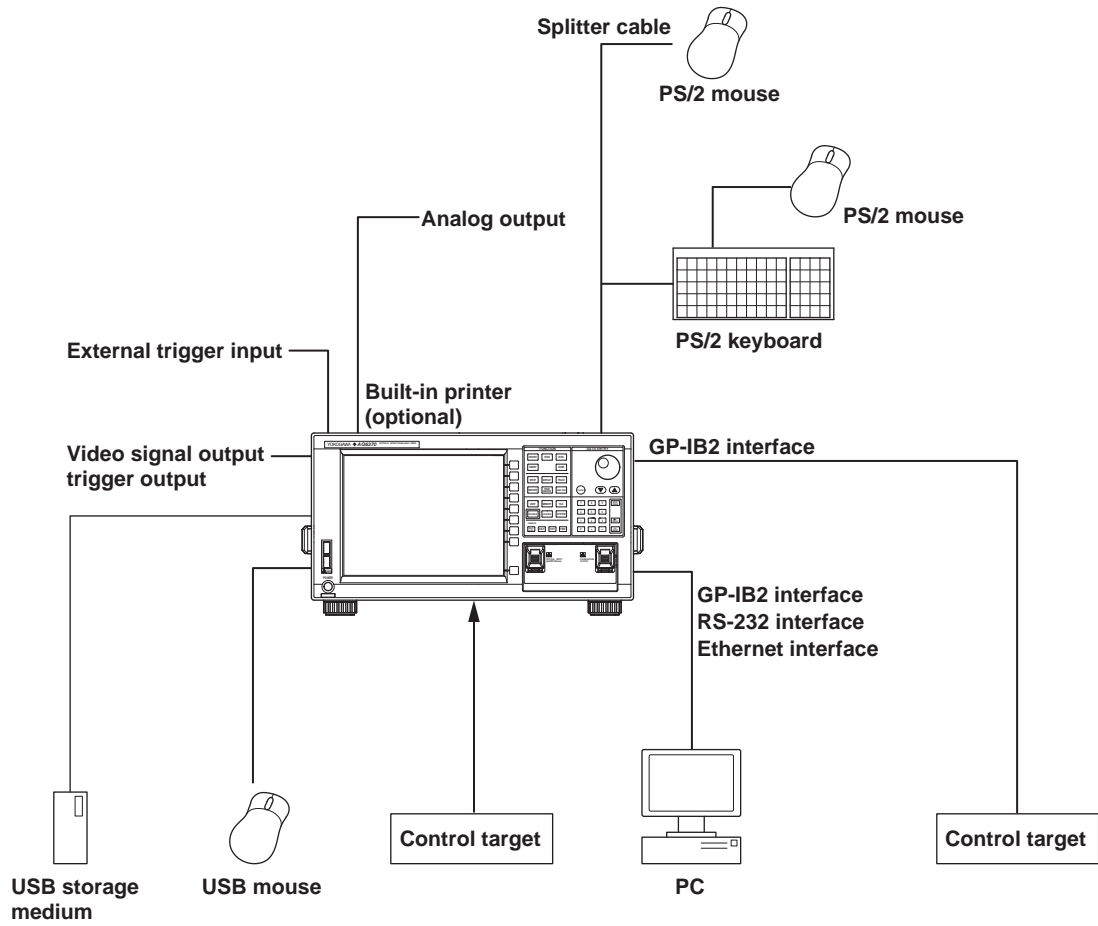

---

## 2.2 Measurement

### **Alignment Adjustment <<See section 3.6 for the operating procedure>>**

This function allows adjustment of the optical axis of the instrument's built-in monochromator (spectroscope).

The instrument's optical performance is not guaranteed until the alignment adjustment function has been executed. Failure to perform this adjustment can result in distortion of measured waveforms. After alignment adjustment has been executed, wavelength calibration is also subsequently performed automatically. If you are using the instrument for the first time or using it after it has been severely shaken while being moved, perform the alignment adjustment procedure after warm-up ends.

### **Wavelength Calibration <<See section 3.7 for the operating procedure>>**

Wavelength calibration can be performed using the internal reference light source or an external light source.

### **Auto Measurement <<See section 5.1 for the operating procedure>>**

This function automatically sets the optimal measuring conditions for the input light and displays the spectrum waveform. This function is useful when the characteristics of the input light are not well known.

The wavelength range of input light that can be auto-measured is 1200–1670 nm.

The measurement conditions that are set automatically are as follows.

1. Span (SPAN)
2. Center wavelength (CENTER)
3. Reference level (REF LEVEL)
4. Resolution (RESOLUTION)

Other measuring conditions (sensitivity, averaging times, number of sampling points, and interval settings) are set to their defaults. The horizontal and vertical axes of the displayed spectrum waveform are zoomed to an appropriate degree.

### **Single Sweep <<See section 5.12 for the operating procedure>>**

This function executes a single sweep or forcibly stops a sweep operation.

### **Repeat Sweep <<See section 5.12 for the operating procedure>>**

This function performs repeat sweeping or forcibly stops a sweep operation. It enables repeated, real-time measurement of waveforms.

### **Segment Measurement <<See section 5.12 for the operating procedure>>**

This function allows you to divide up items to be measured in units of previously specified segments.

Allows measurement delimited by segments (portions).

### **Synchronous Sweep <<See section 5.17 for the operating procedure>>**

This function links the turnable laser source connected to the GP-IB2 port with the sweep of the instrument. By synchronizing sweep with the turnable laser source, measurement of high resolution and optical dynamic ranges can be obtained when measuring the wavelength loss characteristics of optical filters, optical fiber gratings, and other items.

Higher resolution can be obtained since the wavelength resolution is being determined by the spectral line width of the tunable laser source. Also, since the tunable laser source scarcely outputs any other components than the measuring wavelength, and as the noise light which comes out faintly is being totally cut except for the section corresponding to the resolution range of this equipment, an extremely high optical dynamic range can be acquired.

This instrument can execute synchronous sweep with the following tunable laser sources.

- AQ4321 Series Tunable Laser Source
- AQ2200-136 Tunable Laser Source

### One-Action Keys <<See section 5.4 to 5.6 for the operating procedure>>

This is the general name for a key that uses data from the active trace waveform (the currently displayed waveform) to set measurement conditions.

Setting conditions requires that a waveform is displayed for the active trace.

One-Action Key Name	Description
PEAK → REF LEVEL	Sets the peak level of the measured waveform of the active trace as the reference level.
MARKER → REF LEVEL	Sets the moving marker level as the reference level.
PEAK → CENTER	Sets the peak wavelength or the peak frequency of the active trace measurement waveform to center wavelength or center frequency.
MEAN WL → CENTER	Sets THRESH 3 dB center wavelength or center frequency of the active trace measured waveform to center wavelength or center frequency.
VIEW → MEAS	Sets the currently displayed ZOOM scale as the measurement scale (CENTER, START, STOP, SPAN) for the next sweep.
MARKER → CENTER	Sets the wavelength of the moving marker to center wavelength or center frequency.
$\Delta\lambda$ → SPAN	Sets the sweep width as six times the RMS 20 dB width of the active trace measurement waveform.
MKR L1-L2 → SPAN	Sets spacing between line markers 1 and 2 for sweep width.
PEAK → ZOOM CTR	Sets the peak wavelength of the active trace measurement waveform to center wavelength or center frequency of zoom display.
MARKER → ZOOM CTR	Sets the wavelength of the moving marker to center wavelength or center frequency of zoom display.
MKR L1-L2 → ZOOM SPAN	Sets spacing between line markers 1 and 2 for sweep width of zoom display.

### Switching between Vacuum Wavelength and Air Wavelength

#### <<See section 5.2 for the operating procedure>>

This function switches the measured wavelength to either a vacuum wavelength or an air wavelength.

Measurement can be performed in either air or vacuum wavelength mode.

### Switching between Wavelength and Frequency

#### <<See section 5.2 for the operating procedure>>

This function switches the horizontal axis display to wavelength or frequency.

You can display either the wavelengths or frequencies of marker values and analysis results.

### **Averaging <<See section 5.10 for the operating procedure>>**

This function performs multiple measurements and displays the average values. The function is used in cases such as: when the light source's level is fluctuating; when measuring a modulated signal of several kHz or less; when the waveform is disrupted and difficult to measure; when it is necessary to obtain even higher measurement sensitivity.

### **Power Density Display <<See section 7.4 for the operating procedure>>**

The power per 1 nm is called the power density. The level axis of the AQ6370 indicates the absolute power per wavelength resolution. For example, if the resolution is set to 0.1 nm, the power per 0.1 nm will be displayed. Since the optical spectrum of such devices as a gas laser or a laser diode is narrower than the wavelength resolution of the instrument, the entire power is accommodated within the band of a resolution. Therefore, the measured power (peak level) is equal to the total power of the light source. This instrument has been calibrated to display accurate power under such conditions.

On the other hand, natural light or lights such as fluorescent lamps or LEDs, have, in many cases, optical spectrums wider than the wavelength resolution set for the instrument. Therefore, if the instrument measures these lights, measured power will vary, depending on the resolution setting.

In order to deal with this issue, the instrument is equipped with the dBm dBm/nm soft key to allow the level axis displays to switch from the absolute power (dBm, mW,  $\mu$ W, nW, pW) per resolution to power density (dBm/nm, mW/nm,  $\mu$ W/nm, nW/nm, pW/nm). In the case of power density displays, a measured value is converted to power per 1 nm. Therefore, whatever resolution is used for measurement, certain measured values will always be available.

Differences in usage between the absolute power display and the power density display are shown below:

Absolute power display: measurement of light sources with narrow spectrum widths, such as gas lasers or laser diodes.

Power density display: measurement of light sources with wide spectrum widths, such as natural light or LEDs.

If the subtraction function between traces is used for such cases as  $A-B(A/B) \rightarrow C$  or  $B-A(B/A) \rightarrow C$ , results will be the same whether the absolute power display or the power density display is used.

Since the power measurement function performs different calculations according to the level axis display, correct results will be available whichever display is employed.

Note that, if the NF measurement function (ANALYSIS 2 EDFA-NF soft key) and the WDM analysis function (ANALYSIS 2 WDM soft key) are executed, the level axis display will be forcibly changed to the absolute power display.

#### **Note**

---

Specifications such as level accuracy, measurement level range, and level linearity of the instrument are provided for the absolute power display.

---

## External Trigger Measurement <<See section 5.15 for the operating procedure>>

This function performs measurement in synchronization with an external trigger signal. The SMPL TRG IN terminal is an input terminal on the TTL level and in positive/negative logic (which can be set by the <EXT TRIGGER SETTING> key). The SMPL TRG IN terminal is an input terminal for TTL level, positive/negative logic signals. The measurement points (wavelength/frequency) are incremented each time edges of input external trigger signals are detected. Thus, sweeping stops when a number of external trigger signals equaling the specified number of sampling points is input. (However, when the REPEAT sweep is performed, the sweep will be repeated until the **STOP** key is pressed or until trigger signals are no longer input.)

The delay time (from the time when a trigger signal is detected until the time when the sampling is performed) specific to the instrument is about 20  $\mu\text{s}$ . Supply the trigger signal at a timing appropriate for the measurement sensitivity. An optional delay time can be set to this specific delay time. With the DELAY key of the EXT TRIGGER SETTING key, the 0.0  $\mu\text{s}$  to 1000.0  $\mu\text{s}$  range can be set in units of 0.1  $\mu\text{s}$ .

Note that after the measurement points are set, input trigger signals during the movement to the next measurement point are ignored. The time varies depending on the measurement wavelength band and the number of sampling points (sampling intervals). Since the SMPL TRG IN terminal is pulled up internally, it can be set to the HIGH level while it is in the open state and to the LOW level while it is in the GND short state.

## Sweep Trigger <<See section 5.15 for the operating procedure>>

This function performs a single sweep measurement based on an externally input trigger signal.

The instrument starts a single sweep measurement by allowing sweep trigger signals on the TTL level and in negative logic to enter the TRIGGER IN terminal at the back of the instrument.

The signal logic of the sweep trigger input signals is fixed to negative logic, which cannot be changed.

The pulse width of sweep trigger signals must be 5 ms or more.

The action when entering a sweep trigger is the same as that for the SWEEP key or SINGLE key.

The sweep trigger function detects sweep trigger signals by polling in certain cycles.

Thus, the time after a sweep trigger signal is input until the sweep starts will fluctuate in the range of 5 ms.

## Trigger Output <<See section 5.16 for the operating procedure>>

This function outputs trigger signals from the trigger output terminal on the rear panel of the instrument (only during sweeping).

**Analog Out <<See section 5.18 for the operating procedure>>**

An analog voltage is output from the ANALOG OUT terminal on the rear panel of the main unit according to the input light.

The temporal changes in the input light can be measured by an oscilloscope.

However, to enable this output, the sensitivity setting must be NORM/HOLD.

When set to NORM/HOLD, the RANGE is switched relative to the REF LEVEL without implementing the AUTORANGE function. Therefore, if the level of the input light is high, the output voltage level is saturated.

The saturation level and noise level varies depending on the REF level.

The table below shows the relationship between the REF level and the saturation level.

REF LEVEL(dBm or dBm/nm)	Saturation Level * (dBm)
REF > 0	23 dBm or more
0 <= REF > -10	13 dBm or more
-10 <= REF > -20	3 dBm or more
-20 <= REF > -30	-7 dBm or more
-30 <= REF	-17 dBm or more

\* At wavelength 1450 to 1620 nm

**ANALOG OUT Output Specifications**

Output saturation voltage	+6 V or more
Offset voltage (including noise)	±5 mVp-p
Bandwidth	10 kHz or more
Load	1 kΩ or more

## 2.3 Waveform Display

### Zoom

<<See section 6.1 for the operating procedure>>

This function allows you to zoom freely in and out on measured waveforms.

You can easily zoom an area simply by selecting it with the mouse. Drag the mouse over an area of the displayed waveform to zoom in on the area. ZOOMING is displayed at the bottom of the screen to indicate that the screen is displaying a zoomed area. You can also zoom in and out with key operations.

### Overview

<<See section 6.1 for the operating procedure>>

This function displays an overview window at the very bottom of the waveform display area. The overview window is displayed when the waveform display is enlarged or reduced using the zoom function. (Only displayed when a zoom is performed.)

You can easily check which part of the measured waveform is zoomed. The overview window can be shown or hidden, and you can change its position and size.

### Trace

<<See section 5.11 for the operating procedure>>

A trace shows a waveform and measurement conditions. The instrument has a total of seven independent traces (A through G). Multiple traces can be displayed at the same time on the waveform screen. In addition, display ON/OFF and mode settings can be set separately for each trace.

Traces can be set to the following modes.

- WRITE mode                      Section 6.2
- FIX mode                              Section 6.2
- MAX/MIN HOLD mode      Section 6.3
- ROLL AVG mode              Section 6.4
- CALCULATE mode              Section 6.5

The following explains each of the modes.

#### WRITE Mode

Waveform data are written during sweeping.

When a trace is set to WRITE mode, waveform data are written during measurement, and the data are updated. Traces used in measurements are normally set to WRITE mode. The trace display at the side of the data area changes to "WRITE."

#### FIX Mode

Fixes the data; does not write waveform data.

When a trace is set to FIX mode, its waveform data are not overwritten even when measurement is performed. Therefore, the waveform on the screen is not overwritten. If you want to fix the waveform data of a trace, set the trace to FIX mode. The trace display at the side of the data area changes to "FIX."

### **MAX/MIN HOLD Mode (Maximum/Minimum Value Detection Mode)**

Writes the maximum/minimum values of the waveform data for each sweep.

When a trace is set to MAX/MIN HOLD mode, each time a sweep is performed, the data at the individual measurement points are compared with prior measurements, and the measurement with the higher level (MAX HOLD) or lower level (MIN HOLD) is written. If you want to measure the maximum or minimum value of a waveform which changes each time a sweep is performed, set the trace you want to measure to MAX/MIN HOLD mode and perform REPEAT sweeping.

The trace display at the side of the data area appears as "MAX HOLD" or "MIN HOLD". Note that the NOISE MASK soft key setting applies when a waveform is displayed, and is not affected when a maximum or minimum value is detected.

### **ROLL AVG Mode (Rolling Average Mode)**

Writes the rolling average values of the waveform data during each sweep.

When a trace is set to ROLL AVG mode, each time measurement is performed the rolling average of the current measurement and past measurements is calculated, and the measurement data are updated. The number of averagings is set in the range of 2 to 100. The trace display at the side of the data area changes to "ROLL AVG".

### **CALCULATE Mode (Calculation Results Display)**

Writes the results of calculations performed between data from different traces.

When a trace is set to CALCULATE mode, subtraction between data from different traces, normalized display, or curve-fit display is performed according to the set CALCULATE mode. Note that CALCULATE mode can only be set for traces C, F, and G. Also, the available calculations vary from trace to trace. For more information, see chapter 6.

### **Normalized Display Function <<See section 6.6 for the operating procedure>>**

This function is one of the trace CALCULATE modes. It normalizes and displays the trace data.

With normalized display, normalization is performed and the waveform is displayed with the waveform peak set to 1 if the sub-scale is linear, or set to 0 dB if the sub-scale is LOG. One trace can be normalized, either trace A, B, or C. If both traces selected for calculation are set to "BLANK", then the sub-scale is displayed on the left side of the screen. Otherwise it is displayed on the right side. The calculation results are displayed in the sub-scale. The trace display at the side of the data area changes to "NORM @".

### **Curve Fit**

#### **<<See section 6.7 for the operating procedure>>**

Makes an approximation of the specified trace waveform. The result is written to TRACE G. Calculations are applied to data from the peak to the threshold value. The threshold value is set in the range of 0 to 99 dB (steps of 1). The trace display at the side of the data area changes to "CRV FIT @."

### **Peak Curve Fit**

#### **<<See section 6.7 for the operating procedure>>**

Makes an approximation of the specified trace waveform. The result is written to TRACE G. Calculations are applied to mode peaks at or above the threshold value. The threshold value is set in the range of 0 to 99 dB (steps of 1). The trace display at the side of the data area changes to "PKCVFIT @".

**Marker Functions <<See section 6.8 for the operating procedure>>**

Marker functions can be used to easily measure wavelength differences and level differences, and to search for peak wavelengths, peak levels, and spectrum widths. There are markers and line markers.

**Markers**

A total of 1025 markers (one moving marker and 1024 fixed markers) are provided. Moving markers can be moved to an arbitrary wavelength using the rotary knob, arrow keys, or numeric key pad. You can also drag the markers with the mouse. Moving markers can be moved over a waveform to display the marker values (wavelength and level value) in the data area. If a moving marker is fixed in an arbitrary position, it changes to a fixed marker.

Fixed markers are markers fixed to a number on which the moving marker was set. Fixed markers are assigned marker numbers in order starting from 001. You can enter an arbitrary number using the rotary knob, arrow keys, or numeric key pad. A number up to 1024 can be set. When multiple fixed markers are set, it is possible to display wavelength differences and level differences between a given marker and adjacent markers.

**Line Markers**

There are four line markers—two wavelength line markers and two level line markers. Wavelength line markers show wavelength and wavelength difference, and level line markers show level values and level difference. Also, you can use line markers to specify a sweep or analysis range.

**Displaying Wavelength Difference and Level Difference**

This function places a fixed marker and measures the wavelength difference and level difference compared to a moving marker.

**Note**

---

For details, see the explanation in section 6.8, "Displaying Markers."

---

**Displaying Line Markers**

When line markers are displayed, the marker values are shown in the upper left part of the waveform area.

When both wavelength line markers 1 and 2 are displayed, or both level line markers 3 and 4 are displayed, the wavelength difference (L2-L1) or level difference (L4-L3) is shown below the marker values.

**Note**

---

For details, see the explanation in section 6.8, "Displaying Markers."

---

**Split Display****<<See section 6.9 for the operating procedure>>**

You can split the screen into an upper and lower display (SPLIT mode).

You can assign trace waveforms to either the upper or lower split.

TRACE A UP/LOW

This function is used to set whether to put trace A on top or on bottom during upper/lower split display. If you select UP, it is assigned to the top. (Default) If you select LOW, it is assigned to the bottom.

### **Noise Mask <<See section 6.10 for the operating procedure>>**

This key is used to display a waveform so that parts of the waveform at or below the set value are masked. In addition, when a noise mask value is set, the waveform is overwritten in real time.

When you press the NOISE MASK soft key, the current noise mask value is displayed in the noise mask value setting screen. The allowed settings for the noise mask setting are OFF (-210 dBm), and the range from -100 to 0 dBm (fine: in steps of 1; coarse: in steps of 10).

### **Peak/Bottom Search <<See section 6.12 for the operating procedure>>**

Sets a moving marker at the waveform peak (maximum level value) or bottom (minimum level value), and displays that value. You can also search for the next peak or bottom.

There is also an auto search function that automatically performs peak/bottom searches each time sweeping is performed. It is very useful for purposes such as observing peak/bottom level changes during repeat sweeping.

## 2.4 Analysis

### Spectrum Width Analysis <<See section 7.1 for the operating procedure>>

You can display the spectrum width and center wavelength using the following four types of calculation.

- THRESH method
- ENVELOPE method
- RMS method
- PEAK RMS method

<See appendix 2, "Spectrum Width Data Calculation Algorithms" for a description of the spectrum width analysis algorithms and parameters.>

### Notch Width Measurement <<See section 7.2 for the operating procedure>>

With notch width measurement, it is possible to measure pass band width / notch width from the measured waveform of a filter with V-character type or U-character type wavelength characteristics.

<For a description of the notch width analysis algorithm and parameters, see appendix 2, "Data Calculation Algorithms for Spectrum Widths.">

### Device Analysis <<See section 7.3 and 7.4 for the operating procedure>>

Light source parameters can be analyzed from the measured waveform of each light source (DFB-LD, FP-LD, LED).

#### DFB-LD SMSR Measurement

The side-mode suppression ratio (SMSR) can be measured from the DFB-LD measured waveform.

#### FP-LD and LED TOTAL POWER Measurement

Optical power can be measured by integrating the measured waveform level measurements.

### PMD Measurement <<See section 7.6 for the operating procedure>>

It is possible to measure the polarization mode dispersion (PMD) of a DUT (such as an optical fiber) by using the instrument in combination with an analyzer, polarization controller, polarizer, and an amplified spontaneous emission (ASE) light source, high-output LED light source, or other wideband light source.

### WDM Analysis <<See section 7.7 for the operating procedure>>

You can analyze WDM transmission signals. You can also measure OSNR of a DWDM transmission system with 50 GHz spacing. Measurements of WDM signal wavelength, level, wavelength interval, and OSNR can be made collectively on up to 1024 channels, and the analysis results can be displayed in a data table.

### Optical Amp Analysis <<See section 7.8 for the operating procedure>>

Measurement can be performed of the optical amp gain and noise figure from measured waveform of the signal light going into the optical amp, as well as the measured waveform of the output light leaving the optical amp.

### Optical Filter Characteristics Measurement

**<<See section 7.9 for the operating procedure>>**

Optical filter characteristics can be measured from the measured waveform of the light input to the optical filter from the light source, as well as from the measured waveform light output from the optical filter.

Analysis can be performed not only on optical filters with only one mode, but also multi-mode WDM filters.

### Measurement of Level Fluctuations in Single-Wavelength Light

**<<See section 7.11 for the operating procedure>>**

This function is used to measure changes over time in the level of a specific wavelength level. The sweep width is set to 0 nm, and measurement of the single-wavelength light is taken. The horizontal axis is the time axes. It is useful for purposes such as optical axis alignment when a light source is input to an optical fiber.

### Template

**<<See section 7.12 for the operating procedure>>**

The template function compares preset reference data (template data) with a measured waveform. In addition, if a function for displaying the target spectrum (target line) on the measurement screen is used, the target spectrum can be referenced while adjusting the optical axis of an optical device.

The following three templates are provided.

- Upper limit line
- Lower limit line
- Target line

### Go/No Go Judgment <<See section 7.12 for the operating procedure>>

The Go/No Go test function compares the active trace waveform against reference data (template data) preset by the user, and performs a test on the measured waveform (Go/No Go test).

The template function can be used effectively in situations such as pass/fail tests on production lines.

### Analysis between Line Markers

**<<See section 7.13 for the operating procedure>>**

You can specify an analysis range with line markers. Analysis is performed in the range outlined by the two line markers.

### Analysis in the Zoom Area <<See section 7.13 for the operating procedure>>

You can specify the zoomed area as the analysis range.

For example, there is a zoom area power measurement function. This function calculates totalized power between display scales. It is effective for purposes such as ASE evaluation on optical amplifiers.

---

## 2.5 Other

### Using the USB Mouse <<See section 4.2 for the operating procedure>>

With a connected USB mouse you can perform the same operations as with the instrument's panel keys. Also, if you move the mouse pointer over the item in the menu screen that you wish to select and click it, the instrument responds exactly as if you had pressed the corresponding soft key.

The USB mouse is connected to the connector on the front panel of the instrument.

### Registering Soft Keys <<See section 9.1 for the operating procedure>>

Frequently used soft keys can be registered in the soft key menu.

Registering soft keys reduces the steps needed to execute their functions. Twenty-four soft keys can be registered. By default, all keys are unregistered.

### Data Initialization <<See section 9.2 for the operating procedure>>

You can restore all settings to their factory defaults.

The parameter setting values and data of each function are initialized.

### Help

#### <<See section 9.3 for the operating procedure>>

Displays an explanation of the soft key menus.

Certain soft keys have additional help text ("MORE INFO"). MORE INFO contains detailed explanations of the corresponding soft keys.

### Remote (Separate Document)

An external device can be connected to the instrument through the GP-IB port or another port to remotely control the instrument. This function requires a special connector cable for connecting with the external device. For details, see the separate user's manual, "Remote/Program Function."

### Program (Separate Manual)

The program function allows you to control an external instrument without using a PC. The function uses Ethernet, RS-232, or GP-IB. For details, see the separate user's manual, "Remote/Program Function."

## 3.1 Installing the Instrument

### CAUTION

Do not install the instrument in a non-horizontal orientation, and do not apply shock to it. This can adversely affect the accuracy of the internal monochromator (including during storage and transport).

### Installation Conditions

Install the instrument so that the following conditions are met.

#### Flat Horizontal Location

Place the instrument in a stable location that is flat in all directions. If the instrument is used in an unstable or angled surface, the accuracy of the internal monochromator can be compromised.

#### Location without Vibration

Do not install the instrument in a location subject to vibration. Use in a location that experiences large vibrations can lead to instability of operation, measurement stopping before completion, or notable decreases in accuracy of the wavelength and level axes.

#### Well Ventilated Location

Ventilation holes are present at the sides and rear of the instrument. To keep the internal temperature from rising, always maintain a gap of 200 mm or more between the ventilation holes and the installation surfaces.

Also be sure to maintain sufficient clearance for connecting measurement cables, and opening and closing the cover of the built in printer.

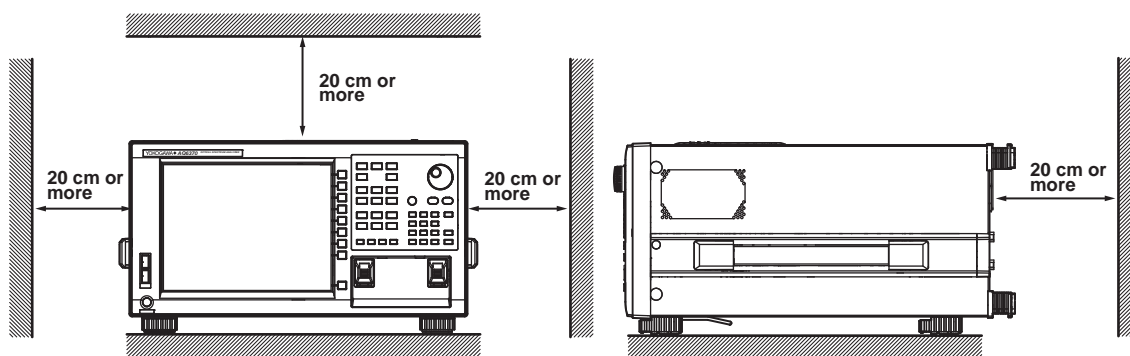

#### Ambient Temperature and Humidity

Ambient temperature: 5–35°C

Ambient humidity: 80% RH or lower (no condensation present)

#### Note

Condensation may occur if the instrument is moved to another place where the ambient temperature is higher, or if the temperature changes rapidly. In this case, let the instrument adjust to the ambient temperature for at least one hour before use.

#### **Do Not Install the Instrument in the Following Places**

- Dangerous locations where flammable or explosive gasses, vapors, or dust is present, or where the possibility of explosions or fires exists.
- In direct sunlight or near heat sources.
- Where an excessive amount of soot, steam, dust, or corrosive gas is present.
- Location where mechanical vibration is high.
- In an unstable place.

#### **General Handling Precautions**

- **Do Not Place Anything on Top of the Instrument**  
Never stack instruments or place any other objects on top of the instrument, especially those containing water. Doing so can lead to malfunction.
- **Do Not Apply Shock to the Instrument**
- **Take Proper Care When Carrying the Instrument**  
The instrument should always be carried by two people. Hold the instrument by the handles on the sides of the case. The instrument weighs approximately 27 kg. Take precautions against injuries when carrying it. Also, always turn the power switch OFF, remove the power cable, and confirm that no other cables are connected before carrying the instrument.
- **Clean the Instrument Properly**  
When removing dirt from the case or operation panel, disconnect the power to the circuits under test and the instrument, remove the instrument's power cord from the power outlet, then wipe gently with a clean, dry cloth. Do not use volatile chemicals since this might cause discoloring and deformation.

## 3.2 Attaching the Connector Adapter

Attach the optional connector adapter before using the instrument.

### Note

A different connector adapter is used for OPTICAL INPUT and CALIBRATION OUTPUT. Make sure not to use the wrong connector adapter.

### Attachment Procedure

1. Confirm that the power is OFF.
2. Open the optical connector cover at the front of the instrument.
3. Clean the ferrule edge of the optical I/O section using a swab soaked with a small amount of pure alcohol.
4. Insert the connector adapter all the way in.
5. Push the connector adapter's lock lever down.  
The adapter has been attached correctly if the groove in the lock lever interlocks with the latch pin of the optical input/output section.

### Removal Procedure

1. Confirm that the power is OFF.
2. Turn the connector adapter's lock lever up. The lock lever's lock is released.
3. Pull the connector adapter all the way out.
4. Close the optical connector cover at the front of the instrument.

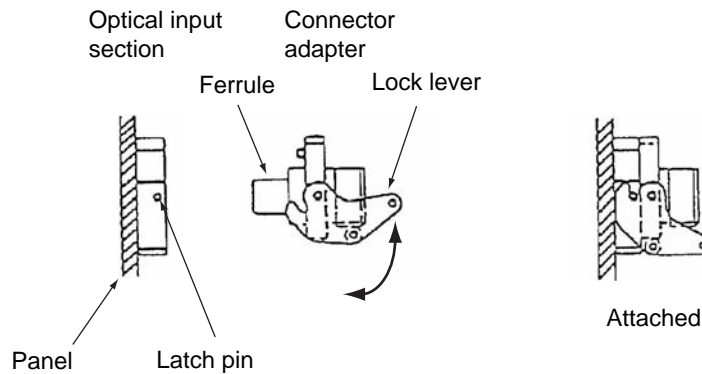

### CAUTION

- As there may be dust adhering to calibration output, be sure to clean it before attaching the connector adapter.
- Do not exhale or blow compressed air into the monochromator from the optical input. Doing so may allow dust or other materials to enter the monochromator, adversely affecting its optical performance. Also, if debris is adhering to the optical components inside the monochromator when a strong light source is input, the monochromator may be damaged.
- When attaching or removing the connector adapter, carefully insert it perpendicularly to the ferrule so as not to damage the ferrule end.
- Moving the connector adapter to the right or left or inserting it forcefully can damage the ferrule or the connector adapter.

**Explanation**

**Types of Connector Adapter**

The connector adapter for internal reference light output (AQ9441) comes in the following three types.

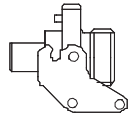

FC type

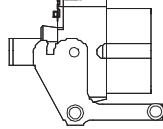

SC type

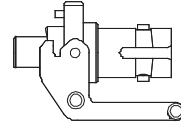

ST type

The optical input connector adapter (AQ9447) comes in the following three types.

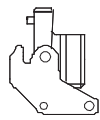

FC type

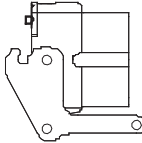

SC type

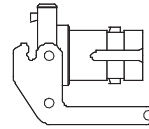

ST type

**Optical Connectors Types**

The instrument can use FC, SC, or ST type optical connectors.

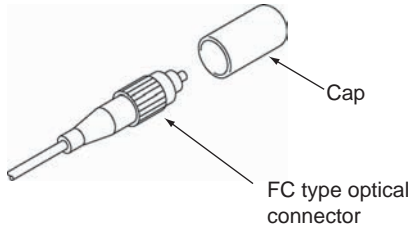

FC type optical connector

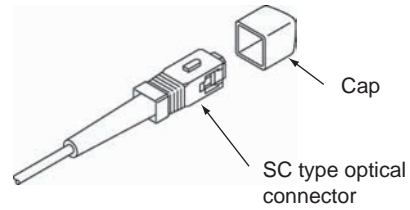

SC type optical connector

## 3.3 Connecting a Communication Interface

### Connecting the Mouse

You can use a USB or PS/2 mouse.

#### Supported USB Mouse

The instrument can support a USB HID Class Ver. 1.1 compliant mouse (with wheel).

#### Connections

The USB mouse is connected to the USB interface on the front panel of the instrument.

1. Confirm that **MAIN POWER** switch on the rear panel is OFF.
2. Orient the USB mouse connector in the proper direction so that it is perpendicular to the USB port on the front panel, and insert it into the port.

#### **Note**

- There are two USB ports, but do not connect a mouse to each port at the same time.
- In addition to a mouse, you can connect a USB storage device.

#### Supported PS/2 Mouse

The PS/2 wheel mouse by Microsoft® Corporation is recommended for this instrument.

#### Connections

The PS/2 mouse is connected to the KBD interface (PS/2 terminal) on the rear panel of the instrument through the keyboard.

1. Confirm that the **MAIN POWER** switch on the rear panel is OFF.
2. Orient the keyboard with the PS/2 mouse terminal to match the direction of the connector, then connect to the KBD interface on the rear panel.
3. Connect the PS/2 mouse to the PS/2 terminal on the keyboard.

#### **Note**

The default for the PS/2 terminal is the keyboard. To attach a PS/2 mouse directly without going through the keyboard requires a splitter cable.

For instructions on using the mouse, see section 4.2.

## Connecting a Keyboard

You can connect a keyboard for entering file names, comments, and other items. Also, the functions and settings of the instrument are assigned to keyboard keys, allowing you to manipulate them with a keyboard just as you would by using the instrument's panel keys.

### Supported Keyboards

The instrument supports any 101 English keyboard.

### Connections

Connect the keyboard to the KBD connector (PS/2 terminal) on the rear panel of the instrument.

1. Confirm that the **MAIN POWER** switch on the rear panel is OFF.
2. Orient the PS/2 keyboard to match the direction of the connector, then connect to the KBD connector on the rear panel.

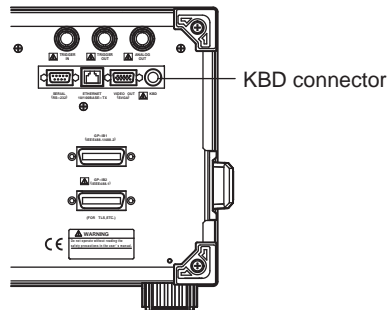

For information on operations using the keyboard, see section 4.2.

## Connecting a USB Storage Device

### Supported USB Storage Devices

The instrument supports USB memory (USB card adapters).

You cannot use a USB storage device not recognized by the instrument. If the USB storage device's drive is partitioned, only the primary partition (F:) is recognized. If there are two or more USB storage devices, only the first connected device is recognized.

### Connections

Connect the USB storage device to the USB connector on the front panel of the instrument.

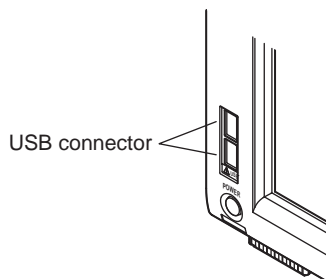

### Removing

See section 8.1. (Using the **REMOVE USB STORAGE** soft key.)

---

### CAUTION

---

Do not remove the USB storage device or turn the power OFF while the USB storage device access indicator is blinking. This can damage the data on the device or the device itself.

---

## Connecting with Other Devices

You can use the GP-IB, RS-232C, or Ethernet interface to connect other external instruments to the AQ. For details, see the user's manual of the relevant instrument.

### **Note**

When connecting a GP-IB instrument such as an external computer, or a CRT or other display to the instrument, always turn OFF the power to the instrument and the instruments to be connected first. Leaving the power ON while making connections can damage the equipment.

---

---

## 3.4 Turning the Power ON/OFF

### Before Connecting the Power

Take the following precautions before turning on the power supply. Failure to do so can result in electric shock or damage to instruments.

---

#### WARNING

- Before connecting the power cord, ensure that the power supply source voltage matches the rated supply voltage of the instrument and that it is within the maximum rated voltage of the provided power cord.
- Check that the instrument's power switch is OFF before connecting the power cord.
- To prevent the possibility of electric shock or fire, always be sure to use the power cord supplied for the instrument by YOKOGAWA.
- Make sure to implement protective earth grounding to prevent electric shock. Connect the instrument's power cord into a three-prong electrical outlet with a protective grounding terminal. The AC outlet must be of a three-prong type with a protective earth ground terminal.
- Do not use an extension cord without protective earth ground. Otherwise, the protection function will be compromised.
- Use an outlet that is compatible with the accessory power cord, and be sure to connect protective grounding. Do not use the instrument if the power outlet does not provide appropriate protective grounding.

### Preparing to Turn ON the Power

The AQ6370 has a **MAIN POWER** switch for turning the main power ON/OFF, and a **POWER** switch for starting and shutting down the instrument. **The POWER** switch is a push-button switch; press once to turn it ON and press again to turn it OFF.

- Confirm that the **MAIN POWER** switch on the rear panel of the instrument is OFF.
- Make sure the voltage of the power outlet matches the instrument's supply voltage.
- Before replacing a fuse, always turn the **MAIN POWER** switch OFF and remove the power cord from the power outlet.

---

#### CAUTION

Do not input a strong light source to the instrument when turning the power ON. If a strong light source is input, the optical section can be damaged.

---

## Power On and Screen Display

1. Connect the power cord to the power cord connector on the back side of the instrument.

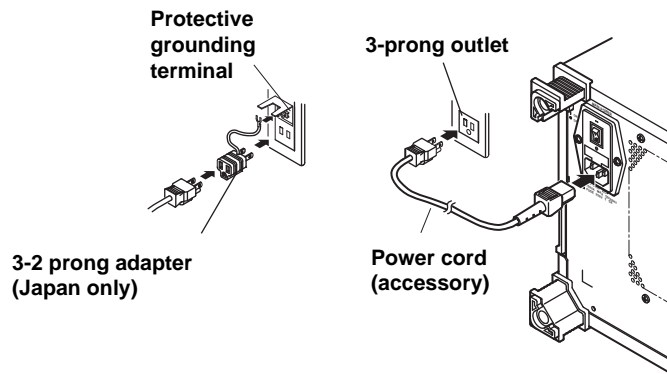

2. Turn ON the **MAIN POWER** switch on the rear panel of the instrument. The **POWER** switch on the front panel of the instrument lights orange.

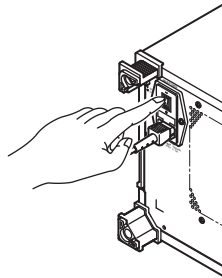

3. Press the **POWER** switch on the front panel of the instrument. The color of the switch turns from orange to green. The operating system starts up, and initialization of the instrument begins.

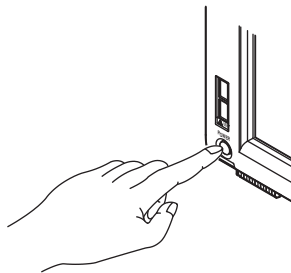

The initialization screen appears, and the internal initialization process starts. STEP 1/9 through STEP 9/9 are displayed in the lower right part of the screen to indicate the progress of initialization.

### CAUTION

Do not press the POWER or MAIN POWER switches while initialization is in progress.  
Doing so can cause malfunction.

### 3.4 Turning the Power ON/OFF

If initialization finishes successfully, a message appears prompting you to execute wavelength calibration and alignment adjustment.

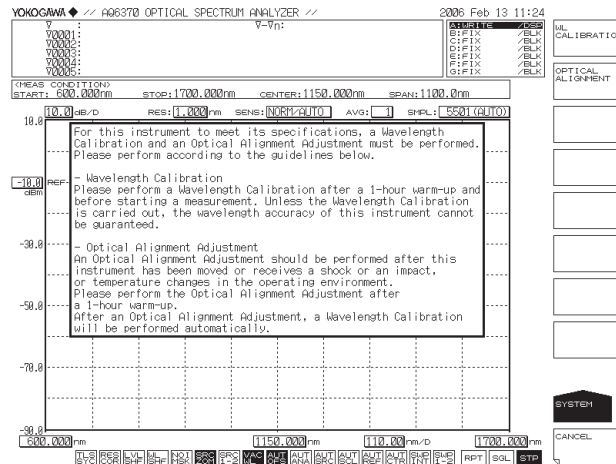

The contents of the message are as follows.

For this instrument to meet its specification, a Wavelength Calibration and an Optical Alignment Adjustment must be performed. Please perform these operations according to the guidelines below.

#### Wavelength Calibration

Perform wavelength calibration before starting measurement (a warm-up of one hour is also required prior to measurement). Unless the Wavelength Calibration is carried out, the wavelength accuracy of the instrument cannot be guaranteed.

#### Alignment Adjustment

Always perform alignment adjustment the first time you use the instrument, if the instrument was vibrated when being moved, or if the temperature in the operating environment has changed. Perform the alignment adjustment after a one-hour warm-up. See section 3.6 for details on the alignment adjustment operation, and 3.7 for wavelength calibration.

#### Note

- The instrument "remembers" measurement conditions, selected soft keys, waveforms being displayed, and other information. When the power is turned ON, the state of the instrument prior to the last shut down is restored. When the power is turned ON for the first time, the instrument starts up in the factory default state.
- If an abnormality occurs in memory or another part of the instrument part way through the initialization process, "STEP @/9" is displayed and the process stops (where @ is a number from 1 to 9). If this happens, the instrument requires servicing. Please contact your nearest dealership or sales representative immediately.

## Turning the Power OFF

1. Press the **POWER** switch on the front panel of the instrument. A shut down confirmation message is displayed along with the **YES** and **NO** soft keys.
2. Press the **YES** soft key. The message, "AQ6370 is shutting down. Please wait..." appears, and shut-down begins. If you do not wish to shut down, press the **NO** soft key. The screen returns to the original soft key menu.
3. After the **POWER** switch changes from green to orange, turn OFF the **MAIN POWER** switch on the rear panel of the instrument.

### CAUTION

Do not cut the power to the instrument with the **MAIN POWER** switch on the rear panel when an operation is in progress. The operating system configuration file will not be backed up, possibly resulting in malfunctions upon start up the next time the instrument is turned ON. Always use the above procedure to shut down.

You can also shut down the instrument using panel keys and soft keys.

1. Press **SYSTEM**.
2. Press the **MORE** soft key three times. The **SYSTEM 4/4** screen is displayed.
3. Press the **SHUT DOWN** soft key.
4. Press the **YES** soft key. Shut down begins.
5. After the **POWER** switch changes from green to orange, turn OFF the **MAIN POWER** switch on the rear panel of the instrument.

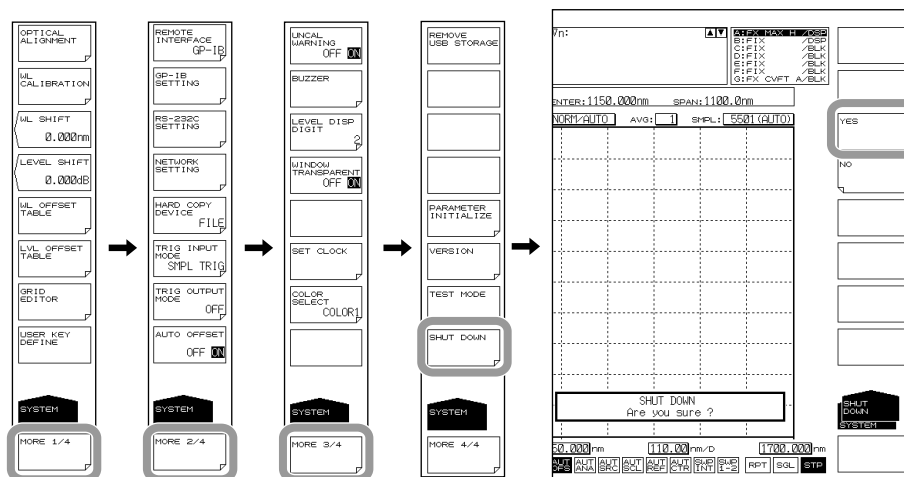

### Note

If for some reason the instrument fails to shut down normally, hold down the **POWER** switch for approximately four seconds or longer to force standby mode. Note that the operating system configuration file will not be backed up, possibly resulting in malfunctions upon start up the next time the instrument is turned on.

## 3.5 Connecting the DUT

### Procedure

#### Connecting Optical Fibers

1. Clean the tip of the optical fiber with a fiber cleaner.
2. Open the instrument's optical input connector cover.
3. Connect the optical fiber's optical connector to the optical input connector on the instrument.

### CAUTION

- Before connecting an optical fiber to the instrument, make sure that the start-up initialization process has finished. If a strong light source is input during start-up, the optical section can be damaged.
- Be sure to clean the tip of the optical fiber's optical connector before connecting.
- Do not try to forcefully attach the optical fiber's optical connector with the plug inserted at a slanted angle. Doing so may damage the instrument's optical connector's components or the connector itself.
- Before connecting the input light, make sure that it does not exceed the AQ6370's maximum rated level. If input light exceeding the maximum rated level is introduced, the optical section may be damaged.
- Slanted (angled) PC-type optical connectors cannot be used with the instrument. Forcefully connecting a slanted (angled) PC-type optical connector may damage the equipment. Always use optical fibers with a physical contact (PC) type optical connector.
- Press the optical connector hard against the cleaning surface of the special cleaner to clean it. If it is not pressed hard against the cleaning surface, it may not be possible to properly clean the optical connector.

#### Connecting the DUT (Light Source)

4. Clean the top of the optical connector on the other end of the optical fiber with a fiber cleaner.
5. Connect the optical connector on the other end of the optical fiber to the optical connector on the DUT.

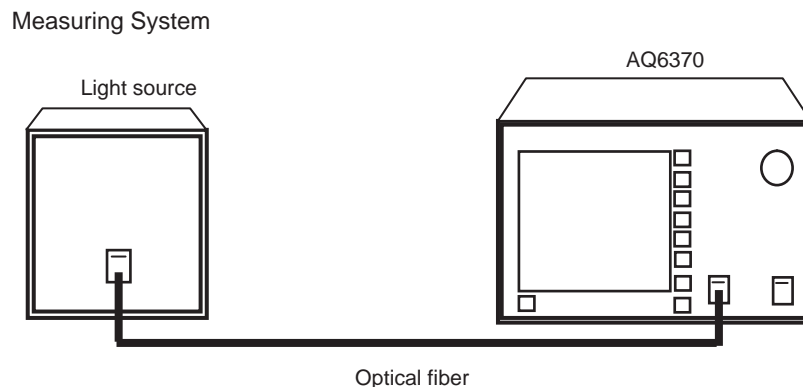

## 3.6 Alignment Adjustment

### Procedure

1. Turn the power to the instrument ON. Turn ON the **MAIN POWER** switch and press the **POWER** switch. For instructions on turning the power ON and OFF, see section 3.4.
2. Use a 9.5/125  $\mu\text{m}$  SM optical fiber to connect the instrument's optical input connector with the optical output connector.

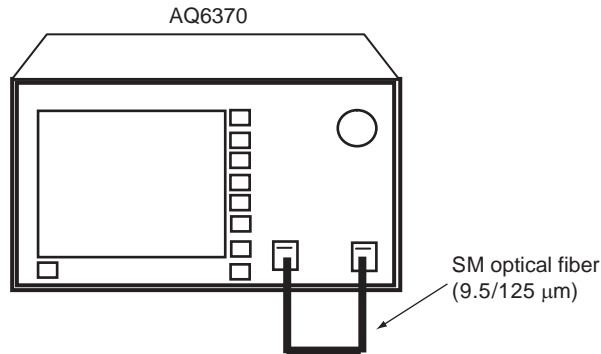

3. Press **SYSTEM**. The soft key menu is displayed.
4. Press the **OPTICAL ALIGNMENT** soft key.

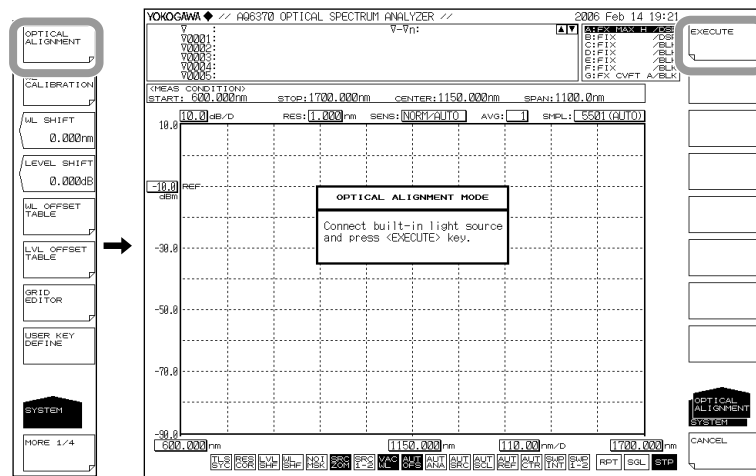

5. Press the **EXECUTE** soft key. Alignment adjustment is automatically executed. Adjustment finishes a few minutes thereafter, and you are returned to the original screen.
6. Press the **CANCEL** soft key to cancel alignment adjustment partway through the process.

### Note

- Always use the reference light source built in to the instrument for alignment adjustments. Alignment adjustments will be incorrect if an external light source is used.
- After alignment has been executed, wavelength calibration is also performed automatically inside the instrument.
- The alignment adjustment has no effect if the process is stopped. The instrument remains in the state prior to execution of the alignment adjustment.

**Explanation**

**Types of Optical Fibers**

The instrument can use single mode optical fibers with core diameters of 5 to 9.5 μm, and multimode (GI) optical fibers with core diameters of 50 and 62.5 μm. Functions may be limited or restricted depending on which type of optical fiber is used. The table below shows which of the typical types of fiber may be used and the limitations on their use.

**Limitations on Wavelength Resolution**

The maximum wavelength resolution for the instrument is 0.020 nm, which is only obtainable when using a single-mode optical fiber with a core diameter of 9.5 μm or less. As shown in Table, the maximum wavelength resolution decreases when optical fibers with thicker core diameters are used.

Setting a resolution value finer than those shown in the table below will simply result in an inaccurate measurement level without improving resolution.

Optical fibers with a thick core diameter are especially useful for inputting spatial light for measurement, but they have poor resolution.

Choose the best type of optical fiber for your particular application.

Note that the instrument is designed for input through optical fiber only. It will not work with inputs that do not pass through optical fiber, such as direct input of a gas laser beam to the optical input connector, or bonding an LED to the optical input connector. It is important to note that optical spectrum measurements taken through such inputs are completely unreliable.

For spatial light measurements, input the spatial light to the optical fiber and from the optical fiber to the instrument. A variety of adapters are available for this purpose.

**Summary of usable optical fiber types and usage limitations**

Optical Fiber Type		Obtained Wavelength Resolution (in nm)	Absolute Level Accuracy
Type	Core Diameter		
SM	5	0.020	NG
SM	9.5	0.020	OK
GI	50	0.050	NG
GI	62.5	0.050	NG
SI	50	0.050	NG
SI	80	0.100	NG
SI	100	0.200	NG
SI	200	0.500	NG
SI	400	1.000	NG
SI	800	2.000	NG

**Level Accuracy below the Cutoff Wavelength (Short Wavelength) of a Connected Optical Fiber**

With wavelengths at or below the cutoff level of the connected fiber, light propagates through the optical fiber in multiple modes. When high-coherent light from a light source such as a gas laser or DFB-LD light source propagates in multiple modes, speckle noise contained in the optical fiber output light may become unstable by the optical fiber's form, resulting in an inaccurate measurement level.

In such cases, improving the coupling between the light source and the optical fiber will lessen the level inaccuracy.

## 3.7 Wavelength Calibration

### Procedure

#### Wavelength Calibration Using the Internal Reference Light Source

1. Turn the power to the instrument ON.  
Turn ON the **MAIN POWER** switch and press the **POWER** switch.  
For instructions on turning the power ON and OFF, see section 3.4.
2. Use a 9.5/125  $\mu\text{m}$  SM optical fiber to connect the instrument's optical input connector with the optical output connector.
3. Press the **SYSTEM** key. The soft key menu is displayed.
4. Press the **WL CALIBRATION** soft key.

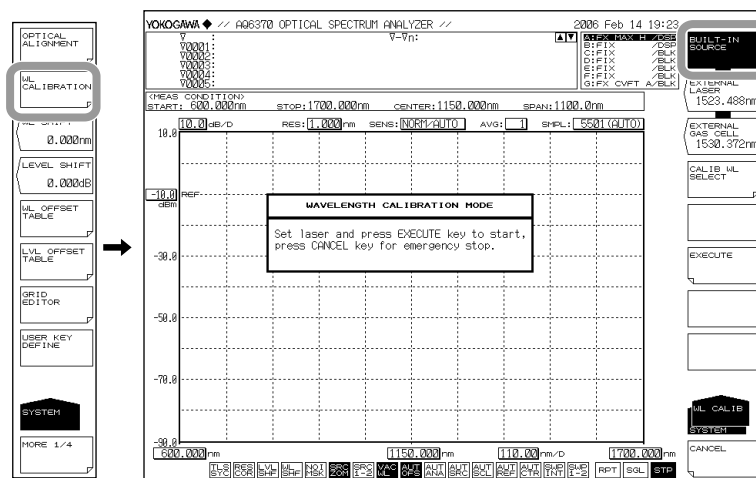

5. Press the **BUILT-IN SOURCE** soft key.
6. Press the **EXECUTE** soft key. Wavelength calibration is executed. The previous screen is displayed again after the calibration process ends.
7. Press the **CANCEL** soft key during wavelength calibration to cancel the wavelength calibration process.

### Note

- Always perform wavelength calibration after turning ON the power to the instrument and allowing the warm-up to finish.
- If you are using this instrument for the first time or using it after it has been severely shaken while being moved, you must perform the alignment adjustment procedure after warm-up ends.
- If the wavelength error of the instrument is outside of  $\pm 0.5$  nm, you cannot perform wavelength calibration with the internal reference light source.  
(Readjustment required. Contact your nearest Yokogawa representative.)

#### Wavelength Calibration Using and External Light Source

Instead of using the internal reference light source, it is also possible to calibrate the instrument using an external light source. However, the following light sources cannot be used for wavelength calibration.

- If the set wavelength is not the same as that of the calibration light source.
- If the wavelength error of the instrument is outside of  $\pm 0.5$  nm.  
(Readjustment required. Please contact your nearest Yokogawa representative.)
- If you are using a reference light source with multiple absorption lines, and the instrument's wavelength shift is greater than the wavelength interval of the absorption lines (with the result that an adjacent absorption line is used as the reference wavelength).

#### Connecting the External Light Source

1. Turn the power to the instrument ON.  
**Press the MAIN POWER** switch and press the **POWER** switch.  
For instructions on turning the power ON and OFF, see section 3.4.
2. Use a 9.5/125  $\mu\text{m}$  SM optical fiber to connect the external light source's optical output connector with the optical input connector.

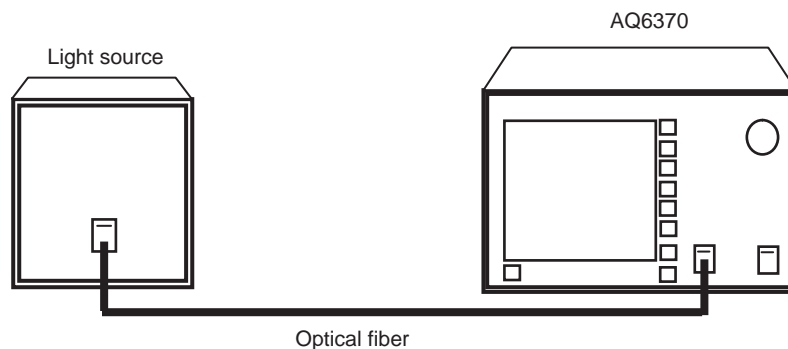

#### Setting the Type of External Light Source and Calibration Wavelength Value

3. Press **SYSTEM**. The soft key menu is displayed.
4. Press the **WL CALIBRATION** soft key.

Select the type of external light source (laser-type external light source or gas cell absorption line type external light source) and set the calibration wavelength value. There are three different ways to set the wavelength value.

**For Laser Type Light Sources**

5. Press the **EXECUTE LASER** soft key. A screen for specifying the wavelength of the external light source is displayed.
6. Select the laser wavelength value using the rotary knob or the arrow keys. The allowed wavelength range is 600–1700 nm.
7. Press **nm/ENTER**. The wavelength value is set.
8. Press the **EXECUTE** soft key. Wavelength calibration is executed. The previous screen is displayed again after the calibration process ends.
9. Press the **CANCEL** soft key during wavelength calibration to cancel the wavelength calibration process.

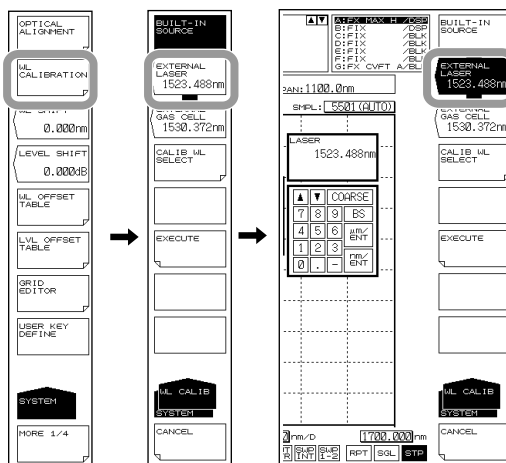

**For Gas Cell Absorption Line Type Light Sources**

5. Press the **EXECUTE GAS CELL** soft key. A screen for specifying the wavelength of the external light source is displayed.
6. Select the gas cell absorption line wavelength value using the rotary knob or the arrow keys. The allowed wavelength range is 600–1700 nm.
7. Press **nm/ENTER**. The wavelength value is set.
8. Press the **EXECUTE** soft key. Wavelength calibration is executed. The previous screen is displayed again after the calibration process ends.
9. Press the **CANCEL** soft key during wavelength calibration to cancel the wavelength calibration process.

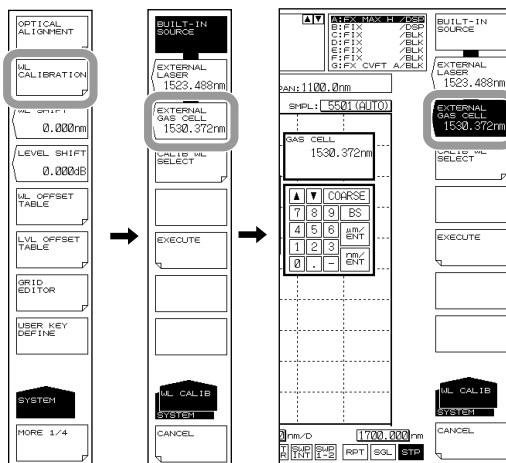

### 3.7 Wavelength Calibration

#### Using the Instrument's Internal Calibration Wavelength Value

6. Press the **CALIB WL SELECT** soft key. The soft key menu changes to show wavelength values.
7. Press the soft key corresponding to the appropriate wavelength value.
8. Press the **EXECUTE** soft key. Wavelength calibration is executed. The previous screen is displayed again after the calibration process ends.
9. Press the **CANCEL** soft key during wavelength calibration to cancel the wavelength calibration process.

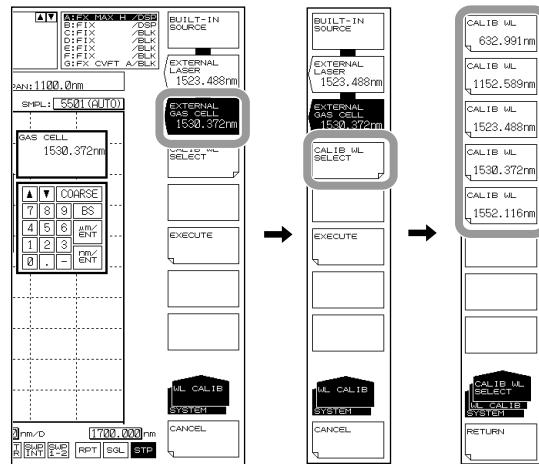

#### Note

It is not necessary to perform calibration on multiple wavelengths. If calibration is performed on multiple wavelengths, only the results from the final calibration are applied.

## Calibration Table

### Editing the User Calibration table. (Wavelength)

1. Press SYSTEM.
2. Press the WL OFFSET TABLE soft key. The wavelength calibration table appears along with a soft key menu for editing calibration values.
3. Press arrow soft keys to move the cursor to the wavelength to be edited, then press the WL EDIT soft key. A screen for entering numerical values is displayed.
4. Enter a value using the rotary knob, arrow keys, or numeric keypad.
5. Press ENTER.

**Note**

---

Normally, it is not necessary to use this function.

---

### Editing the User Calibration table. (Level)

1. Press SYSTEM.
2. Press the LVL OFFSET TABLE soft key. The level calibration table appears along with a soft key menu for editing calibration values.
3. Press arrow soft keys to move the cursor to the wavelength to be edited, then press the LEVEL EDIT soft key. A screen for entering numerical values is displayed.
4. Enter a value using the rotary knob, arrow keys, or numeric keypad.
5. Press ENTER.

**Note**

---

Normally, it is not necessary to use this function.

---

## 3.8 Important Points During Measurement

### Types of Optical Fibers

The instrument can use single mode optical fibers with core diameters of 5 to 9.5  $\mu\text{m}$ , and multimode (GI) optical fibers with core diameters of 50 and 62.5  $\mu\text{m}$ . Functions may be limited or restricted depending on which type of optical fiber is used. The table below shows which of the typical types of fiber may be used and the limitations on their use.

### Limitations on Wavelength Resolution

The maximum wavelength resolution for the instrument is 0.020 nm, which is only obtainable when using a single-mode optical fiber with a core diameter of 9.5  $\mu\text{m}$  or less. As shown in Table, the maximum wavelength resolution decreases when optical fibers with thicker core diameters are used.

Setting a resolution value finer than those shown in the table below will simply result in an inaccurate measurement level without improving resolution.

Optical fibers with a thick core diameter are especially useful for inputting spatial light for measurement, but they have poor resolution.

Choose the best type of optical fiber for your particular application.

Note that the instrument is designed for input through optical fiber only. It will not work with inputs that do not pass through optical fiber, such as direct input of a gas laser beam to the optical input connector, or bonding an LED to the optical input connector. It is important to note that optical spectrum measurements taken through such inputs are completely unreliable.

For spatial light measurements, input the spatial light to the optical fiber and from the optical fiber to the instrument. A variety of adapters are available for this purpose.

### Summary of usable optical fiber types and usage limitations

Optical Fiber Type		Obtained Wavelength Resolution (in nm)	Absolute Level Accuracy
Type	Core Diameter		
SM	5	0.020	NG
SM	9.5	0.020	OK
GI	50	0.050	NG
GI	62.5	0.050	NG
SI	50	0.050	NG
SI	80	0.100	NG
SI	100	0.200	NG
SI	200	0.500	NG
SI	400	1.000	NG
SI	800	2.000	NG

### Input Optical Fiber Numerical Aperture (NA) and Level Measurement Values

The level measurement error of the instrument changes as shown in the figure below, according to the numerical aperture (NA) of the optical fiber connected to the input connector. The instrument's absolute level is calibrated using a 9.5/125  $\mu\text{m}$  single-mode optical fiber (SSMA type in JIS C6835, with PC polishing, 9.5  $\mu\text{m}$  mode field diameter, and 0.104 to 0.107 NA). Even if a single-mode optical fiber is used, the level accuracy will be outside the specifications if the NA is not in the range shown above.

Input optical fiber numerical aperture and level error (typical characteristics)

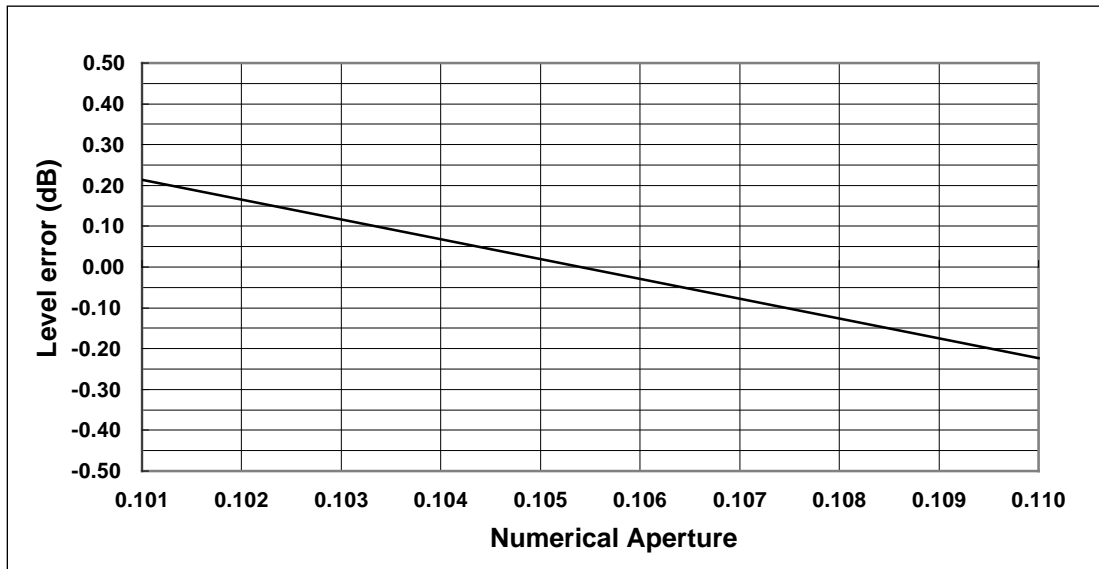

### Absolute Level Accuracy

The instrument's absolute level is calibrated with a 9.5  $\mu\text{m}$  single-mode optical fiber. In terms of actual capability, even single-mode optical fibers that do not have a core diameter of 9.5  $\mu\text{m}$  provide nearly the same level of accuracy.

Multimode (GI) fiber provides a relatively accurate spectrum if the light source is low-coherent light such as white light, natural light, or an LED. If the light source has high coherency as in the case of a laser beam, interference will occur inside the optical fiber, and the intensity distribution of light radiating from the fiber tip will vary according to the fiber form. As a result, the spectrum (measurement level) may fluctuate if the fiber is moved.

When an optical fiber with a large core diameter or large NA value is used, a low fraction of the light emitted from the optical fiber is received. Therefore, the measurement level is lower than the true value, but the optical spectrum is accurate in relative terms.

### Level Accuracy below the Cutoff Wavelength (Short Wavelength) of a Connected Optical Fiber

With wavelengths at or below the cutoff level of the connected fiber, light propagates through the optical fiber in multiple modes. When high-coherent light from a light source such as a gas laser or DFB-LD light source propagates in multiple modes, speckle noise contained in the optical fiber output light may become unstable by the optical fiber's form, resulting in an inaccurate measurement level.

In such cases, improving the coupling between the light source and the optical fiber will lessen the level inaccuracy.

### Measurement Sensitivity and Vertical Axis Effective Range

When the measurement sensitivity is set to NORMAL HOLD, the internal amplifier has a fixed gain. Five different gains are set automatically according to the reference (REF) level setting. However, the effective range of measurement data is limited to the following range, using the reference (REF) level (dBm) as a reference.

$$\text{REF}-20 \text{ dBm} < (\text{effective range}) < \text{REF}+10 \text{ dBm}$$

If the level scale is set to 10 dB/DIV, the display would exceed the effective range, so the areas at 10 dB from the screen stop and 20 dB from the bottom are inaccurate.

When measurement sensitivity is set to NORMAL HOLD, we recommend setting the level scale to 5 dB/DIV or less.

Under the measurement sensitivity settings NORMAL AUTO, MID, and HIGH 1–3, an automatic gain is used, permitting measurements over a wide level range through a single sweep. Select the appropriate sensitivity level based on the light reception level required for the particular measurement application.

### Stray Light from the Monochromator

The instrument has a newly designed, high-performance monochromator. Depending on the measurement conditions, stray light at a level 30 to 50 dB below the original spectrum, as well as other stray light specific to the monochromator may occur in wavelength areas 100 to 200 nm from the peak wavelength. If this stray light is likely to have a severe impact on measurements, the sensitivity can be set to HIGH 1–3 and CHOP MODE can be set to CHOP or SWITCH in order to reduce the effects of the stray light.

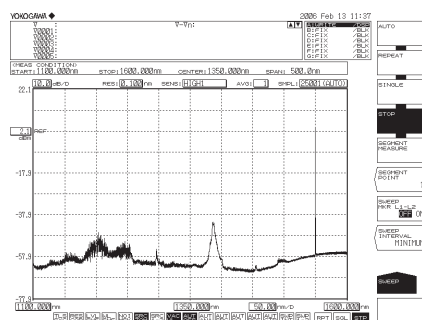

Waveform with CHOP MODE OFF

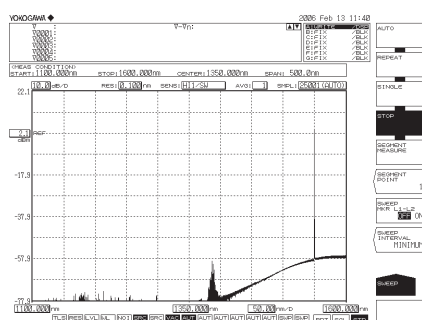

CHOP MODE set to SWITCH

### CHOP MODE Function List

CHOP MODE	Function	Merit	Defect
OFF	Measurement according to the stray light. Stray light suppression ratio: 40 dB or more	Measurement time is rapid even for high sensitivity measurements.	Since the stray light is also measured, the low level component is not accurate if the light source is of high power.
CHOP	High dynamic measurement using internal modulation. Stray light suppression ratio: 60 dB or more	Measurement can be taken with stray light removed. Long-duration, high sensitivity measurements possible since offset does not change.	Measurement time is long.
SWITCH	Two sweeps per measurement are performed. The first sweep measures the stray light component, and high dynamic measurement is possible through subtraction. Stray light suppression ratio: 60 dB or more	Short-duration measurement can be taken with stray light removed.	If the measurement duration is long, it is influenced by temporal changes in the measured light.

### Ripples in the 1350–1450 nm Area

Water (OH-) ions present in the monochromator absorb light in the 1350–1450 nm area, resulting in ripples in the measurement waveform. Either set a coarser resolution or use the monochromator in a lower-humidity environment to reduce the amount of ripples.

### Waveforms with Resolutions of 0.020 nm

When the resolution is set to 0.020 nm for measurements of a light source such as a DFB laser in which with the spectral width is narrower than the instrument's resolution, very small spikes may occur at the skirts of the waveform. This type of spike occurs due to characteristics of the optical block and is not an indication of any problem. Even if such spikes occur, satisfactory performance in terms of resolution, dynamic range, and the like can be ensured. These spikes will disappear if the resolution is set to a coarser value.

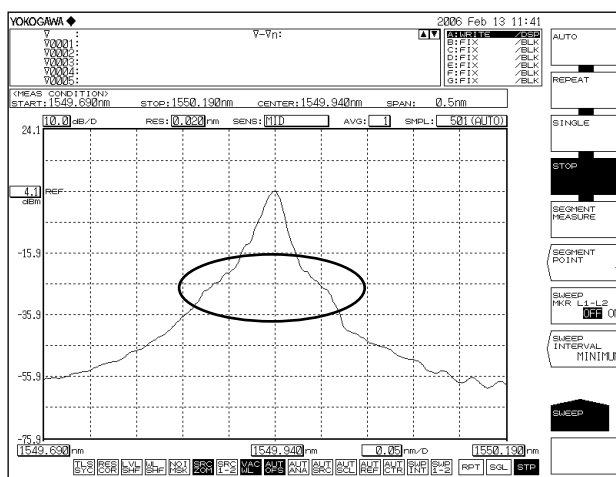

### Second-Order Diffracted Light

The monochromator in this instrument uses a diffraction grating, and when light in a certain wavelength range is input, a “grating ghost” of second-order diffracted light appears.

Therefore, it is important to understand this distinctive characteristic in order to correctly analyze the measured results from the instrument.

The graph below shows the correlation between the wavelength displayed on screen and the actual wavelength.

The displayed wavelength is on the horizontal axis, with the true wavelength on the vertical axis. The solid lines in the graph indicate correspondences between displayed and actual wavelengths. The thick solid line is the correlation with the correct light spectrum (of course, the displayed wavelength and actual wavelength match), and the thin solid line shows the correlation with the ghost spectrum of the second-order diffracted light.

For example, if 633 nm light is input, a horizontal line is drawn at 633 nm on the vertical axis, and the point of intersection on the graph of the line is the displayed wavelength. From this, you can see that besides 633 nm, a grating ghost appears at 1266 nm.

### 3.8 Important Points During Measurement

Relationship between the Wavelength Displayed on Screen and the Actual Wavelength

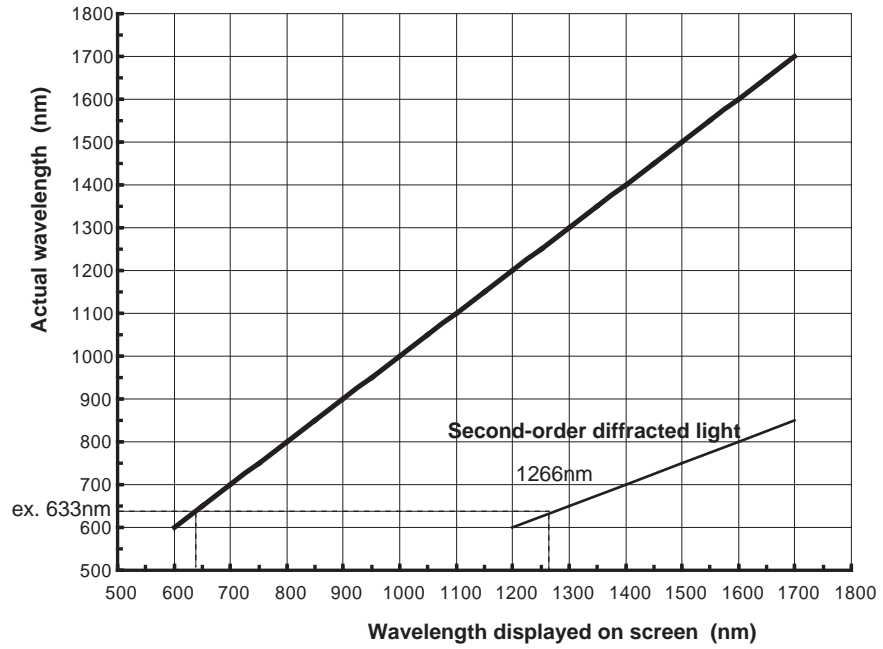

Example of measurement in which second-order diffracted light appears at 1266 nm

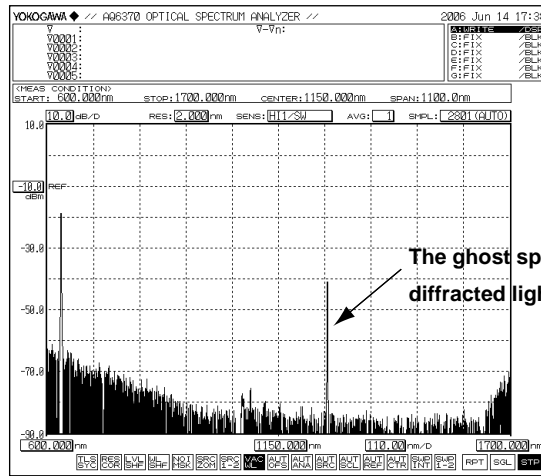

## 4.1 Description of Soft Keys

When you press a function key, the soft key menu (inside the screen) located on the right side of the screen changes.

The soft key menus are designed to provide a certain level intuitiveness, with the individual soft keys having particular forms which make them easy to understand.

### Forms and Behavior



This is a normal soft key.  
Press to execute its function immediately.



Contains a submenu.  
Indicates that there is a submenu of additional items related to the current item.  
Press to display the submenu.



A separate window will be displayed.  
Press to display a separate window in the screen for entry of numerical parameters.  
A submenu and separate window will be displayed.



Press to move to the submenu and display a separate window.  
This softkey returns to the previous menu.

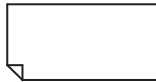

Press to display the previous soft key menu.  
This is a selection soft key.

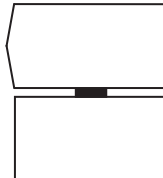

Select one of the soft keys connected with the black band.  
When selected, the soft key is displayed in reverse video.  
Several soft keys can be connected.

Display Examples

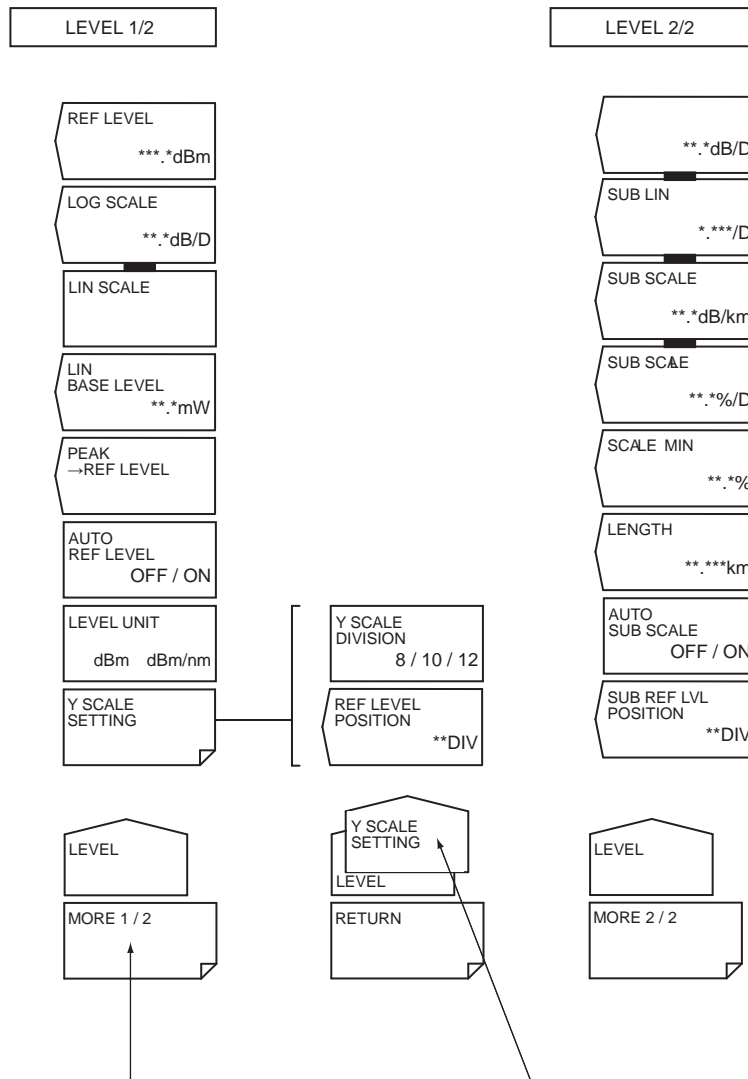

The LEVEL soft key menu is split into two parts. This key switches between the menus. In addition, in some cases this may change to a function that closes the window. For example, when the MORE 1/2 soft key is pressed, the menu changes to the LEVEL 2/2 soft key menu, and the key display changes to MORE 2/2.

Shows the submenu of the soft key menu. In this example, the soft key menu is within the Y SCALE SETTING submenu (for display only, no keys are available).

## 4.2 Using the Mouse and External Keyboard

### Using the Mouse

With a connected mouse you can perform the same operations as with the instrument's panel keys. Also, if you move the mouse pointer over the item in the menu screen that you wish to select and click it, the instrument responds exactly as if you had pressed the corresponding soft key. The USB mouse is connected to the USB interface on the front panel of the instrument.

For instructions on connecting the mouse, see section 3.3.

### Operations the Same as the Panel Keys

#### Displaying the Top Menu

Right-click the mouse in the screen. The names of the front panel keys in the instrument's FUNCTION section are displayed.

CENTER SPAN LEVEL
SWEEP ZOOM
SETUP TRACE DISPLAY
MARKER PEAK SEARCH ANALYSIS
USER MEMORY FILE PROGRAM ADVANCE SYSTEM
UNDO/LOCAL COPY FEED HELP

#### Selecting Items

Move the pointer to the item you wish to select and click. A setting menu for the selected item appears. The list of front panel key names disappears.

#### Clearing the List of Front Panel Keys

Move the pointer away from the list of front panel keys and click.

### Operations the Same as the Soft Keys

#### Selecting Functions from the Soft Key Menu

Move the pointer to the soft key you wish to select and click. A screen corresponding to the action of the soft key appears.

### Using the External Keyboard

The functions of each of the front panel keys of the instrument are assigned to keyboard keys, allowing you to manipulate them with a keyboard just as you would by using the instrument's panel keys.

The panel key correspondence table below shows the correspondences between the panel keys and the keys on the keyboard. Also, you can directly enter labels, file names, and numbers.

**Panel Key Correspondence Table**

Type	Function	External Keyboard	Description	
FUNCTION	Sweep	SWEEP	[SHIFT]+[F1]	Executes/sets sweep
	Meas. settings	CENTER	[SHIFT]+[F2]	Sets measurement center wavelength
		SPAN	[SHIFT]+[F3]	Sets measurement span
		LEVEL	[SHIFT]+[F4]	Sets level axis
		SETUP	[SHIFT]+[F5]	Sets resolution, sensitivity, etc.
	Display settings	TRACE	[SHIFT]+[F6]	Sets trace
		ZOOM	[SHIFT]+[F7]	Sets display scale
		DISPLAY	[SHIFT]+[F8]	Sets screen display
	Analysis functions	MARKER	[SHIFT]+[F9]	Sets marker
		SEARCH	[SHIFT]+[F10]	PEAK/BOTTOM search function
		ANALYSIS	[SHIFT]+[F11]	Sets analysis function
	Other	USER	[ALT]+[F1]	User settings menu
		MEMORY	[ALT]+[F2]	Memory
		FILE	[ALT]+[F3]	Saves/opens files, file actions
		PROGRAM	[ALT]+[F4]	Program Functions
ADVANCE		[ALT]+[F5]	Advanced functions	
SYSTEM		[ALT]+[F6]	System settings	
Soft keys	F1 to F9	F1 to F9	Depends on FUNCTION menu	
Auxiliary keys	UNDO/LOCAL	[ALT]+[F9]	Local: UNDO function Remote: Returns to the local state.	
	COPY	[ALT]+[F10]	Screen copy	
	FEED	[ALT]+[F11]	Feeds internal printer paper	
	HELP	[ALT]+[F12]	Displays Help (use UNDO/LOCAL to exit Help)	
DATA ENTRY	Numeric keypad	0123456789.-	Numeric value input	
	BACK SPACE	Back Space	Deletes one character from input value	
	um/ENTER	None	Confirms entry	
	nm/ENTER	ENTER	Confirms entry	
	Rotary knob	[→],[←]	Changes numeric values/items	
	Arrow keys ([UP],[DOWN])	[↑],[↓]	Numeric value one-step change, item change, table scrolling	
COARSE	[ALT]+[N]	Switches between fine and coarse encoder		

## 4.3 Entering Numerical Values and Strings

### Entering Numerical Values

You can use the numeric keypad, rotary knob, or arrow keys in the DATA ENTRY section.

1. Press the soft key of a parameter. The currently set value is shown in the parameter input window.

### Direct Entry Using the Numeric Keypad

2. Press a numeric keypad key. The numeric keypad input area appears, and the number of the pressed key is displayed.
3. After entering a numerical value, press the  $\mu\text{m}/\text{ENTER}$  or  $\text{nm}/\text{ENTER}$  key depending on the unit of the input parameter. The value in the numeric keypad input area appears in the parameter input window, and is set internally. If a parameter does not have a unit associated with it, you can use either the  $\mu\text{m}/\text{ENTER}$  or  $\text{nm}/\text{ENTER}$  key.

If you make an error when inputting values with the numeric keypad:

4. Press **BACK SPACE**. The last (right-most) entered character in the numeric keypad input area is removed, allowing entry of the correct character.

### Note

- If the value entered with the numeric keypad is not in the allowed value range, the nearest allowed value will be set.
- By holding the BACK SPACE key down, you can erase the entire entry in the numeric keypad input area and make the numeric keypad input area disappear, returning to the condition preceding numeric keypad input.

### Entry Using the Rotary Knob and Arrow Keys

2. Continuing on from step 1, turn the rotary knob, or press an arrow key. The currently set value is changed.
3. When you press the **COARSE** key the digit of the setting to be changed rises, or the numeric value increase/decrease step increases. Press the **COARSE** key again to restore the previous digit/step.

When COARSE is selected, the COARSE key lights.

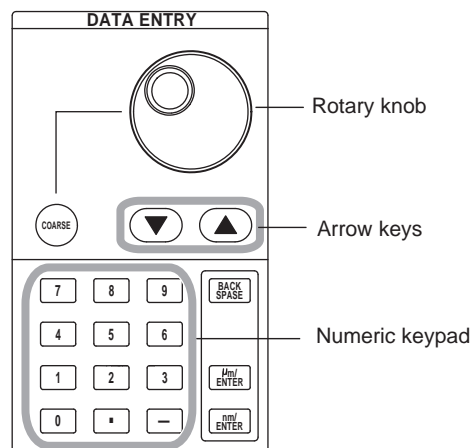

## Entering Strings

Character strings can be entered from the character selection area displayed on screen using the rotary knob and soft keys.

### Entry Procedure

The following is an example of entering a label.

1. Press **DISPLAY**. The soft key menu for the screen display appears.
2. Press the **LABEL** soft key. The text selection area and label entry area are displayed.

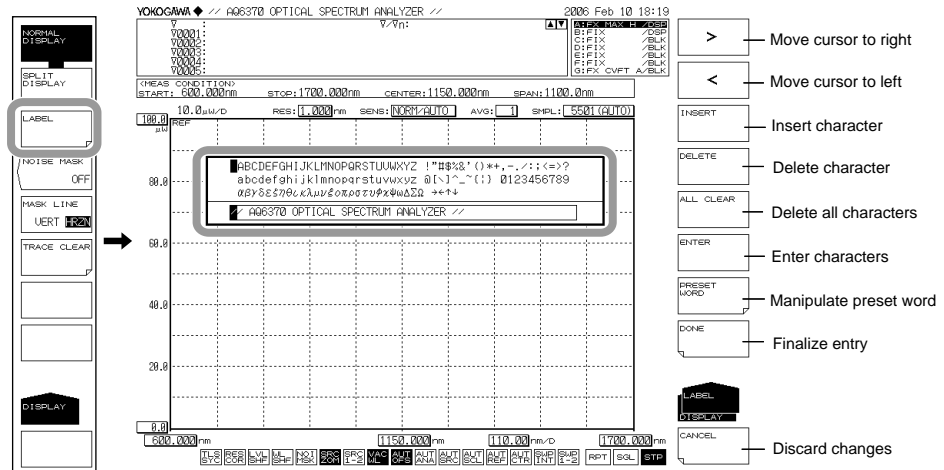

3. Move the rotary knob to the character in the character selection area that you wish to enter. Use the rotary knob or arrow keys to move the cursor in the character selection area.
4. Press the **ENTER** soft key. The character selected at the cursor position in the label input area is displayed.
5. To move the cursor, or insert or delete a character in the label input area, press the corresponding soft key.
6. When the character string is entered, press the **DONE** soft key. The input character string is entered.

### Note

- In addition to when pressing **DISPLAY**, the character input screen appears whenever a string must be entered on the instrument, such as when entering a file name for saving a file.
- Numerical input can be performed directly from the numeric key pad.

## 4.4 Screen Display

### Procedure

1. Press **SYSTEM**. The soft key menu is displayed.
2. Press the **MORE 1/4** soft key two times. The soft key menu switches to the **MORE 3/4** screen.

### Setting the Number of Displayed Digits for Level Data

3. Press the **LEVEL DISP DIGIT** soft key. The digit setting menu is displayed.
4. Press the soft key corresponding to the desired number of digits.
  - 1DIGIT** Sets the number of level data display digits (below the decimal point) to 1 digit.
  - 2DIGIT** Sets the number of level data display digits (below the decimal point) to 2 digits.
  - 3DIGIT** Sets the number of level data display digits (below the decimal point) to 3 digits.

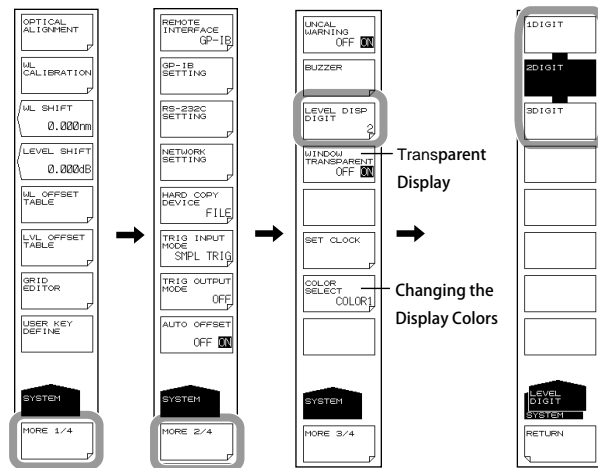

### Transparent Display

3. Continuing on from step 2, press the **WINDOW TRANSPARENT OFF ON** soft key. Transparent display turns ON or OFF. When ON, the parameter input window and overview display window are displayed transparently.

### Changing the Display Colors

3. Continuing on from step 2, press the **COLOR SELECT** soft key. The display color setting menu is displayed.
4. Press the soft key corresponding to the desired display color.
  - COLOR1** Sets the screen display color to "COLOR 1".
  - COLOR2** Sets the screen display color to "COLOR 2".
  - COLOR3** Sets the screen display color to "COLOR 3".
  - COLOR4** Sets the screen display color to "COLOR 4".
  - COLOR5** Sets the screen display color to "COLOR 5".
  - B&W** Sets the screen display color to black-and-white.

## 4.5 Setting the Date and Time

The AQ6370 displays the date and time in the upper right corner of the screen. This information is used when outputting to a printer, or for a time stamp when recording data.

### Displaying the Date and Time Dialog Box

1. Press **SYSTEM**. The soft key menu is displayed.
2. Press the **MORE** soft key two times. The soft key menu switches to the MORE 3/4 screen.
3. Press the **SET CLOCK** soft key. The internal clock setting screen is displayed.

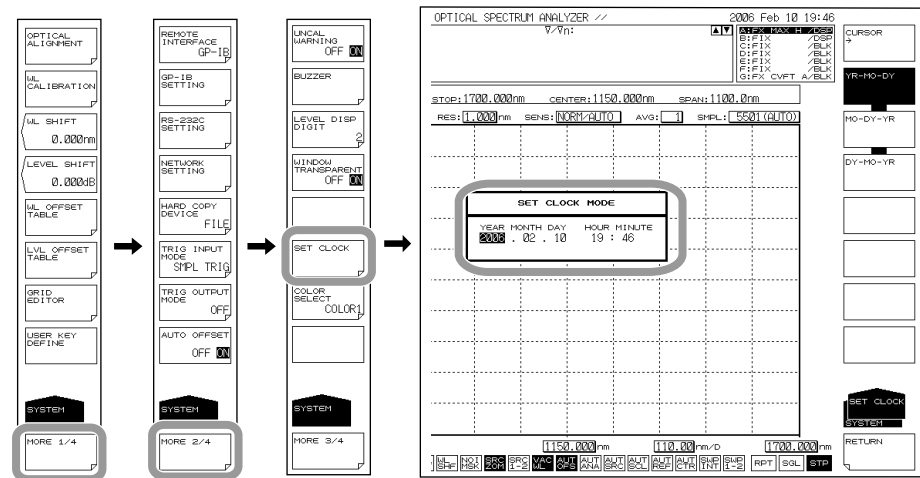

### Entering the Date and Time

4. Press the **CURSOR ->** soft key, then move the cursor to the item you wish to input. The cursor moves each time you press the soft key.
5. Press a numeric key button to enter a number.
6. Press **ENTER**. The input number is entered.

### Changing the Display Format

7. Press the **MO-DY-YR** soft key.  
The date is displayed in the order Month, Day, Year.  
**Press the DY-MO-YR** soft key.  
The date is displayed in the order Day, Month, Year.  
**Press the YR-MO-DY** soft key.  
The date is displayed in the order Year, Month, Day.

### Concluding the Settings

8. Press the **RETURN** soft key. The settings are concluded, and the screen returns to the previous stage.

## 4.6 Printing Out Using the Internal Printer (Optional)

### Printer Roll Paper

The printer uses proprietary roll paper. Do not use any other kind of paper. When using the printer for the first time, use the paper included. When the roll paper runs out, order refills from you nearest Yokogawa branch, dealer, or sales office.

Part Number	B9988AE
Specifications	Thermal sensible paper, 10 m
Lot qty.	10 rolls

### Handling the Roll Paper

This roll paper is thermal-sensible roll paper that changes color through a thermochemical reaction. Therefore, please note the following.

#### Storage Precautions

Thermal-sensible paper that is being used starts to change color gradually at 70°C. Since it is affected by heat, humidity, light, chemicals, and other factors even when unused or finished being used, the following precautions must be taken.

- Store the paper in a dry, cool place.
- Use the paper as quickly as possible after opening the package.
- If plastic film containing plasticizers (such as vinyl chloride film or cellophane tape) are allowed to come into contact with the paper for long periods of time, recorded items can fade. For example, if storing the printouts in a binder, use one made of polypropylene.
- If using adhesive on the paper, do not use an adhesive containing alcohol, ethyl, or other organic compounds. Discoloration can result.
- When storing printouts for long periods of time, it is recommended to make photocopies. Due to the properties of thermal-sensible paper, recorded portions on the paper can fade.

#### Usage Precautions

- Always use the proprietary roll paper supplied by Yokogawa.
- If handled with sweaty hands, fingerprints can appear, or recorded information can be smeared.
- If you rub the surface with a hard object, heat from the friction can cause marks to appear.
- If chemicals, oil, or other substances contact the paper, discoloration or erasure of recorded information can occur.

## Installing Roll Paper

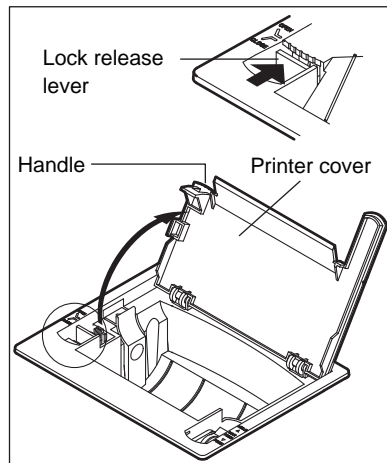

Open the printer cover by lifting it up by the handle on the left side while pressing the lock release lever in the OPEN direction.

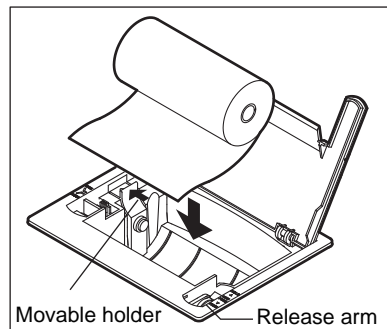

Move the release arm in the right-front to the MAN FEED position. Orient the roll paper so that the inner side (not the shiny side) faces up. Pushing the movable holder on the left side of the roll paper bin to the left, place the roll into the bin right-side-first, then release the movable holder.

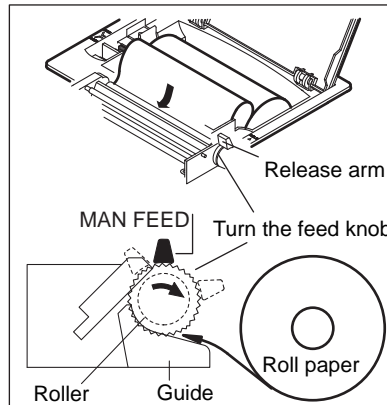

Insert the edge of the roll paper evenly between the roller and black-colored guide, then turn the paper feed knob until the edge of the roll paper protrudes about 10 cm from the top of the roller.

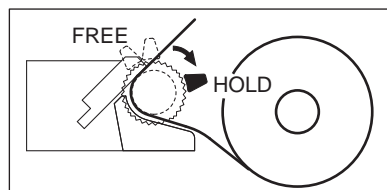

Move the release arm to the FREE position, adjust the slack of the roll paper, then move the release arm to the HOLD position. If the arm is left in the FREE or MAN FEED position, a printer error will occur, and printing will be disabled.

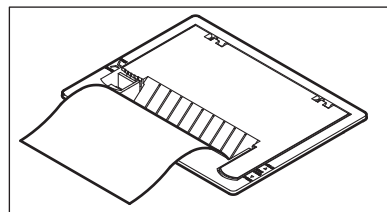

Fold the printer cover down toward you to close it. As you close the cover, feed the paper through the paper ejection hole in the cover. Close the cover firmly until you hear a click.

### **Note**

The paper feed can be unstable immediately after the roll paper has been installed. Print out 2 or 3 screen shots before beginning normal use.

## Printing

You can output the measured waveforms displayed on screen to the internal printer.

### Executing Printing

1. Press **COPY**. An image of the current screen is printed on the built-in printer.

### Cancelling Printing

2. Press **UNDO/LOCAL**.

### Feeding Paper

3. Press **FEED**. Paper feeding continues as long as you hold down the button.

#### **Note**

- If you press COPY during sweeping, sweeping stops. After printing, sweeping starts again.
- If the printer runs out of recording paper during printing or if you press COPY without returning the release arm to the HOLD position, the following warning is displayed: (WARNING 160 : "Printer paper empty", WARNING 161 : "Printer head up").
- When printing continuously for a long period of time, the printer head can become hot, causing printer failure. The following warning is displayed: (WARNING 164: "Printer Head Temperature error"). If this warning appears, wait a few minutes and try again. When the printer head cools down, the printing capability will be restored. Avoid printing continuously for long periods of time.

# 5.1 Auto Measurement

## Procedure

This key automatically sets the optimal measurement conditions for the light source being measured, and performs measurement.

1. Press **SWEEP**. The soft key menu regarding sweeping appears.
2. Press the **AUTO** soft key. The soft key display reverses, and auto measurement executes.

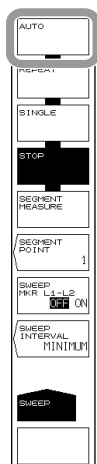

Waveform display example

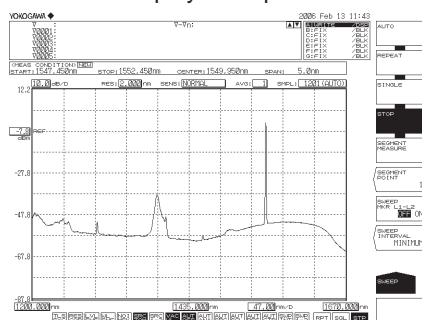

Screen after auto sweep start value

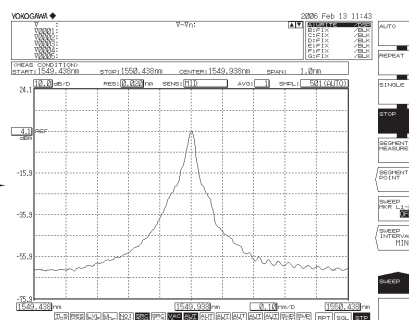

Screen after auto sweep stop

## Explanation

The wavelength range of input light that can be auto-measured is 1200–1670 nm.

The following four items are set automatically, after which measurement is performed.

- Center wavelength (CENTER)
- Sweep width (SPAN)
- Reference level (REF LEVEL)
- Resolution (RESOLUTION)

After performing one auto sweep and setting optimal measurement conditions, a repeat sweep is made for measurement.

During the automatic setting, only the following keys are enabled: REPEAT, SINGLE, STOP, and UNDO/LOCAL (when under remote control).

## 5.2 Horizontal/Vertical Axis Settings

### Procedure

#### Setting Up the Horizontal Axis

The units of the horizontal axis can be set to wavelength or frequency.

1. Press **SETUP**. The soft key menu for sweep condition settings appears.
2. Press the **HORIZON SCAL nm/THz** soft key. The units for the horizontal axis switch from THz to nm, or viceversa.

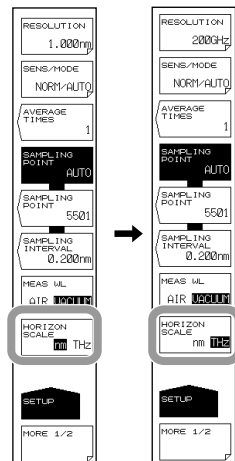

### Note

Pressing the HORIZON SCALE nm/THz soft key repeatedly toggles between nm and THz.

#### Setting the Measured Wavelength to Air Wavelength or Vacuum Wavelength

1. Press **SETUP**. The soft key menu for sweep condition settings appears.
2. Press the **MEAS WL AIR VACUUM** soft key. The measured wavelength is changed to either a vacuum wavelength or an air wavelength.

### NOTE

- This function only applies to measurements taken after the setting is selected. Previously measured waveforms are not affected.
- If vacuum wavelength is set, **VAC WL** is displayed at the very bottom of the screen in inverse video.

## Setting Up the Vertical Axis

### Setting to Log Scale Display

1. Press LEVEL. The soft key menu for vertical axis settings appears along with the reference level setting screen.
2. Press the LOG SCALE soft key. The vertical axis is displayed with the currently specified log scale values. At the same time, the log scale value setting screen is displayed.
3. Enter a log scale value using the rotary knob, arrow keys, or numeric key pad.
4. Press ENTER.

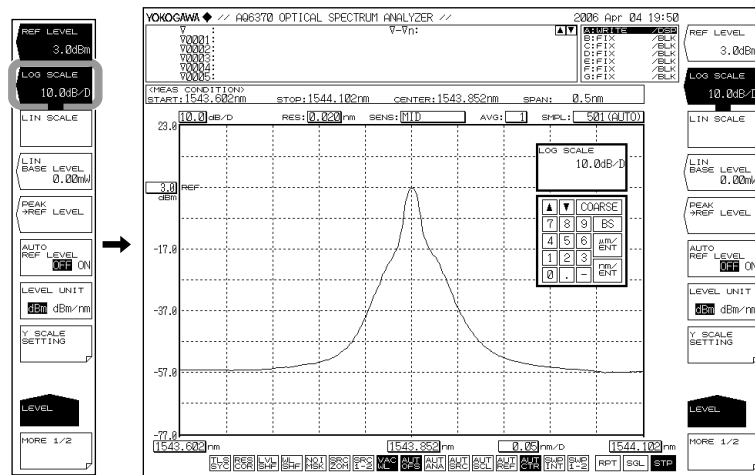

### Setting to Linear Scale Display

1. Press LEVEL. The soft key menu for vertical axis settings appears along with the reference level setting screen.
2. Press the LIN SCALE soft key. The vertical axis is displayed with the currently specified linear scale values.
3. Press the LIN BASE LEVEL soft key. A screen for setting the lower-end value of the level scale is displayed.
4. Enter a value using the rotary knob, arrow keys, or numeric key pad.
5. Press ENTER.

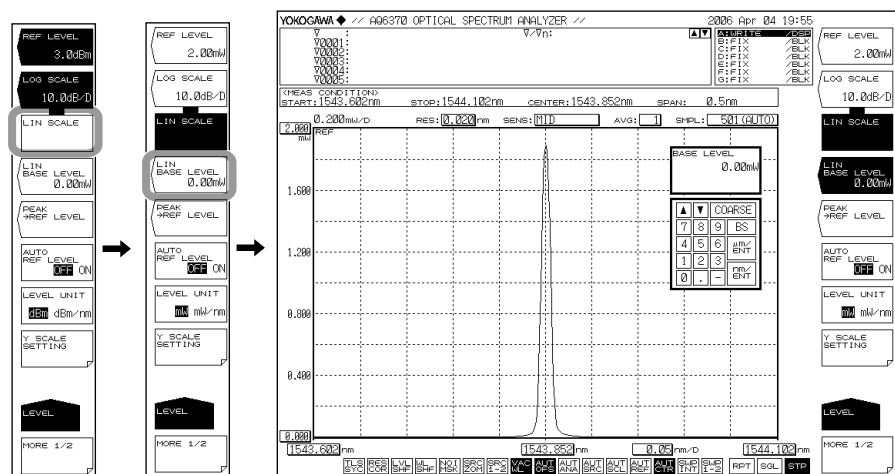

### Setting Units for the Vertical Axis

1. Press LEVEL.
2. Press the LEVEL UNIT soft key. When the vertical axis is log scale, the instruments toggle between dBm and dBm/nm each time you press the key. With a linear scale, it scrolls through nW,  $\mu$ W, mW, or pW, and nW/nm,  $\mu$ W/nm, mW/nm or pW/nm.

### Setting the Number of Vertical Axis Divisions (for LOG SCALE)

1. Press LEVEL.
2. Press the LOG SCALE soft key.
3. Press the Y SCALE SETTING soft key. The level scale setting menu is displayed.
4. Press the Y SCALE DIVISION soft key. The soft key menu for selecting a number of divisions is displayed.
5. Press a soft key corresponding to 8, 10, or 12 divisions. The level axis is displayed with divisions as selected.

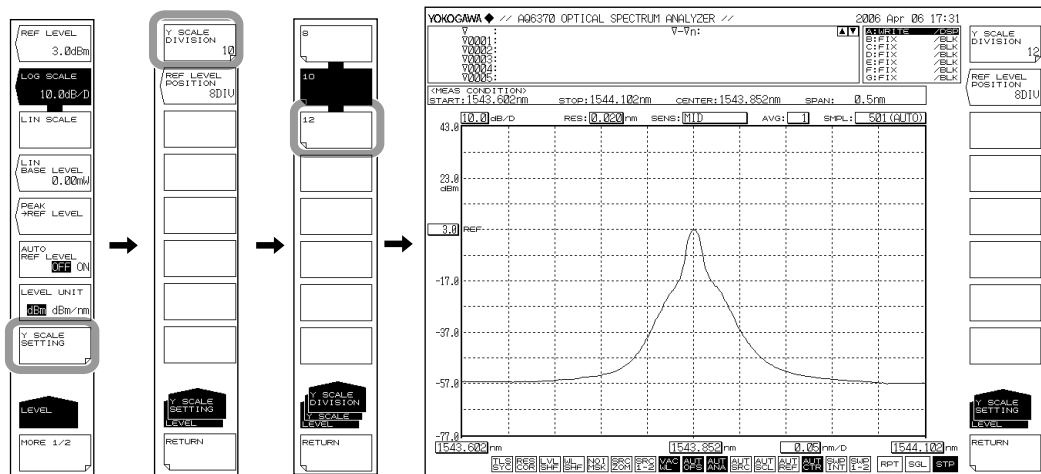

**Note**

- This is only available when the main scale is a log scale.
- When it is a linear scale, the number of divisions is fixed at 10.

### Reference Level Screen Position Setting (for LOG SCALE)

4. Continuing on from step 3, press the REF LEVEL POSITION soft key. A screen for setting the screen position of the reference level (REF position) is displayed.
5. Enter a value starting from the bottom of the screen using the rotary knob, arrow keys, or numeric key pad. The setting range is 0 to 12. The setting resolution is steps of 1, or steps of 1-2-5 when COARSE is pressed.
6. Press ENTER.

**Note**

- This is only available when the main scale is a log scale.
- If the REF position value is larger than the number of divisions, it is forcibly reduced to the number of divisions.
- When using linear scale, the REF position is at the top (fixed to 10 divisions).

**Explanation****Wavelength Display Mode**

- Displays the measured waveform with the wavelength on the X axis.
- The measurement scale and display scale are set based on the wavelength.
- The X axis unit for marker values and analysis function results is wavelength.

**Frequency Display Mode**

- Displays the measured waveform with the frequency on the X axis.
- The measurement scale and display scale are set based on the frequency.
- The X axis unit for marker values and analysis function results is frequency.

**Display Units of the X-Axis and Marker Values**

The display unit for the marker value (wavelength or frequency) can be set independently of the waveform display's horizontal axis units (wavelength or frequency) that were specified using the HORIZON SCALE nm/THz soft key under SETUP. (Default: nm) (This key can be used to enter settings such as frequency display mode on the X axis and wavelength display mode for the marker value.)

Also, the MARKER UNIT nm THz soft key's setting changes in conjunction with the setting of the HORIZON SCALE soft key. However, changing the MARKER UNIT nm THz soft key's setting does not change the setting for the HORIZON SCALE nm/THz soft key.

**Note**

The MARKER UNIT nm THz soft key's setting changes in conjunction with the setting of the HORIZON SCALE soft key. However, changing the MARKER UNIT nm THz soft key's setting does not change the setting for the HORIZON SCALE nm/THz soft key.

**LOG SCALE \*\*. \*dB/D**

This key switches the vertical axis to LOG display and sets the level scale.

The setting range is 0.1 to 10.0 dB/DIV. Settings can be adjusted in steps of 0.1 dB. If you press the COARSE key you can change the numerical value in 1-2-5 steps, for example: 1dB/DIV -> 2dB/DIV -> 5dB/DIV.

When the setting is changed, the displayed waveform is redrawn according to the changed scale.

If the value is set to a scale larger than 5 dB/DIV in range fixing mode (SENS:NORMAL/HOLD) or pulse light measurement mode, the waveform will not be correctly measured in the vertical direction so a warning is displayed.

**Measurement Sensitivity and Vertical Axis Effective Range**

When the measurement sensitivity is set to NORMAL HOLD, the internal amplifier has a fixed gain. Five different gains are set automatically according to the reference (REF) level setting. However, the effective range of measurement data is limited to the following range, using the reference (REF) level (dBm) as a reference.

REF-20 dBm < (effective range) < REF+10 dBm

If the level scale is set to 10 dB/DIV, the display would exceed the effective range, so the areas at 10 dB from the screen stop and 20 dB from the bottom are inaccurate.

When measurement sensitivity is set to NORMAL HOLD, we recommend setting the level scale to 5 dB/DIV or less.

Under the measurement sensitivity settings NORMAL AUTO, MID, and HIGH 1-3, an automatic gain is used, permitting measurements over a wide level range through a single sweep. Select the appropriate sensitivity level based on the light reception level required for the particular measurement application.

## 5.2 Horizontal/Vertical Axis Settings

---

### **LIN SCALE**

This key is used to set the main scale to linear scale.  
Settings per 1 DIV are set in the reference level.

### **LIN BASE LEVEL \*\*. \*mW**

Value when the vertical axis is linear scale, you can set the level scale low-end. This is not available when using a log scale.

The setting range is 0.0 to REF level x 0.9. Settings can be adjusted in steps of 0.1. The value changes in steps of 1 if you press the COARSE key. Values can only be set in the instrument set for the REF level.

When the setting is changed, the displayed waveform is redrawn according to the changed scale.

The scale display in the upper left part of the waveform is 1/10 the value (\*W/D) of the reference (REF) level minus the low-end (BASE) level.

For information on the REF level setting, see section 5.4, "Setting the Reference Level."

### **LEVEL UNIT dBm dBm/nm**

When the vertical axis is log scale, the display toggles between dBm and dBm/nm.

dBm: Power per resolution (absolute power)

dBm/nm: Power per 1 nm (power density)

For information on the use of dBm and dBm/nm, see "Power Density Display" in section 2.2, "Measurement."

### **LEVEL UNIT mW mW/nm**

When the level axis uses a linear scale, the display switches between nW,  $\mu$ W, mW, or pW (absolute power), and nW/nm,  $\mu$ W/nm, mW/nm or pW/nm (power density).

## 5.3 Sub Scale

### Procedure

The level scale is displayed based on relative values when a differential waveform (based on LOG values) or normalized waveform is displayed. A level scale based on relative values is called a sub scale.

### Displaying the Sub Scale

Following section 6.5, "Displaying MATH Waveforms" or section 6.6, "Normalized Display," you can select a display waveform of differential or normalized.

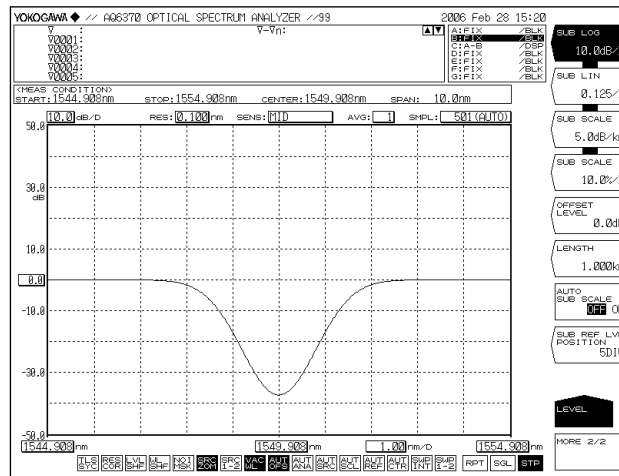

### Automatic Scaling of the Sub Scale

1. Press LEVEL. The soft key menu for vertical axis settings appears.
2. Press the MORE 1/2 soft key. The soft key menu for the sub scale appears.
3. Press the AUTO SUB SCALE OFF ON soft key to select ON.

### Setting the Sub Scale REF Position

1. Press LEVEL.
2. Press the MORE 1/2 soft key.
3. Press the SUB REF LVL POSITION soft key. The REF position setting screen is displayed.
4. Enter a value using the rotary knob, arrow keys, or numeric key pad.

### Note

The sub scale is displayed when a differential waveform (based on LOG values) and normalized waveform are displayed. When these waveforms are displayed over a waveform based on absolute values, the absolute value scale is shown on the left and the relative value scale is shown simultaneously on the right. If the left scale (main scale) is changed to LOG (8 DIV) or linear (10 DIV), the sub scale is displayed to correspond to the DIV count on the main scale.

### Log Display of the Sub Scale

1. Press LEVEL. The soft key menu for vertical axis settings appears.
2. Press the MORE 1/2 soft key. The soft key menu for the sub scale appears.
3. Press the SUB LOG soft key. The sub scale is displayed with the currently specified log scale values. At the same time, the log scale value setting screen is displayed.
4. Enter a value using the rotary knob, arrow keys, or numeric key pad.
5. Press ENTER.

### Setting the Sub Scale Units to dB/km

1. Press LEVEL.
2. Press the MORE 1/2 soft key.
3. Press the SUB SCALE \*\*. \*dB/km soft key. The instruments of the sub scale change to dB/km. At the same time, the log scale value setting screen is displayed.
4. Enter a value using the rotary knob, arrow keys, or numeric key pad.
5. Press ENTER.

When displaying the loss characteristics of the optical fiber per unit of length (km)

6. Continuing on from step 5, press the LENGTH soft key. The optical fiber length entry screen appears.
7. Enter a value using the rotary knob, arrow keys, or numeric key pad.
8. Press ENTER.

### Setting the Sub Scale Offset Value

1. Press LEVEL.
2. Press the MORE 1/2 soft key.
3. Press the OFFSET LEVEL soft key. The offset value (sub scale REF value) setting screen is displayed.
4. Enter a value using the rotary knob, arrow keys, or numeric key pad.
5. Press ENTER.

### Setting the Sub Scale to Linear Display

1. Press LEVEL. The soft key menu for vertical axis settings appears.
2. Press the MORE 1/2 soft key. The soft key menu for the sub scale appears.
3. Press the SUB LIN soft key. The sub scale is displayed with the currently specified linear scale values. At the same time, the linear scale value setting screen is displayed.
4. Enter a value using the rotary knob, arrow keys, or numeric key pad.
5. Press ENTER.

### Setting the Sub Scale Units to %/D

1. Press LEVEL.
2. Press the MORE 1/2 soft key.
3. Press the SUB SCALE \*\*.\*/D soft key. The instruments of the sub scale display change to %. At the same time, the log scale value setting screen is displayed.
4. Enter a value using the rotary knob, arrow keys, or numeric key pad.
5. Press ENTER.

### Setting the Sub Scale Lower-End Value

1. Press LEVEL.
2. Press the MORE 1/2 soft key.
3. Press the SCALE MIN soft key. The sub scale lower end value setting screen is displayed.
4. Enter a value using the rotary knob, arrow keys, or numeric key pad.
5. Press ENTER.

### Explanation

#### **SUB SCALE \*\*.\*/dB/km**

(Setting the sub scale to dB/km)

The setting range is 0.1 to 10.0 dB/km. Settings can be adjusted in steps of 0.1. If you press the COARSE key you can change the numerical value in 1-2-5 steps, for example: 1dB/DIV -> 2dB/DIV -> 5dB/DIV.

When the setting is changed, the displayed waveform is redrawn according to the changed scale.

#### **SUB SCALE \*\*.\*%/D**

(Sets the sub scale to %.)

The setting range is 0.5 to 125 %/D. Settings can be adjusted in steps of 0.1. The value changes in steps of 1-2-5 if you press the COARSE key.

When the setting is changed, the displayed waveform is redrawn according to the changed scale.

#### **OFFSET LEVEL**

(Sets the offset value. This is enabled when the sub scale is dB/D or dB/km.)

The range that can be set is as follows.)

For dB/D: 0–±99.9 dB. Settings can be adjusted in steps of 0.1. The value changes in steps of 1 if you press the COARSE key.

For dB/km: 0–± 99.9 dB/km in steps of 0.1.

#### **SCALE MIN**

(Sets the scale lower-end value. This is available when the sub scale is LIN or %.)

The range that can be set is as follows.)

For LIN: 0 to the sub scale value (\*\*.\* /D) x 10

For %: 0 to the sub scale value (\*\*.\* %/D) x 10

#### **LENGTH \*\*.\*km**

(Sets the length of the optical fiber. This is available when the sub scale is dB/km.)

The setting range is 0.001 to 99.999 km. Settings can be adjusted in steps of 0.001. The value changes in steps of 1-2-5 if you press the COARSE key.

#### **AUTO SUB SCALE OFF/ON**

(Turns OFF/ON the function for automatically scaling the sub scale following calculation.)

When set to ON, during trace C display, SUB LOG or SUB LIN and OFFSET LEVEL change automatically. When these are changed, the displayed waveform is redrawn according to the changed scale.

When set to ON,  is displayed at the bottom of the screen in inverse video.

#### **SUB REF LVL POSITION \*\*.\*/DIV**

(Sets the sub scale REF position.)

The REF position is set at DIV number \*\*, counting from the bottom of the screen.

The setting range is 0 to 12. Settings can be adjusted in steps of 1. The value changes in steps of 1-2-5 if you press the COARSE key.

## 5.4 Setting the Reference Level

### Procedure

There are two ways of setting the reference level.

- Press the **REF LEVEL** soft key.
- Use the one-action key.

The following explains these procedures.

### Settings by Pressing the REF LEVEL Soft Key (Log Scale)

1. Press **LEVEL**. The soft key menu for vertical axis settings appears along with the reference level setting screen.
2. When the vertical axis is not using a log scale, press the **LOG SCALE** soft key. If a log scale is displayed, continue to step 4.
3. Press the **REF LEVEL** soft key. The reference level setting screen is displayed.
4. Enter a reference value using the rotary knob, arrow keys, or numeric key pad.
5. Press **ENTER**.

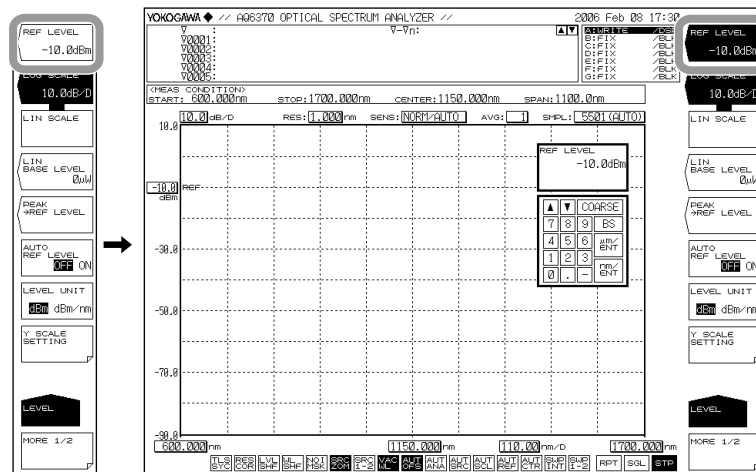

### Note

The vertical axis setting is applied in real time on the waveform display.

## 5.4 Setting the Reference Level

### Setting by Pressing the REF LEVEL Soft Key (Linear Scale)

1. Press LEVEL. The soft key menu for vertical axis settings appears along with the reference level setting screen.
2. When the vertical axis is not using a linear scale, press the LIN SCALE soft key. If a linear scale is displayed, continue to step 4.
3. Press the REF LEVEL soft key. The reference level setting screen is displayed.
4. Enter a reference value using the rotary knob, arrow keys, or numeric key pad. When a value is input a soft key menu for selecting the instrument appears.
5. Press the soft key corresponding to the desired units. The reference level is set.

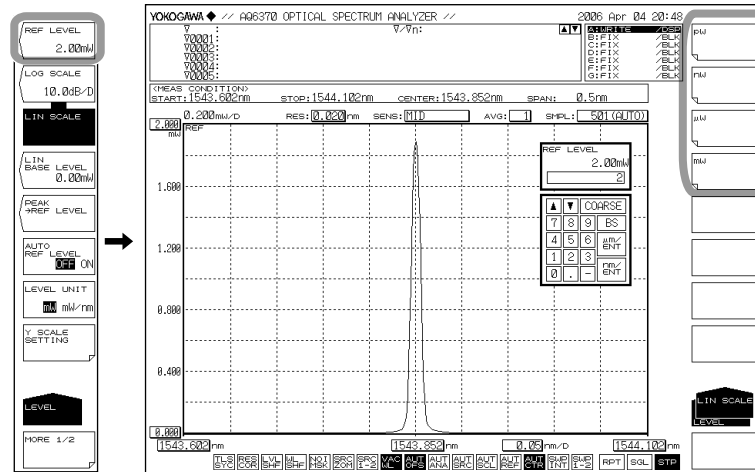

### Note

When entered with the rotary knob or arrow keys, the reference level is set using the current units.

## Setting by Using the One-Action Key

Sets the peak level of the waveform as the reference level.

1. Press **LEVEL**.
2. Press the **PEAK -> REF LEVEL** soft key. The specified reference level is displayed, and the displayed waveform is redrawn according to the changed reference level.

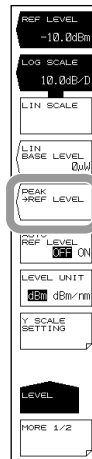

Automatically sets the peak level of the waveform measured every sweep as the reference level.

3. Continuing on from step 1, press the **AUTO REF LEVEL OFF/ON** soft key to select ON.

### Note

- Sets the peak level of the measured waveform of the active trace as the reference level.
- This does not operate if the active trace is not set to WRITE (i.e., if it is set to MAX HOLD, MIN HOLD, CALCULATE, or ROLL AVG).
- When set to ON, **ALT REF** is displayed at the bottom of the screen in inverse video.

Sets the moving marker level as the reference level.

1. Press **MARKER**.
2. With the moving marker displayed, press the **MARKER-> REF LEVEL** soft key. The specified reference level is displayed, and the displayed waveform is redrawn according to the changed reference level.

For details on displaying moving markers, see the explanation in section 6.8.



### Explanation

#### Log Scale (REF LEVEL)

The setting range for the log scale reference level is -90.0–30.0 dBm. Settings can be adjusted in steps of 0.1. The value changes in steps of 1 if you press the COARSE key.

#### Linear Scale (REF LEVEL)

The setting range for the linear scale reference level is 1.00 pW–1000 mW.

When 1.00 to 9.99 (pW, nW,  $\mu$ W, mW), can be set in steps of 0.01.

When 10.0 to 99.9 (pW, nW,  $\mu$ W, mW), can be set in steps of 0.1.

When 100 to 999 (pW, nW,  $\mu$ W, mW), can be set in steps of 1.

If you press the COARSE key you can change the setting in 1-2-5 steps,

for example: 1pW -> 2pW -> 5pW -> 10pW -> 20pW.

If you make a change such as changing 999 to 1.00 or 1.00 to 999, the instrument will be changed.

(Example: Changing pW to nW or changing nW to pW)

#### One-Action Keys

This is the general name for a key that uses data from the active trace waveform (the currently displayed waveform) to set measurement conditions.

Setting conditions requires that a waveform is displayed for the active trace.

##### PEAK → REF LEVEL

Sets the peak level of the waveform of the active trace to the reference level.

Displays the specified reference level (peak level value) and waveform in the reference level setting screen. The reference level setting can be changed after being set initially.

The setting can be changed within the range of -90.0–+30.0 dBm for LOG scale, or 1.00 pW–1000 mW for linear scale. If the peak level value exceeds the allowed range, it is set to the nearest value in the range and a warning is displayed.

##### MARKER → REF LEVEL

This key is used to set the moving marker level as the reference level.

Displays the specified reference level and waveform in the reference level setting screen.

The reference level setting can be changed after being set initially. The setting can be changed within the range of -90.0–+30.0 dBm for LOG scale, or 1.00 pW–1000 mW for linear scale.

If the moving marker value exceeds the allowed range, it is set to the nearest value in the range and a warning is displayed. In the following states, the MARKER → REF LEVEL key is disabled.

- When the moving marker is OFF
- When both split screens are on HOLD

## 5.5 Center Wavelength (Center Frequency) Setting

### Procedure

The following are three ways of setting the center wavelength (center frequency).

- Press the **CENTER WL** or **CENTER FREQ** soft key.
- Press the **START WL/STOP WL** or **START FREQ/STOP FREQ** soft key.
- Use the one-action key (soft key).

The following explains these procedures.

### Setting by Pressing the CENTER WL or CENTER FREQ Soft Key

1. Press **CENTER**. The soft key menu for center wavelength or center frequency appears along with the center wavelength or center frequency setting screen.
2. Press the **CENTER WL** soft key for center wavelength or the **CENTER FREQ** soft key for center frequency.
3. Enter a center wavelength or center frequency using the rotary knob, arrow keys, or numeric key pad.
4. Press **nm/ENTER**.

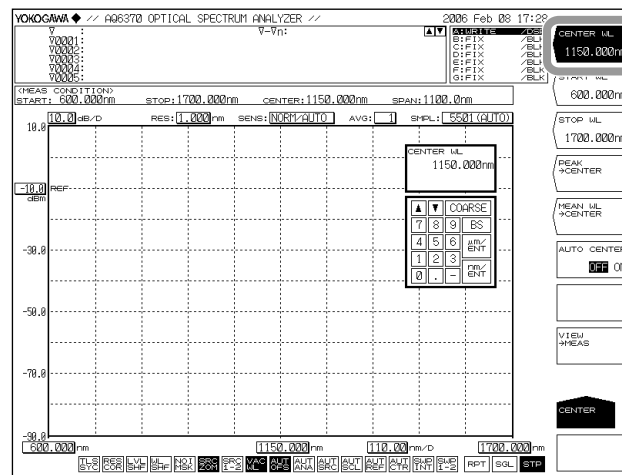

### Note

- It is not necessary to press **nm/ENTER** when using the rotary knob or arrow keys.
- The set value is applied to the measurement conditions area.
- When a setting is changed, **NEW** appears in the measurement conditions area.
- If a value outside the setting range is entered, the nearest permitted value is set.

For instructions on switching the wavelength and frequency displays, see section 5.2.

## 5.5 Center Wavelength (Center Frequency) Settings

### Setting with the START WL/STOP WL or START FREQ/STOP FREQ Soft Key

1. Press **CENTER**. The soft key menu for center wavelength or center frequency settings appears.

### Setting the Start Wavelength or Start Frequency

2. Press the **START WL** soft key for start wavelength or the **START FREQ** soft key for start frequency. The start wavelength or start frequency setting screen is displayed.
3. Enter a start wavelength or start frequency using the rotary knob, arrow keys, or numeric key pad.
4. Press **nm/ENTER**.

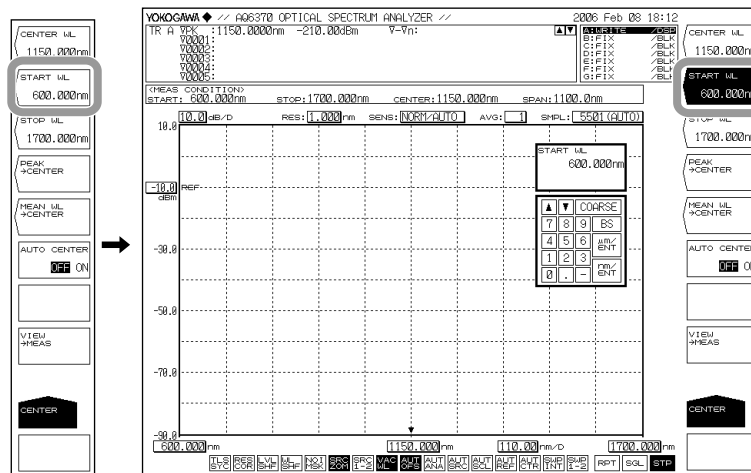

### Setting the Stop Wavelength or Stop Frequency

5. Press the **STOP WL** soft key for stop wavelength or the **STOP FREQ** soft key for stop frequency. The stop wavelength or stop frequency setting screen is displayed.
6. Enter a stop wavelength or stop frequency using the rotary knob, arrow keys, or numeric key pad.
7. Press **nm/ENTER**.

### Note

- It is not necessary to press **nm/ENTER** when using the rotary knob or arrow keys.
- The set value is applied to the measurement conditions area.
- When a setting is changed, **NEW** appears in the measurement conditions area.
- If a value outside the setting range is entered, the nearest permitted value is set.

For instructions on switching the wavelength and frequency displays, see section 5.2.

### Setting by Using the One-Action Key

You can set the center wavelength or center frequency by pressing the one-action key one time in the soft key menu that appears when you press CENTER.

1. Press CENTER.
2. For the center wavelength setting, when using peak wavelength or peak frequency, press the **PEAK->CENTER** soft key. For THRESH 3dB center wavelength or center frequency, press the **MEAN WL->CENTER** soft key. When using the currently displayed ZOOM scale, press the **VIEW->MEAS** soft key. The specified center wavelength or center frequency is displayed, and the displayed waveform is redrawn according to the changed center wavelength.

The peak wavelength or peak frequency of the waveform measured every sweep can be set automatically to the center wavelength or center frequency.

3. Continuing on from step 1, press the AUTO CENTER OFF/ON soft key to select ON.

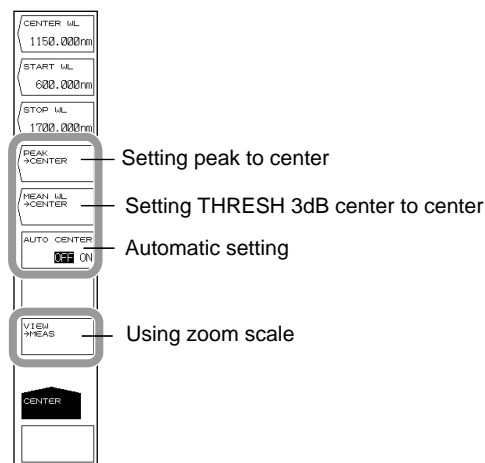

Also, you can set the wavelength of the moving marker placed on the measured waveform as the center wavelength or center frequency.

1. Press MARKER.
2. With the moving marker displayed, press the MARKER-> CENTER soft key. The specified center wavelength or center frequency is displayed, and the displayed waveform is redrawn according to the changed center wavelength or center frequency.

For details on displaying moving markers, see the explanation in section 6.8.



### Explanation

#### Center Wavelength

The setting range is 600.000 to 1700.000 nm.

If you press the COARSE key you can use the rotary knob or arrow keys to change the numerical value in 1 nm steps. The value changes in 0.1 nm steps if you do not press the COARSE key.

#### Start Wavelength

The setting range is 50,000 to 1700.000 nm.

#### Stop Wavelength

The setting range is 600.000 to 2250.000 nm.

#### Note

---

- When the start or stop wavelength is set, one wavelength becomes fixed, and this changes the value of the sweep width. In addition, the center wavelength value is also changed at the same time.
  - Changing the center wavelength does not change the sweep width.
- 

#### AUTO CENTER OFF/ON

This key sets whether the PEAK→CENTER soft key functions for each sweep.

When this key is set to ON, the peak is searched in the active trace waveform and set as the center wavelength automatically for each sweep. The active trace must be set to WRITE. When ON is selected,  at the bottom of the screen is displayed in reverse video.

#### One-Action Keys

This is the general name for a key that uses data from the active trace waveform (the currently displayed waveform) to set measurement conditions.

Setting conditions requires that a waveform is displayed for the active trace.

#### PEAK →CENTER

Sets the wavelength of the peak value to the center wavelength.

After execution, the center wavelength set in the center wavelength setting screen is displayed. The center frequency can be changed after the setting is made initially.

#### MEAN WL→CENTER

Sets the average of two wavelengths falling below the threshold value (3 dB) from the waveform peak of the active trace to the center wavelength. The center wavelength can be changed after the setting is made initially.

#### VIEW→MEAS

This key is used to set the currently set ZOOM scale (ZOOM CENTER, ZOOM SPAN, ZOOM START, ZOOM STOP) as the measurement scale (CENTER, START, STOP, SPAN).

When you press this key, the current waveform display scale is set as the measurement scale for the next sweep.

### Center Frequency

The setting range is 176.5000 to 500.0000 THz.

If you press the COARSE key you can use the rotary knob or arrow keys to change the numerical value in 0.1 THz steps. The value changes in 0.01 THz steps if you do not press the COARSE key.

### Start Frequency

The setting range is 11.5000 to 500.0000 THz.

### Stop Frequency

The setting range is 176.5000 to 665.0000 THz.

#### Note

- When the start or stop frequency is set, one frequency becomes fixed, and this changes the value of the sweep width. In addition, the center frequency value is also changed at the same time.
- Changing the center frequency does not change the sweep width.

### AUTO CENTER OFF/ON

This key sets whether the PEAK→CENTER soft key functions for each sweep.

When this key is set to ON, the peak is searched in the active trace waveform and set as the center frequency automatically for each sweep. The active trace must be set to WRITE. When ON is selected,  at the bottom of the screen is displayed in reverse video.

### One-Action Keys

You can set the center frequency with the one-action key in the same manner as for the wavelength.

#### PEAK →CENTER

Sets the frequency of the waveform peak value of the active trace to the center frequency. After execution, the center frequency set in the center frequency setting screen is displayed. The center frequency can be changed after the setting is made initially.

#### MEAN WL→CENTER

Sets the average of two frequencies falling below the threshold value (3 dB) from the waveform peak of the active trace to the center frequency. The center frequency can be changed after the setting is made initially.

#### VIEW→MEAS

This key is used to set the currently set ZOOM scale (ZOOM CENTER, ZOOM SPAN, ZOOM START, ZOOM STOP) as the measurement scale (CENTER, START, STOP, SPAN). When you press this key, the current waveform display scale is set as the measurement scale for the next sweep.

## 5.6 Sweep Width Settings

### Procedure

The following are three ways of setting the sweep width.

- Press the **SPAN WL** or **SPAN FREQ** soft key.
- Press the **START WL/STOP WL** or **START FREQ/STOP FREQ** soft key.
- Use the one-action key (soft key).

The following explains these procedures.

### Setting by Pressing the SPAN WL or SPAN FREQ Soft Key

1. Press **SPAN**. The soft key menu for sweep width settings appears along with the sweep width setting screen.
2. Press **SPAN WL** for wavelength measurement or **SPAN FREQ** for frequency measurement.
3. Enter a sweep width using the rotary knob, arrow keys, or numeric key pad.
4. Press **nm/ENTER**.

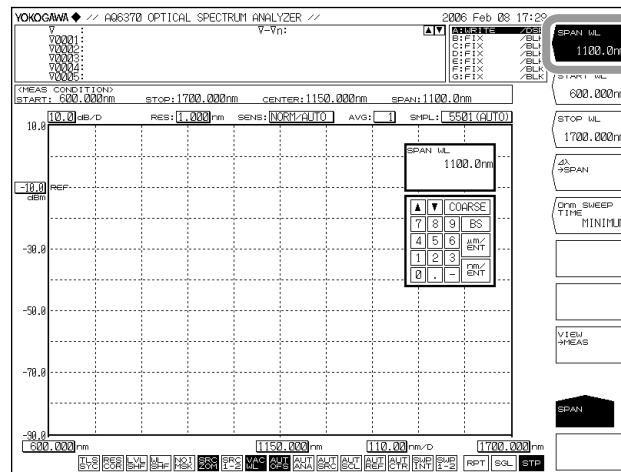

### Note

- It is not necessary to press nm/ENTER when using the rotary knob or arrow keys.
- The set value is applied to the measurement conditions area.
- When a setting is changed, **NEW** appears in the measurement conditions area.
- If a value outside the setting range is entered, the nearest permitted value is set.

For instructions on switching the wavelength and frequency displays, see section 5.2.

## Setting with the START WL/STOP WL or START FREQ/STOP FREQ Soft Key

1. Press **SPAN**. The soft key menu for sweep width settings appears.

### Setting the Start Wavelength or Start Frequency

2. Press the **START WL** soft key for start wavelength or the **START FREQ** soft key for start frequency. The start wavelength or start frequency setting screen is displayed.
3. Enter a start wavelength or start frequency using the rotary knob, arrow keys, or numeric key pad.
4. Press **nm/ENTER**.

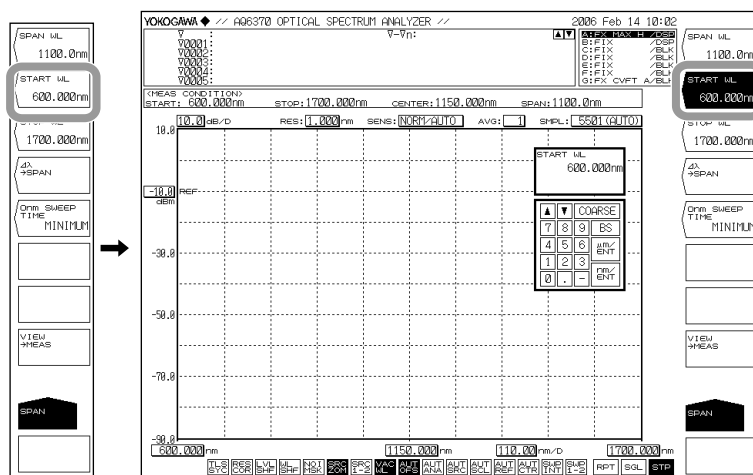

### Setting the Stop Wavelength or Stop Frequency

5. Press the **STOP WL** soft key for stop wavelength or the **STOP FREQ** soft key for stop frequency. The stop wavelength or stop frequency setting screen is displayed.
6. Enter a stop wavelength or stop frequency using the rotary knob, arrow keys, or numeric key pad.
7. Press **nm/ENTER**.

#### Note

- It is not necessary to press nm/ENTER when using the rotary knob or arrow keys.
- The set value is applied to the measurement conditions area.
- When a setting is changed, **NEW** appears in the measurement conditions area.
- If a value outside the setting range is entered, the nearest permitted value is set.

For instructions on switching the wavelength and frequency displays, see section 5.2.

### Setting by Using the One-Action Key

#### Setting the Sweep Width from the Measured Waveform

1. Press SPAN.
2. Press the  $\Delta\lambda \rightarrow$  SPAN soft key. Sets the span as six times the RMS 20 dB width of the active trace measurement waveform.



#### Sets spacing between line markers 1 and 2 for sweep width.

1. Press MARKER.
2. Press the MORE 1/3 soft key.
3. With the line markers 1 and 2 displayed, press the MKR L1-L2 -> SPAN soft key. Sets spacing between line markers 1 and 2 for sweep width.

For details on displaying line markers, see the explanation in section 6.8.

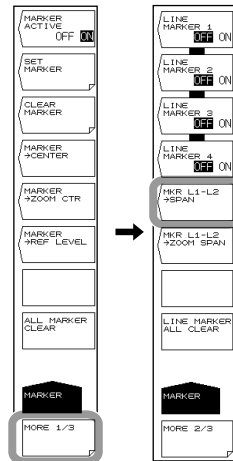

#### Note

- If only one of the line markers is displayed, for L1, the wavelength on the right edge of the screen is set to the measurement stop wavelength. For L2, the wavelength on the left edge of the screen is set to the measurement start wavelength.
- The MKR L1-L2 ->SPAN soft key cannot be used under the following conditions.
  - When both L1 and L2 are OFF.
  - When both SPLIT screens are on HOLD.
  - When the span of the active trace is 0 nm.

**Explanation****Wavelength Sweep Width**

The available setting range is 0, and 0.1 to 1100.0 nm. If you press the COARSE key you can use the rotary knob or arrow keys to change the numerical value in 1-2-5 steps. The value changes in 1 nm steps if you do not press the COARSE key.

**Start Wavelength**

The setting range is 50,000 to 1700.000 nm. The value changes in 1 nm steps if you press the COARSE key. If you do not press it, the value changes in 0.1 nm steps.

**Stop Wavelength**

The setting range is 600.000 to 2250.000 nm. The value changes in 1 nm steps if you press the COARSE key. If you do not press it, the value changes in 0.1 nm steps.

**Note**

- Setting the sweep width changes the start wavelength and stop wavelength. The center wavelength/frequency does not change.
- Changing the center wavelength changes the start wavelength and stop wavelength. The sweep width does not change. When the start or stop wavelength is set, one wavelength becomes fixed, and this changes the value of the sweep width. In addition, the center wavelength value is also changed at the same time.

**One-Action Keys**

This is the general name for a key that uses data from the active trace waveform (the currently displayed waveform) to set measurement conditions.

Setting conditions requires that a waveform is displayed for the active trace.

 **$\Delta\lambda$ →SPAN**

Sets the sweep width as six times the spectrum width (threshold 20 dB ) of the active trace measurement waveform with the RMS method.

**MKR L1-L2 →SPAN**

Sets spacing between line markers 1 and 2 for sweep width.

The setting range is 0.1 to 1100 nm (in 0.1 nm steps).

**Frequency Sweep Width**

The allowed settings are 0 and the range of 0.01 to 330.000 THz.

If you press the COARSE key you can use the rotary knob or arrow keys to change the numerical value in 1-2-5 steps. The value changes in 0.1 THz steps if you do not press the COARSE key.

**Start Frequency**

The setting range is 11.5000 to 500,000 THz.

The value changes in 0.1 THz steps if you press the COARSE key. If you do not press it, the value changes in 0.01 THz steps.

**Stop Frequency**

The setting range is 176.5000 to 665.0000 THz.

The value changes in 0.1 THz steps if you press the COARSE key. If you do not press it, the value changes in 0.01 THz steps.

## 5.7 Wavelength (Frequency) Resolution Settings

### Procedure

1. Press **SETUP**. The soft key menu for sweep condition settings appears.
2. Press the **RESOLUTION** soft key. The resolutions that can be set appear in the soft key menu.
3. Press the soft key corresponding to the desired resolution. The screen returns to the previous stage, and the value specified by the **RESOLUTION** soft key is displayed.

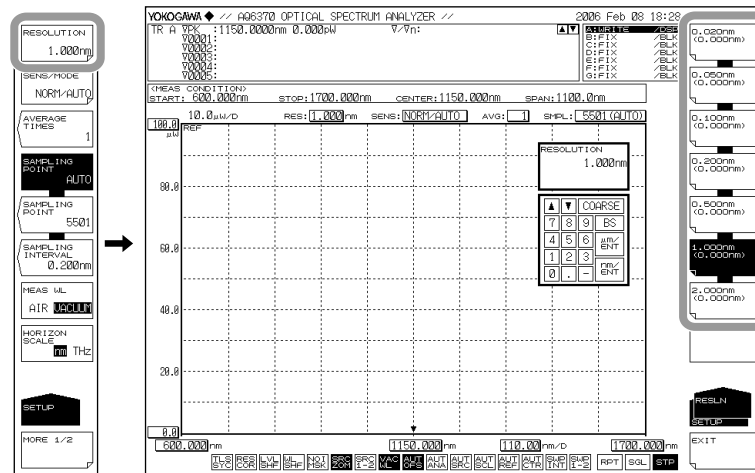

### Note

- When entering an arbitrary value using the rotary knob, arrow keys, or numeric key pad in the resolution screen that appears when you press the RESOLUTION soft key, the soft key value that is closest to the entered value is set.
- The instrument displays **UNCAL** if the settings for span, the number of sampling points, and the resolution are inappropriate. When **UNCAL** is displayed, normal measurement is not possible.

### Corrective Action When “UNCAL” Is Displayed

Perform the following steps.

- Decrease the span.
- Increase the number of samples.
- Lower the resolution (increase the value).
- Select AUTO with the SAMPLING POINT soft key under SETUP.

The “UNCAL” display disappears if the span, number of samples, and the resolution settings are appropriate.

### Correcting the Resolution

1. Press **SETUP**. The soft key menu for sweep condition settings appears.
2. Press the **MORE 1/2** soft key.
3. Press the **RESOLN CORRECT OFF ON** soft key. Each time you press the soft key the setting toggles between ON and OFF.

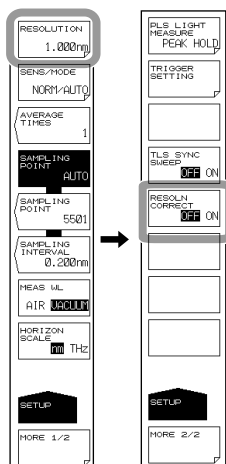

### Note

- Since the wavelength resolution function is set according to the monochromator slit width, the setting resolution and actual resolution may not match. For this instrument, if the resolution is set to 0.1 nm, the actual resolution will be 0.09 nm for a 1310 nm wavelength, and 0.06 nm for a 1550 nm wavelength.
- If the resolution correction function is turned ON, measured data is processed by the software so that it matches the set resolution.  
In the following cases, the resolution correction function has no effect even when turned ON.
  - When the set resolution is 0.02 nm
  - When the measured wavelength is 1250 nm or less
- Turn OFF the resolution correction function when performing measurement for which the level accuracy is guaranteed.

**Explanation**

**Conditions under Which “UNCAL” Is Displayed**

“UNCAL” is displayed when a single or repeat sweep is started based on the following relationship between span, setting resolution, and set number of samples:

$$\frac{\text{Span}}{\text{Setting resolution}} \times 5 < \text{Set number of samples} - 1$$

**Waveforms with Resolutions of 0.020 nm**

When the resolution is set to 0.020 nm for measurements of a light source such as a DFB laser in which with the spectral width is narrower than the instrument’s resolution, very small spikes may occur at the skirts of the waveform. This type of spike occurs due to characteristics of the optical block and is not an indication of any problem. Even if such spikes occur, satisfactory performance in terms of resolution, dynamic range, and the like can be ensured. These spikes will disappear if the resolution is set to a coarser value.

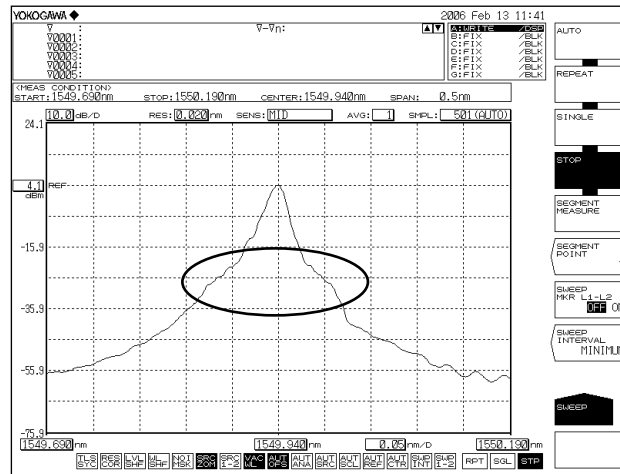

**Ripples in the 1350–1450 nm Area**

Water (OH-) ions present in the monochromator absorb light in the 1350–1450 nm area, resulting in ripples in the measurement waveform. Either set a coarser resolution or use the monochromator in a lower-humidity environment to reduce the amount of ripples.

# 5.8 Sampling Point/Interval Settings

## Procedure

The following are three ways in which the number of samples can be entered.

- Setting the number of samples directly
- Setting by the sampling interval
- Automatically setting the optimum number of samples or the sampling interval according to the sweep width (span) and resolution setting

1. Press **SETUP**. The soft key menu for sweep condition settings appears.
2. Press the **SAMPLING POINT** or **SAMPLING INTERVAL** soft key to set the sampling point or sampling interval, respectively. To automatically set the sampling points and interval according to the span and wavelength (frequency) resolution settings, press **SAMPLING POINT AUTO**. The sampling points or interval setting screen is displayed.

If you pressed **SAMPLING POINT AUTO**, the sampling points and interval are set automatically.

3. Enter a number of samples or interval using the rotary knob, arrow keys, or numeric key pad.
4. Press **ENTER**. The sampling points or interval are set.

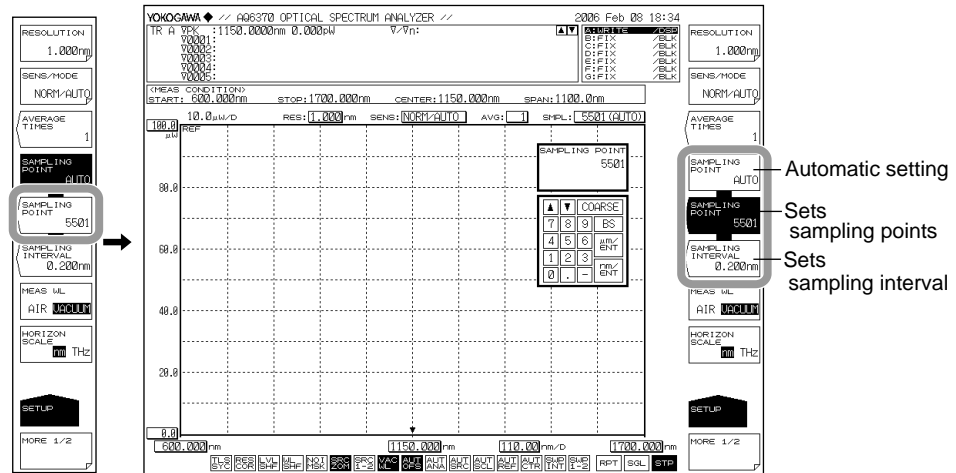

### Note

- The instrument displays **UN CAL** if the settings for span, the number of sampling points, and the resolution are inappropriate. When **UN CAL** is displayed, normal measurement is not possible.
- See section 5.7 for the corrective actions when **UN CAL** is displayed.

### Explanation

#### Sampling points (the number of points measured in a single sweep)

Sampling points are the number of points measured within the range of the specified span.

The setting range is 101 to 50001.

#### Relationship between Sampling Points, Interval, and Span

The relationship between the number of samples, the interval, and the span is as follows.

$$\text{Number of sampling points} = \frac{\text{Span}}{\text{Interval}} + 1$$

Given the same span, the sampling points are automatically determined when the interval is known, and viceversa.

For information about the allowed setting for the span, see the explanation in section 5.6, "Sweep Width Setting."

#### **Note**

---

- Increasing the number of sampling points or decreasing the sampling interval reduces the sweeping speed.
  - Settings that would cause the number of samples in the sweep range to be extremely few cannot be entered.
  - If the setting for the number of samples is changed, the sampling interval value also changes accordingly.
- 

#### Relationship with Wavelength (Frequency) Resolution

If settings are entered such that the sampling interval determined by the settings for the span and number of samples is extremely long relative to the wavelength (frequency) resolution, data may be lost. Enter settings that are appropriate for the resolution.

## 5.9 Sensitivity Settings

### Procedure

1. Press **SETUP**. The soft key menu for sweep condition settings appears.
2. Press the **SENS/MODE** soft key. Seven sensitivity choices appear in the soft key menu.
3. Press the soft key corresponding to the desired choice. The screen returns to the previous stage, and the value specified by the **SENS/MODE** soft key is displayed.

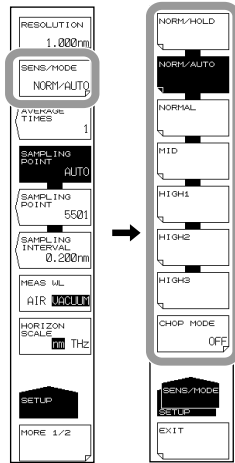

### CHOP MODE ON/OFF

2. Press the **SENS/MODE** soft key.
3. Press the **CHOP MODE** soft key.
4. Press the **CHOP** or **SWITCH** soft key.
5. To turn CHOP MODE OFF, press the **OFF** soft key.

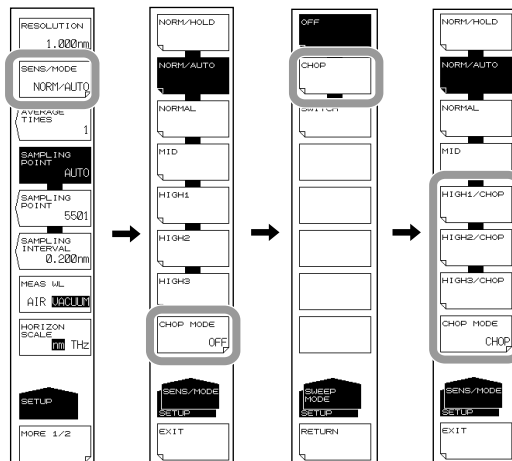

### Note

If you set the CHOP MODE to CHOP or SWITCH, the corresponding sensitivity soft key display will change to HIGH1/CHOP–HIGH3/CHOP or HIGH1/SW–HIGH3/SW.

**Explanation**

**CHOP MODE**

This mode activates the internal chopper of the monochromator. Stray light specific to the monochromator is reduced by turning the chopper. When CHOP MODE is set to CHOP or SWITCH, measurements of better S/N can be made. You can set the CHOP MODE to CHOP if the sensitivity setting is HIGH1–HIGH3. You can set the CHOP MODE to SWITCH if the sensitivity setting is HIGH1–HIGH3 or MID.

**CHOP MODE Function List**

CHOP MODE	Function	Merit	Defect
OFF	Measurement according to the stray light.  Stray light suppression ratio: 40 dB or more	Measurement time is rapid even for high sensitivity measurements.	Since the stray light is also measured, the low level component is not accurate if the light source is of high power.
CHOP	High dynamic measurement using internal modulation.  Stray light suppression ratio: 60 dB or more	Measurement can be taken with stray light removed. Long-duration, high sensitivity measurements possible since offset does not change.	Measurement time is long.
SWITCH	Two sweeps per measurement are performed. The first sweep measures the stray light component, and high dynamic measurement is possible through subtraction.  Stray light suppression ratio: 60 dB or more	Short-duration measurement can be taken with stray light removed.	If the measurement duration is long, it is influenced by temporal changes in the measured light.

**Stray Light from the Monochromator**

The instrument has a newly designed, high-performance monochromator. Depending on the measurement conditions, stray light at a level 30 to 50 dB below the original spectrum, as well as other stray light specific to the monochromator may occur in wavelength areas 100 to 200 nm from the peak wavelength. If this stray light is likely to have a severe impact on measurements, the sensitivity can be set to HIGH 1–3 and CHOP MODE can be set to CHOP or SWITCH in order to reduce the effects of the stray light.

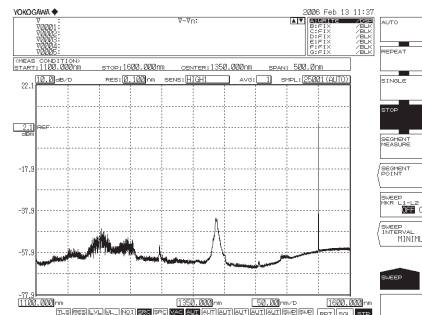

Waveform with CHOP MODE OFF

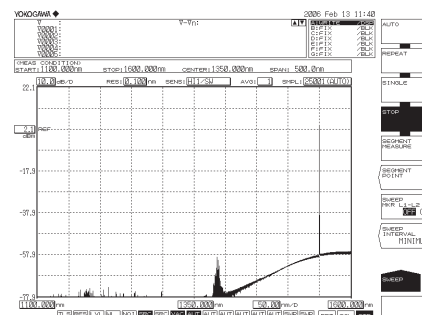

CHOP MODE set to SWITCH

## 5.10 Averaging Times Setting

### Procedure

1. Press **SETUP**. The soft key menu for sweep condition settings appears.
2. Press the **AVERAGE TIMES** soft key. The averaging times setting screen is displayed.
3. Enter a number of averaging times using the rotary knob, arrow keys, or numeric key pad.
4. Press **ENTER**. The value specified by the **AVERAGE TIMES** soft key is displayed.

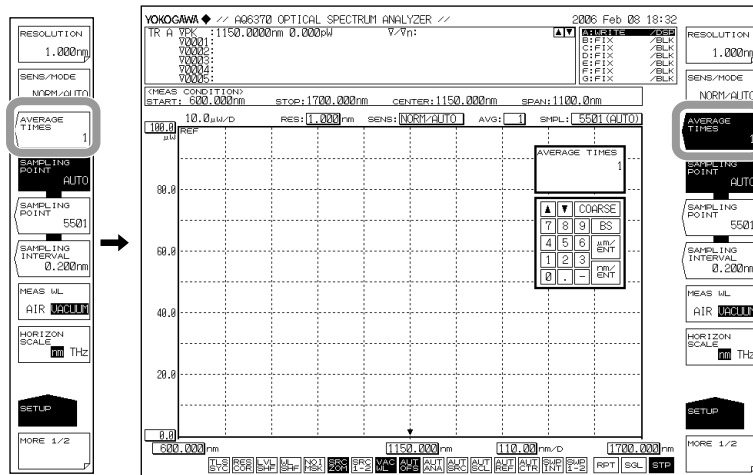

### Note

Increasing the averaging times reduces the sweeping speed but the S/N improves.

### Explanation

#### AVERAGE TIMES

This key is used to set the average times for each point.

The setting range is 1 to 999.

If you press the **COARSE** key you can use the rotary knob or arrow keys to change the numerical value in 1-2-5 steps. The value changes in 1 step if you do not press the **COARSE** key.

## 5.11 Trace Settings

### Procedure

The following explains selecting a trace, writing waveform data, and displaying the data on screen.

1. Press **TRACE**. The soft key menu for traces appears.
2. Press the **ACTIVE TRACE** soft key. Traces A through G appear in soft keys.
3. Press the soft key corresponding to the trace you wish to use. That trace is set as the active trace (in the example below, this will be trace B).
4. Press the **VIEW B** soft key and select **DISP**.
5. Press the **WRITE B** soft key. Trace B is placed in write mode.

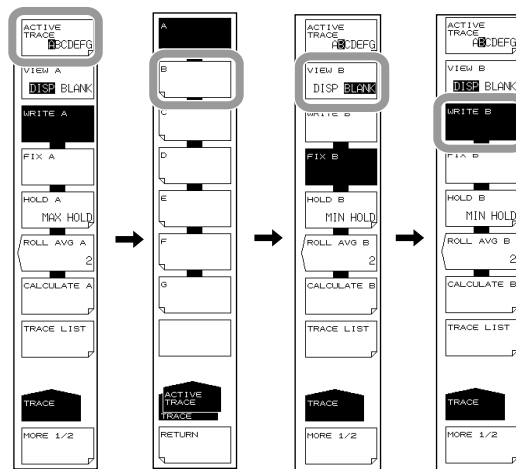

### Note

Waveforms of traces for which VIEW A–VIEW G are set to BLANK cannot be displayed on screen.

**Explanation****Active Trace**

Active trace refers to a target trace to which settings and changes can be applied.

A trace shows a waveform and measurement conditions. The instrument has a total of seven independent traces (A through G). You can specify Show/Hide on each trace, and display multiple traces in the waveform screen.

The following explains the soft keys related to trace settings.

**ACTIVE TRACE...ABCDEFG**

Selects the active trace from among traces A to G.

You can also switch the active trace using the mouse by clicking TRACE display A through G on the screen.

**Displaying Traces**

Selects whether or not to display the active trace on screen.

**VIEW @...DISP / BLANK**

"VIEW @ DISP": Displays the waveform on the screen. The trace display changes to "DSP".

"VIEW @ BLANK": Does not display the waveform on the screen. The trace display changes to "BLK".

When you press this key, the highlight toggles between "VIEW @ DISP" and "VIEW @ BLANK".

Note that if BLANK is set, markers applied to the trace set in DISP will be cleared.

The "at" (@) symbol indicates the currently selected trace. One is included from A–G.

**Write Mode****WRITE @**

This key is used to set the active trace to write mode.

When a trace is set to write mode, waveform data are written to it and updated during measurement. In addition, the trace display on the side of the data area changes to "WRITE".

The "at" (@) symbol indicates the currently selected trace. One is included from A–G.

**Fix mode****FIX @**

This key is used to set the active trace to data fixing mode.

When a trace is set to this mode, its waveform data do not change even when measurement is performed. Therefore, the waveform on the screen is not overwritten.

The trace display changes to "FIX".

When the FIX soft key is pressed during sweeping, the waveform displayed at that time is fixed.

The "at" (@) symbol indicates the currently selected trace. One is included from A–G.

## 5.12 Measurement Start (Sweep)

### Procedure

1. Press **SWEEP**. The soft key menu regarding sweep appears.
2. Press the **SINGLE** or **REPEAT** soft key. Sweeping begins.
3. To set the sweep interval, press the **SWEEP INTERVAL** soft key. The sweep interval setting screen is displayed.
4. Enter a numerical value using the rotary knob, arrow keys, or numeric keypad, then press **ENTER**.
5. To stop the sweep, press the **STOP** soft key.

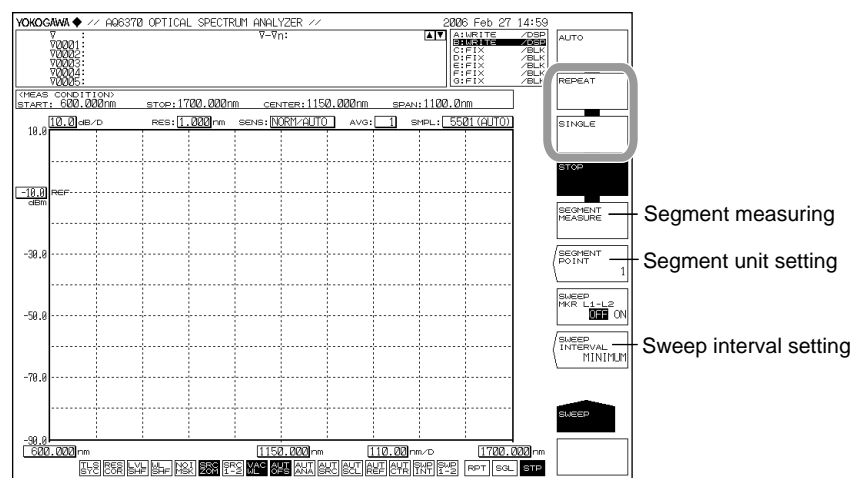

### Note

- Sweeping can also be performed by clicking the sweep icons **RPT** | **SGL** located at the bottom of the screen.
- During a sweep, the sweep bar is displayed below the X axis, indicating conditions during the current sweep.
- During a sweep, a sweep icon indicating the sweep status is displayed in the lower left corner of the screen. (Sweep progress from the start wavelength to the sweep wavelength is indicated as a percentage.)

## Dividing into Segments and Measuring

### Setting the Unit of Segments

2. Continuing on from step 1, press the **SEGMENT POINT** soft key. The segment unit setting screen is displayed.
3. Enter a numerical value using the rotary knob, arrow keys, or numeric keypad, then press **ENTER**.

**Starting the Sweep**

4. Press the **SEGMENT MEASURE** soft key. Only the specified segment unit is measured, and sweeping stops. The first time (only), sweeping begins from the start wavelength.
5. If you press the **SEGMENT MEASURE** soft key again, sweeping of a segment unit begins from the stopped position.
6. Repeat step 5. When the measured number of samples reaches the specified number of samples, segment measurement ends.
7. To stop the sweep while in progress, press the **STOP** soft key.

**Note**

- With segment measurement, sweeping is performed in units of segments.
- If you press the SINGLE key or REPEAT key during segment measurement, segment measurement stops, and sweeping begins from the start wavelength.

**Explanation****SEGMENT MEASURE**

This function divides up the specified number of measurement samples by the segment unit set using the SEGMENT POINT soft key, and performs measurement.

**SEGMENT POINT**

This key is used to set the number of sampling points for performing <SEGMENT MEASURE>. When you press this key, the current number of sampling points is displayed in the parameter entry window. The number of sampling points can be set in the range of 1 to 50,001 in the DATA ENTRY section. When the setting value of SEGEMENT POINT is larger than the value which deducted points in this time from measurement sampling points , it measures to the last sampling points.

**SWEEP INTERVAL**

This key is used to set the time from one sweeping start to the next sweeping start during repeat sweeping.

If the time required for sweeping is greater than the set time, the next sweeping is started immediately after sweeping ends.

When you press this key, the current setting time is displayed in the parameter input window. The setting range is MINIMUM or 1 to 99,999 seconds, and is set in the DATA ENTRY section.

If "0" is entered through the numeric keypad, then MINIMUM is set.

If a setting other than MINIMUM is entered,  is displayed at the very bottom of the screen in inverse video.

## 5.13 Specifying a Sweep Range

### Procedure

#### Sweeping between Line Markers

You can sweep between wavelength line marker 1 and wavelength line marker 2.

1. Set wavelength line marker 1 and wavelength line marker 2 at either end of the range you want to sweep.  
(For the display procedure, see section 6.8, "Displaying Markers.")
2. Press **SWEEP**. The soft key menu regarding sweep appears.
3. Press the **SWEEP MKR L1-L2 OFF/ON** soft key, and select ON. When set to ON,  is displayed at the very bottom of the screen.
4. Press the **REPEAT** or **SINGLE** soft key. Sweeping between line markers begins.
5. To cancel, press the **SWEEP MKR L1-L2 OFF/ON** soft key, and select OFF. Sweeping is performed over the entire screen.

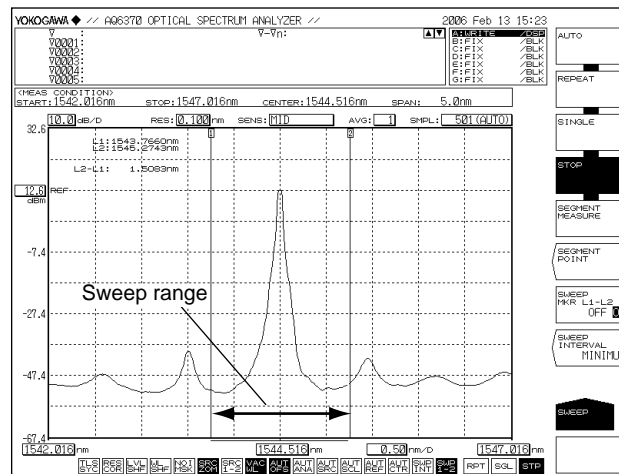

#### Note

- If both L1 and L2 are set, sweeping is executed between line markers 1 and 2.
- If just L1 is set, the sweep occurs over the span from line marker 1 to the right edge of the screen.
- If just L2 is set, the sweep occurs over the span from the left edge of the screen to line marker 2.
- If neither L1 nor L2 is set, analysis is performed from the set start wavelength to the stop wavelength.

## 5.14 Pulse Light Measurement

### Procedure

#### Pulse Light Measurement Settings

1. Press **SETUP**. The soft key menu for sweep condition settings appears.
2. Press the **MORE** soft key. The MORE 2/2 soft key menu is displayed.
3. Press the **PLS LIGHT MEASURE** soft key.
4. Press the **PEAK HOLD** soft key. The peak hold value setting screen is displayed.
5. Enter a peak hold value using the rotary knob, arrow keys, or numeric key pad. A value larger than the period of the pulse light being measured must be entered for the peak hold value.
6. Press **ENTER**.

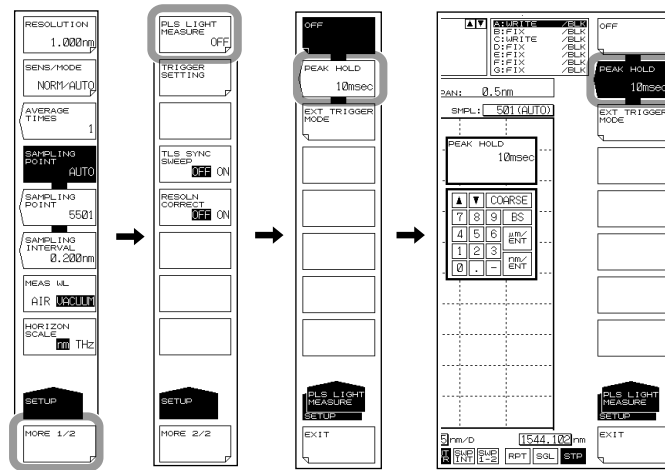

#### Displaying the Pulse Light Measurement Waveform

7. Press **SWEEP**. The soft key menu for sweep appears.
8. Press the **SINGLE** or **REPEAT** soft key. Sweeping begins, and a waveform is displayed.
9. To stop the sweep, press the **STOP** soft key.

#### Note

- An appropriate sensitivity is determined from the pulse width of the measured pulse light. For details, see the table, "Sensitivity Name and Corresponding Pulse Width."
- Enter a value longer than the period of the pulse light being measured for the peak hold value.

**Explanation**

**PLS LIGHT MEASURE**

You can enter pulse light measurement settings and external trigger mode settings.

**PEAK HOLD**

You can set the peak hold value for the pulse light. Pulse light measurement can be carried out based on this.

The setting range is 1 to 9999 ms.

**EXT TRIGGER MODE**

This mode is used to measure pulse light using an external trigger signal. When this key is selected, sweeping is performed in external trigger mode, wherein sampling is done based on an external trigger signal.

For information on external trigger measurement, see section 5.15.

**Measurement Sensitivity and Corresponding Pulse Width**

The measurement sensitivity is determined based on the light pulse width. Select the appropriate sensitivity level based on the pulse width in the table below.

**Sensitivity Name and Corresponding Pulse Width**

Sensitivity setting	CHOP MODE	On-Screen Notation			Corresponding Pulse Width (Min.)
		Normal	PEAK HOLD Setting	EXT TRIG Setting	
NORM/HOLD	OFF	NORM/HOLD	P-NORM/HLD	E-NORM/HLD	PEAK: 100µs EXT: 50µs
NORM/AUTO		NORM/AUTO	P-NORM/AUT	E-NORM/AUT	300µs
NORMAL		NORMAL	P-NORMAL	E-NORMAL	1ms
MID		MID	P-MID	E-MID	3ms
HIGH1		HIGH1	P-HIGH1	E-HIGH1	10ms
HIGH2		HIGH2	P-HIGH2	E-HIGH2	50ms
HIGH3		HIGH3	P-HIGH3	E-HIGH3	200ms
HIGH1	CHOP	HI1/CHOP	P-HI1/CHOP	E-HI1/CHOP	50ms
HIGH2		HI2/CHOP	P-HI2/CHOP	E-HI2/CHOP	200ms
HIGH3		HI3/CHOP	P-HI3/CHOP	E-HI3/CHOP	2000ms
MID	SWITCH	MID/SW	P-MID/SW	E-MID/SW	3ms
HIGH1		HI1/SW	P-HI1/SW	E-HI1/SW	10ms
HIGH2		HI2/SW	P-HI2/SW	E-HI2/SW	50ms
HIGH3		HI3/SW	P-HI3/SW	E-HI3/SW	200ms

## 5.15 External Trigger Measurement

### Procedure

#### Setting the Trigger Input Mode

1. Press **SYSTEM**. The soft key menu regarding the system settings appears.
2. Press the **MORE** soft key. The MORE 2/4 soft key menu is displayed.
3. Press the **TRIG INPUT MODE** soft key. The trigger input mode's setting menu is displayed.
4. To set sample trigger mode or sweep trigger mode, press the **SMPL TRIG** or **SWEEP TRIG** soft key, respectively.

If you set **SWEEP TRIG**, that concludes the settings.

If you press the **EXEC** soft key, the instrument returns to the original screen.

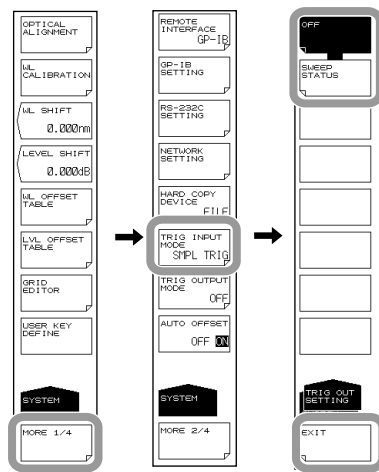

#### Note

- When using a sample trigger, turn TLS SYNC OFF.
- When using a sweep trigger, turn TLS SYNC OFF. Also, TRIGGER SETTING and EXT TRIGGER MODE cannot be set.

### Setting External Trigger Mode (for SMPL TRIG)

5. Press **SETUP**. The soft key menu for sweep condition settings appears.
6. Press the **MORE** soft key. The MORE 2/2 soft key menu is displayed.
7. Press the **PLS LIGHT MEASURE** soft key.
8. Press the **EXT TRIGGER MODE** soft key. External trigger mode is set.

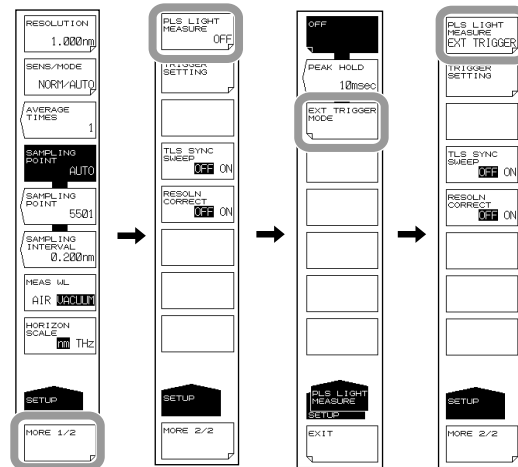

### Setting Trigger Conditions (for SMPL TRIG)

9. Press the **TRIGGER SETTING** soft key. The trigger condition setting menu is displayed.
10. Press the **EDGE** soft key. RISE switches to FALL, or vice versa.
11. Press the **DELAY** soft key.
12. Enter a delay time and press **ENTER**.

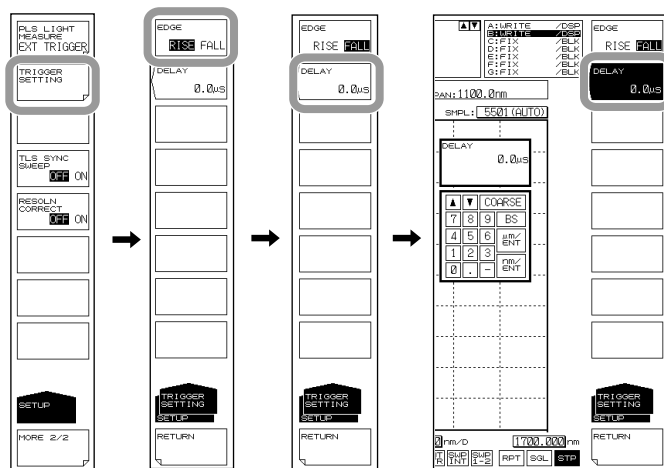

**Note**

When AVERAGE TIMES is set, sweeping stops when a number of external signals equaling the specified sampling points times the "average times" is input.

**Explanation**

Data measurement or signal sweeping starts when triggered by an external signal. An external trigger input terminal is located on the rear panel of the instrument. Input signals are of TTL levels.

**SMPL TRIG:** Measurement starts per external trigger signals. You can set whether the trigger activates on a rising or falling edge of the signal. Measurement starts approximately 70  $\mu\text{s}$  after the trigger activates.

**SWEEP TRIG:** Sweeping starts per external trigger signals. The trigger activates on the rising/falling edge of the signal. Sweeping starts 5 ms at most after the trigger activates.

**Signal Logic and Delay Time (for SMPL TRIG)****EDGE**

This key is used to set the external trigger signal detection edges.

**RISE** The rising edge is recognized as a trigger.

**FALL** The falling edge is recognized as a trigger.

**DELAY \*\*\*\*.\* $\mu\text{s}$** 

This key is used to set the delay time between trigger signal edge detection and data measurement. The setting range is 0 to 1000.0  $\mu\text{s}$  (fine: steps of 0.1; coarse: steps of 1).

For information about the external trigger measurement function, see section 2.2.

**Measurement Sensitivity and Corresponding Pulse Width**

The measurement sensitivity is determined based on the light pulse width. Select the appropriate sensitivity level based on the pulse width in the table below.

**Sensitivity Name and Corresponding Pulse Width**

Sensitivity setting	CHOP MODE	On-Screen Notation			Corresponding Pulse Width (Min.)
		Normal	PEAK HOLD Setting	EXT TIRG Setting	
NORM/HOLD	OFF	NORM/HOLD	P-NORM/HLD	E-NORM/HLD	PEAK: 100 $\mu\text{s}$ EXT: 50 $\mu\text{s}$
NORM/AUTO		NORM/AUTO	P-NORM/AUT	E-NORM/AUT	300 $\mu\text{s}$
NORMAL		NORMAL	P-NORMAL	E-NORMAL	1ms
MID		MID	P-MID	E-MID	3ms
HIGH1		HIGH1	P-HIGH1	E-HIGH1	10ms
HIGH2		HIGH2	P-HIGH2	E-HIGH2	50ms
HIGH3		HIGH3	P-HIGH3	E-HIGH3	200ms
HIGH1	CHOP	HI1/CHOP	P-HI1/CHOP	E-HI1/CHOP	50ms
HIGH2		HI2/CHOP	P-HI2/CHOP	E-HI2/CHOP	200ms
HIGH3		HI3/CHOP	P-HI3/CHOP	E-HI3/CHOP	2000ms
MID	SWITCH	MID/SW	P-MID/SW	E-MID/SW	3ms
HIGH1		HI1/SW	P-HI1/SW	E-HI1/SW	10ms
HIGH2		HI2/SW	P-HI2/SW	E-HI2/SW	50ms
HIGH3		HI3/SW	P-HI3/SW	E-HI3/SW	200ms

## 5.16 Trigger Output

### Procedure

#### Setting the Trigger Output Mode

1. Press **SYSTEM**. The soft key menu for the system settings appears.
2. Press the **MORE** soft key. The **MORE 2/4** soft key menu is displayed.
3. Press the **TRIG OUTPUT MODE** soft key. The trigger output setting menu is displayed.
4. Press the **SWEEP STATUS** soft key.

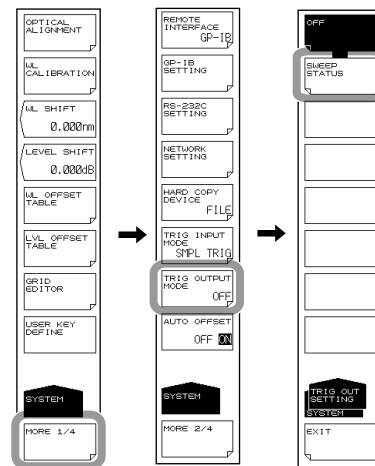

#### Note

- When synchronous sweep measurement is specified, the TRIG OUTPUT MODE soft key is disabled. To enable it, turn TLS SYNC SWEEP OFF. For the procedure, see section 5.17, "Synchronous Sweep Measurement with a Turnable Laser Source."
- When pulse light measurement is specified, external trigger output cannot be performed. Turn OFF PLS LIGHT MEASURE.

### Explanation

You can synchronize sweeping from the trigger output terminal on the rear panel of the instrument and output a positive logic signal. Signals are only output when sweeping. Output signals are of TTL levels.

## 5.17 Synchronous Sweep Measurement with the Tunable Laser Source

### Procedure

#### Connecting to the Tunable Laser Source

Before turning on the power supply, make the following connections.

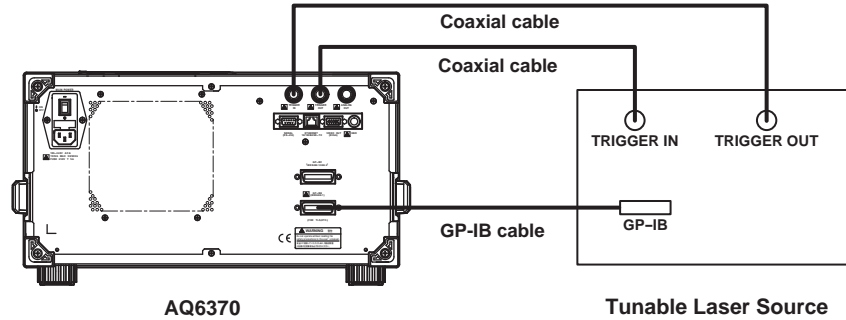

#### Connecting the Turnable Laser Source When Using the AQ4321 Series

1. Connect the GP-IB2 connector of the instrument and the GP-IB connector of the AQ4321A/D using the GP-IB cable.
2. Connect the TRIG IN terminal of the instrument and the SMPL TRIG OUT terminal of the AQ4321A/D using a coaxial cable.
3. Connect the TRIG OUT terminal of the instrument and the OSA SYNC IN terminal of the AQ4321A/D using a coaxial cable.

#### Connecting the Turnable Laser Source When Using the AQ2200-136

1. Connect the GP-IB2 connector of the instrument and the GP-IB connector of the AQ2201/2202 mainframe using the GP-IB cable.
2. Connect the TRIG IN terminal of the instrument and the SMPL TRIG OUT terminal of the AQ2201/2202 mainframe using a coaxial cable.
3. Connect the TRIG OUT terminal of the instrument and the TRIGGER IN terminal of the AQ2201/2202 mainframe using a coaxial cable.

### Setting the GP-IB Address of the Turnable Laser Source

4. Press **SYSTEM**.
5. Press the **MORE** soft key. The **MORE 2/4** soft key menu is displayed.
6. Press the **GP-IB SETTING** soft key.
7. Press the **TLS ADDRESS** soft key. The address setting screen is displayed.
8. Enter the GP-IB address of the turnable laser source connected to the instrument using the rotary knob, arrow keys, or numeric key pad.
9. Enter a numerical value, then press **ENTER**.

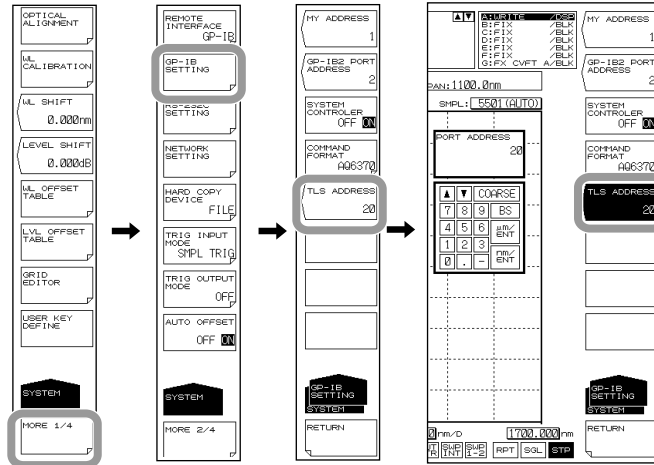

## Setting the GP-IB2 Port Address

10. Press the **GP-IB2 PORT ADDRESS** soft key. The address setting screen is displayed.
11. Enter the instrument's GP-IB2 port address using the rotary knob, arrow keys, or numeric key pad.
12. Enter a numerical value, then press **ENTER**.

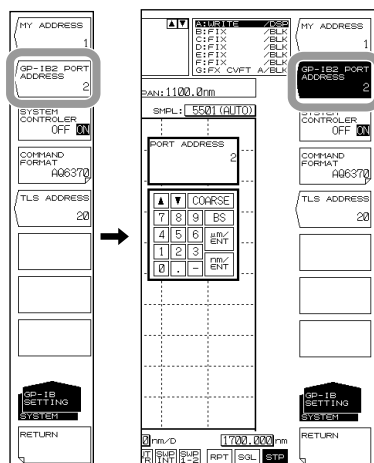

### Note

- PULSE LIGHT MEASURE and TRIGGER SETTING cannot be set.
- When performing TLS synchronous sweep, sample trigger, sweep trigger, and sweep status output (trigger output) cannot be performed.
- Make sure that the GP-IB2 port address is not the same as that of the tunable laser source.
- The GP-IB address of the tunable laser source is set to 24 (AQ4321 series) or 20 (AQ2201/2202) when shipped out from the factory. The initial GP-IB2 port address is 2.

**Executing Synchronous Sweep**

13. Confirm that the **SYSTEM CONTROLLER** soft key in the soft key menu in step 7 is turned ON.
14. Press **SETUP**.
15. Press the **MORE1/2** soft key.
16. Press the **TLS SYNC SWEEP** soft key. It turns ON.
17. Press the **SWEEP** key.
18. Press the **REPEAT** or **SINGLE** soft key. The turnable laser source's wavelength sweeps in conjunction with the instrument.

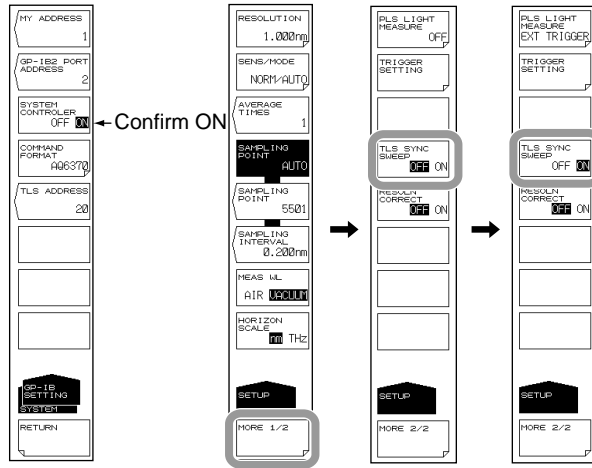

**Note**

- The resolution setting for the function is fixed to 2 nm.
- Wavelength mode is set to vacuum wavelength mode.
- make sure that the span does not exceed the turnable width of the turnable laser source.
- Set the output power and line width of the tunable laser source in advance.
- Synchronous sweeping cannot be performed in pulse light measurement mode while “AUTO” measurement is being performed.

**Explanation**

Sweeping is synchronized with the turnable laser source using trigger signals output from the instrument.

The resolution of actual measurements is determined by the sampling interval (the quotient of the “sweep width” and the “number of samples – 1”) when performing the measurement, since the resolution setting for the instrument merely determines how far to suppress the noise light output from the tunable laser source, setting a wider resolution will not influence the actual measurement resolution.

Level fluctuations of around 0.1 dB may occur when you perform synchronous sweeping with the tunable laser source set to WIDE mode.

## 5.18 Analog Out

### Procedure

#### Connecting to the Oscilloscope

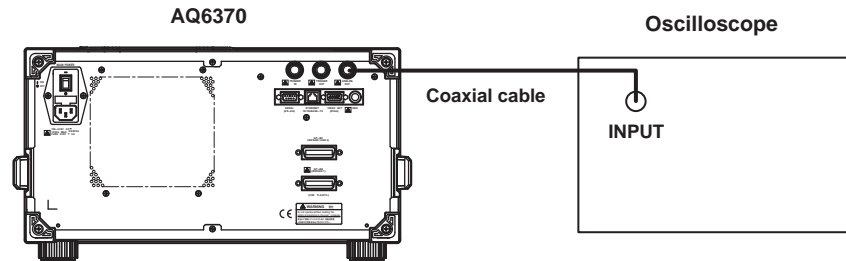

1. Press **SETUP**. The soft key menu for sweep condition settings appears.
2. Press the **SENS/MODE** soft key. Seven sensitivity choices appear in the soft key menu.
3. Press the **NORM/HOLD** soft key. The screen returns to the previous stage, and NORM/HOLD is displayed for the **SENS/MODE** soft key.
4. Press **SWEEP**. The soft key menu for sweep appears.
5. Press the **SINGLE** or **REPEAT** soft key. An analog voltage is output corresponding to the input light.

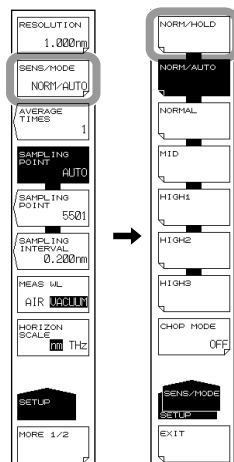

#### Note

- The analog out function is enabled only when the sensitivity is set to NORM/HOLD.
- If the level of the input light is high, the output voltage level is saturated.

## 5.18 Analog Output

---

### Explanation

The saturation level and noise level varies depending on the REF level.  
The table below shows the relationship between the REF level and the saturation level.

REF LEVEL(dBm or dBm/nm)	Saturation Level * (dBm)
REF > 0	23 dBm or more
0 <= REF > -10	13 dBm or more
-10 <= REF > -20	3 dBm or more
-20 <= REF > -30	-7 dBm or more
-30 <= REF	-17 dBm or more

\* At wavelength 1450 to 1620 nm

### ANALOG OUT Output Specifications

Output saturation voltage	+6 V or more
Offset voltage (including noise)	±5 mVp-p
Bandwidth	10 kHz or more
Load	1 kΩ or more

# 6.1 Zooming In/Out on Waveforms

## Procedure

The following are three ways of zooming in and out on waveforms.

- By specifying a center wavelength and display sweep
- By specifying a start and stop wavelength
- By zooming in/out on a range specified with the mouse

The following explains the procedure for each of these methods.

### Zooming In/Out by Specifying a Center Wavelength and Display Sweep

1. Press **ZOOM**. The soft key menu for settings related to zooming in/out on a measured waveform appears.

#### When Setting the Peak Wavelength of the Displayed Waveform as the Center Wavelength for Zooming

2. Press the **PEAK ZOOM CTR** soft key. The peak wavelength is set as the zoom center wavelength. Proceed to step 6.
3. Press the **ZOOM CENTER WL** soft key. The zoom center wavelength setting screen is displayed.
4. Enter a zoom center wavelength using the rotary knob, arrow keys, or numeric key pad.
5. Press **nm/ENTER**.
6. Press the **ZOOM SPAN WL** soft key. A screen for specifying the display sweep width (the range to zoom in/out on) is displayed.
7. Enter a display sweep width using the rotary knob, arrow keys, or numeric key pad.
8. Press **nm/ENTER**.

#### Restores the zoomed waveform to its original size

9. Press the **INITIAL** soft key.

Waveform display example

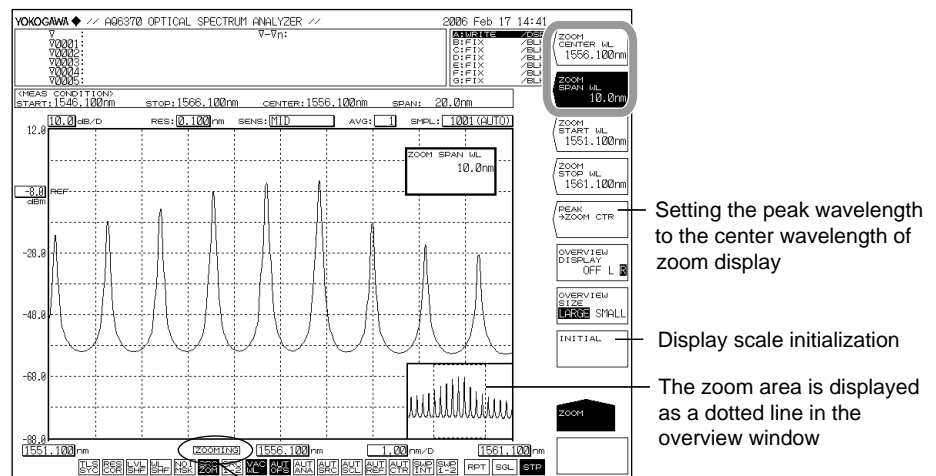

After changing the display scale (zooming), **ZOOMING** is displayed

## 6.1 Zooming In/Out on Waveforms

### Note

- It is not necessary to press nm/ENTER when using the rotary knob or arrow keys.
- If a value outside the setting range is entered, the nearest permitted value is set.

### Zooming In/Out by Specifying a Start and Stop Wavelength

1. Press **ZOOM**. The soft key menu for settings related to zooming in/out on a measured waveform appears.
2. Press the **ZOOM START WL** soft key. A screen for specifying the zoom start wavelength is displayed.
3. Enter a zoom start wavelength using the rotary knob, arrow keys, or numeric key pad.
4. Press **nm/ENTER**.
5. Press the **ZOOM STOP WL** soft key. A screen for specifying the zoom stop wavelength is displayed.
6. Enter a zoom stop wavelength using the rotary knob, arrow keys, or numeric key pad.
7. Press **nm/ENTER**.

Waveform display example

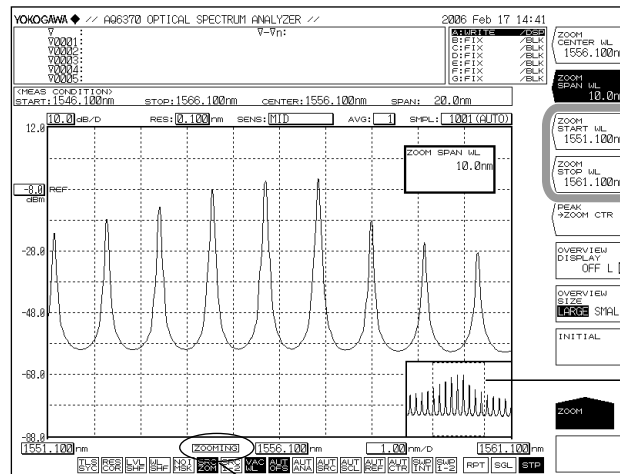

The zoom area is displayed as a dotted line in the overview window

After changing the display scale (zooming), **ZOOMING** is displayed

### Note

- It is not necessary to press nm/ENTER when using the rotary knob or arrow keys.
- If a value outside the setting range is entered, the nearest permitted value is set.

## Zooming In/Out on a Range Specified with the Mouse

1. In the waveform display area, drag the portion of the waveform to zoom in/out on. A dotted outline is displayed around the selected range. (The zoom area.)
2. When you release the left mouse button, the display zooms in on the zoom area. At the same time, the zoom area is indicated with a dotted line range in the overview window.

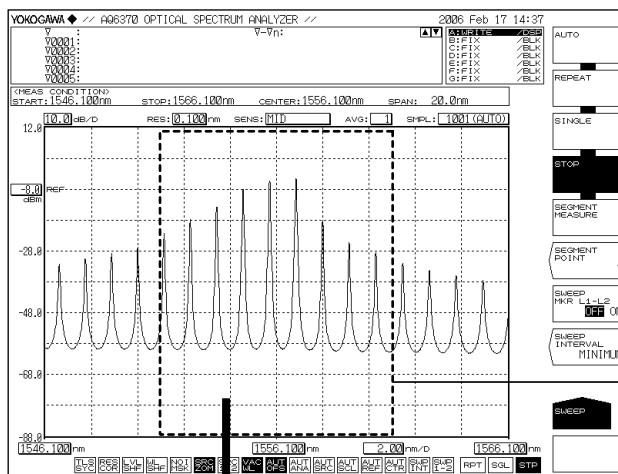

Drag the mouse in the waveform display area to set the zoom area

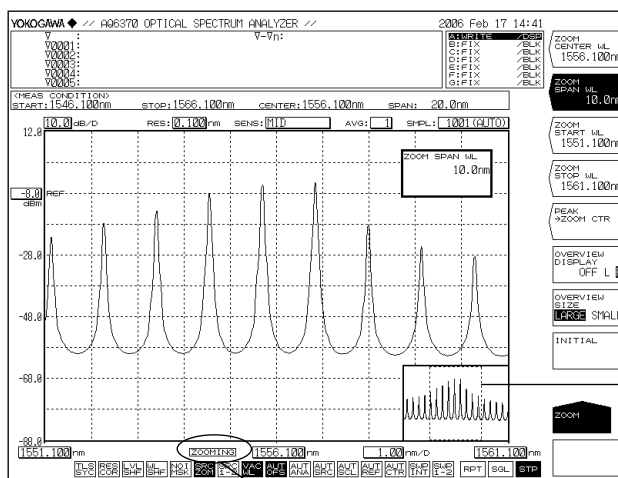

The zoom area is displayed as a dotted line in the overview window

After changing the display scale (zooming), **ZOOMING** is displayed

### Note

- If you change the display scale to a value different from the measurement scale, ZOOMING appears on screen. Also, an overview window that shows the measurement scale is displayed in the corner of the measurement screen.
- The display scale and measurement scale are mutually independent.
- Changing the zoom function settings does not change the measurement conditions.

### Setting Up the Overview Window

When the waveform display is enlarged or reduced using the zoom function, the overview window is displayed at the very bottom of the waveform display area. (Only displayed when a zoom is performed.)

### Showing/Hiding the Window and Setting the Display Position

1. Press **ZOOM**.
2. Press the **OVERVIEW DISPLAY OFF/L/R** soft key. Each time the soft key is pressed, the setting changes in the order Hide, Display Left, and Display Right.

### Setting the Window Size

1. Press **ZOOM**.
2. Press the **OVERVIEW SIZE LARGE/SMALL** soft key. The window switches between large and small.

Waveform display example

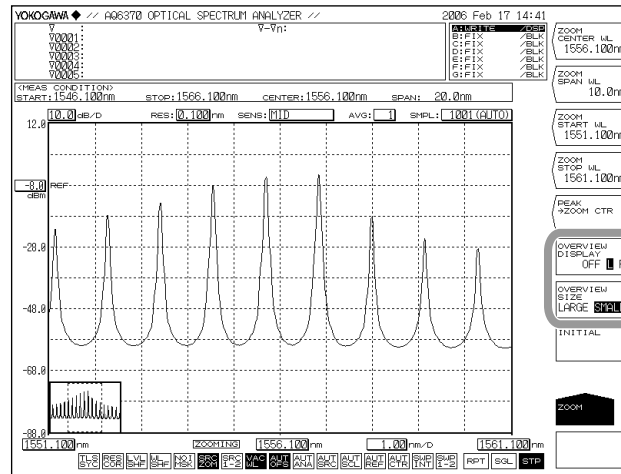

**OVERVIEW DISPLAY OFF/L/R** set to L and **OVERVIEW SIZE LARGE/SMALL** set to SMALL.

## Changing Settings Using the Mouse

The mouse can be used in the overview window to change the display scale settings.

### Changing the Center Wavelength (Center Frequency)

1. Move the mouse pointer into the overview window.
2. Drag in the zoom area surrounded by a dotted line.  
When doing so, the mouse pointer changes to a hand tool.

### Changing the Zoom Start/Stop Wavelength

1. Move the mouse pointer into the overview window.
2. Drag a vertical dotted line of the zoom area.  
When doing so, the mouse pointer changes to an arrow.

### Specifying a New Zoom Area

1. Move the mouse pointer into the overview window.
2. Drag outside of the zoom area. A new zoom area is created.  
When doing so, the mouse pointer changes to a plus (+) sign.

#### **Note**

---

For information on power measurement inside the zoom area, see section 7.4, "Power Measurement."

---

**Explanation**

**Zoom Center Wavelength**

The setting range is 600.000 to 1700.000 nm.  
If you press the COARSE key you can use the rotary knob or arrow keys to change the numerical value in 1 nm steps. The value changes in 0.1 nm steps if you do not press the COARSE key.

**Wavelength Display Sweep Width**

The available setting range is 0, and 0.1 to 1100.0 nm.  
If you press the COARSE key you can use the rotary knob or arrow keys to change the numerical value in 1-2-5 steps. The value changes in 1 nm steps if you do not press the COARSE key.

**Zoom Start Wavelength**

The setting range is 50,000 to 1699.950 nm.  
If you press the COARSE key you can use the rotary knob or arrow keys to change the numerical value in 1 nm steps. If you do not press it, the value changes in 0.1 nm steps.

**Zoom Stop Wavelength**

The setting range is 600.050 to 2250.000 nm.  
The value changes in 1 nm steps if you press the COARSE key. If you do not press it, the value changes in 0.1 nm steps.

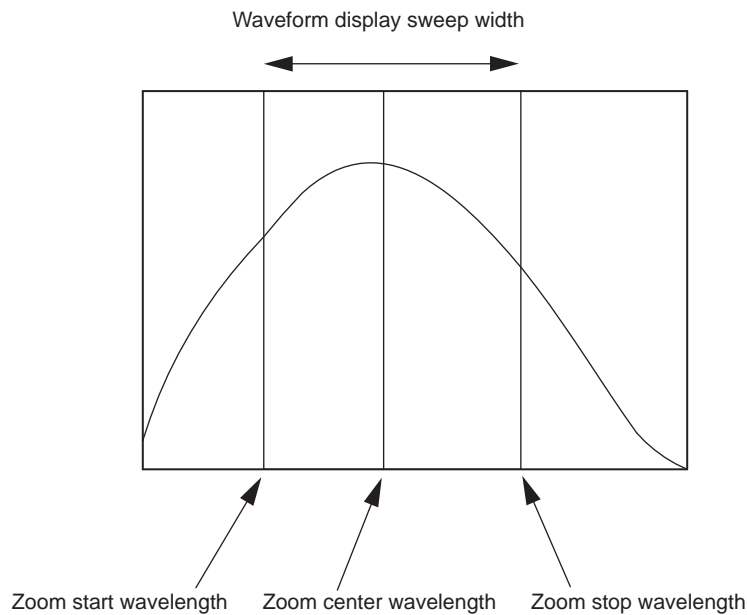

**Note**

- Changing the zoom center wavelength changes the zoom start wavelength and zoom stop wavelength. The waveform display sweep width does not change.
  - Changing the wavelength display sweep width changes the zoom start wavelength and zoom stop wavelength. The zoom center wavelength does not change.
  - When the zoom start or stop wavelength is set, one wavelength becomes fixed, and this changes the value of the wavelength display sweep width. In addition, the zoom center wavelength value is also changed at the same time.
-

### Zoom Center Frequency

The setting range is 176.5000 to 500.0000 THz.

If you press the COARSE key you can use the rotary knob or arrow keys to change the numerical value in 0.1 THz steps. The value changes in 0.01 THz steps if you do not press the COARSE key.

### Frequency Display Sweep Width

The allowed settings are 0 and the range of 0.01 to 330.000 THz.

If you press the COARSE key you can use the rotary knob or arrow keys to change the numerical value in 1-2-5 steps. The value changes in 0.1 THz steps if you do not press the COARSE key.

### Zoom Start Frequency

The setting range is 11.5000 to 499.9950 THz.

If you press the COARSE key you can use the rotary knob or arrow keys to change the numerical value in 0.1 THz steps. The value changes in 0.01 THz steps if you do not press the COARSE key.

### Zoom Stop Frequency

The setting range is 176.5050 to 665.0000 THz.

The value changes in 0.1 THz steps if you press the COARSE key. If you do not press it, the value changes in 0.01 THz steps.

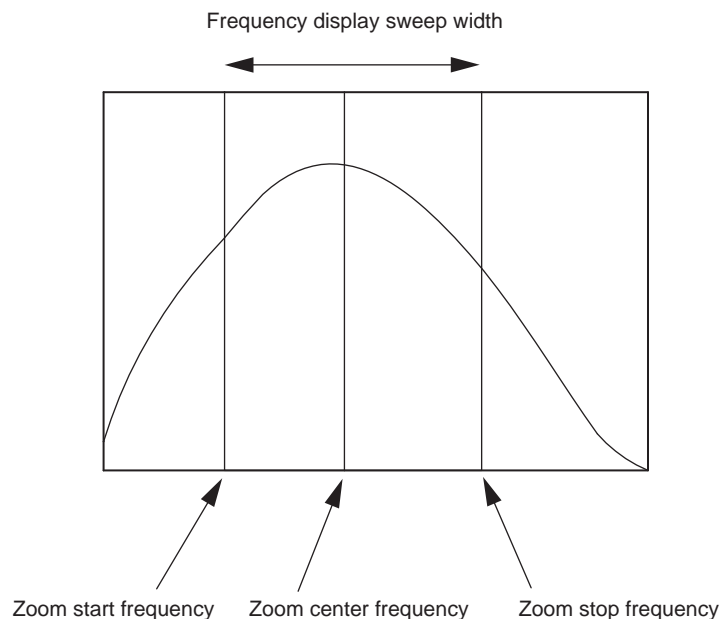

#### Note

- Changing the zoom center frequency changes the zoom start frequency and zoom stop frequency. The frequency display sweep width does not change.
- Changing the frequency display sweep width changes the zoom start frequency and zoom stop frequency. The zoom center frequency does not change.
- When the zoom start or stop frequency is set, one frequency becomes fixed, and this changes the value of the frequency display sweep width. In addition, the zoom center frequency value is also changed at the same time.

## 6.2 Wavelength Updating/Fixing

### Procedure

#### Selecting a Trace to Update or Fix

1. Press **TRACE**. The soft key menu for trace settings appears.
2. Press the **ACTIVE TRACE** soft key. Traces A through G appear in soft keys.
3. Press the soft key corresponding to the trace you wish to update or fix. The selected trace is set as the active trace, and becomes the target of the operation below.
4. Press the **VIEW** soft key of the selected trace and select **DISP**. Each time you press the soft key **DISP** switches to **BLANK**, or viceversa. (Trace B is given as an example.)

#### Updating a Waveform

5. Press the **WRITE** soft key. The trace area display switches to WRITE.
6. Perform measurement. The wavelength data is updated.

#### Fixing a Waveform

5. Press the **FIX** soft key. The trace area display switches to FIX.
6. The waveform data is fixed. Even if measurement is performed, the waveform data is not updated.

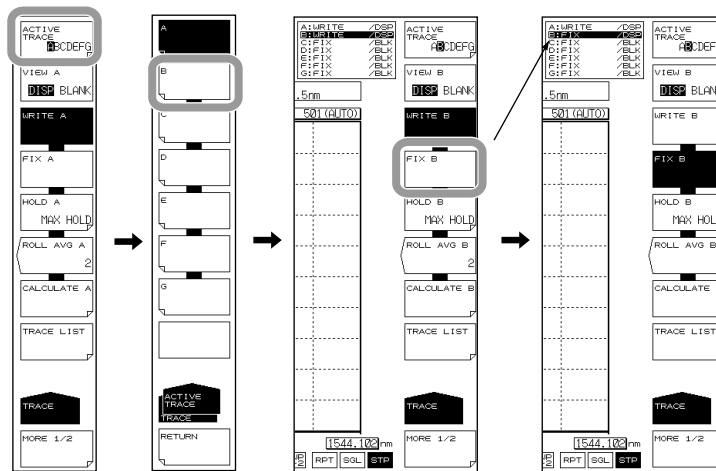

#### Note

- Only 1 trace can be set as the active waveform. If you wish to update multiple traces, update them one at a time.
- If all traces are set to FIX, a warning appears, and measurement cannot be performed.

For information on the trace function, see section 2.3

**Explanation****Active Trace**

Active trace refers to a target trace to which settings and changes can be applied. A trace shows a waveform and measurement conditions. The instrument has a total of seven independent traces (A through G). You can specify Show/Hide on each trace, and display multiple traces in the waveform screen. The following explains the soft keys related to trace settings.

**ACTIVE TRACE...ABCDEFG**

Selects the active trace from among traces A to G. You can also switch the active trace using the mouse by clicking TRACE display A through G on the screen.

**Displaying Traces**

Selects whether or not to display the active trace on screen.

**VIEW @...DISP / BLANK**

"VIEW @ DISP": Displays the waveform on the screen. The trace display changes to "DSP".

"VIEW @ BLANK": Does not display the waveform on the screen. The trace display changes to "BLK".

When you press this key, the highlight toggles between "VIEW @ DISP" and "VIEW @ BLANK".

Note that if BLANK is set, markers applied to the trace set in DISP will be cleared. The "at" (@) symbol indicates the currently selected trace. One is included from A–G.

**Write Mode****WRITE @**

This key is used to set the active trace to write mode.

When a trace is set to write mode, waveform data are written to it and updated during measurement. In addition, the trace display on the side of the data area changes to "WRITE".

The "at" (@) symbol indicates the currently selected trace. One is included from A–G.

**Fixed mode****FIX @**

This key is used to set the active trace to data fixing mode.

When a trace is set to this mode, its waveform data do not change even when measurement is performed. Therefore, the waveform on the screen is not overwritten. The trace display changes to "FIX".

When the FIX soft key is pressed during sweeping, the waveform displayed at that time is fixed.

The "at" (@) symbol indicates the currently selected trace. One is included from A–G.

## 6.3 MAX/MIN HOLD Display

### Procedure

#### Selecting a Trace to Hold

1. Press **TRACE**. The soft key menu for trace settings appears.
2. Press the **ACTIVE TRACE** soft key. Traces A through G appear in soft keys.
3. Press the soft key corresponding to the trace whose maximum or minimum value you wish to hold. The selected trace is set as the active trace, and becomes the target of the operation below.
4. Press the **VIEW** soft key of the selected trace and select **DISP**. Each time you press the soft key **DISP** switches to **BLANK**, or vice versa. (Trace B is given as an example.)

#### Holding the Maximum/Minimum Value

5. Press the **HOLD** soft key. The soft key menu for selecting MAX/MIN appears.
6. To hold the maximum value press the **MAX HOLD** soft key.  
To hold the minimum value press the **MIN HOLD** soft key.  
The maximum or minimum value is held.
7. Perform measurement.

If you selected **MAX HOLD** and the measured value is larger than the previous value, waveform data is updated.

If you selected **MIN HOLD** and the measured value is smaller than the previous value, waveform data is updated.

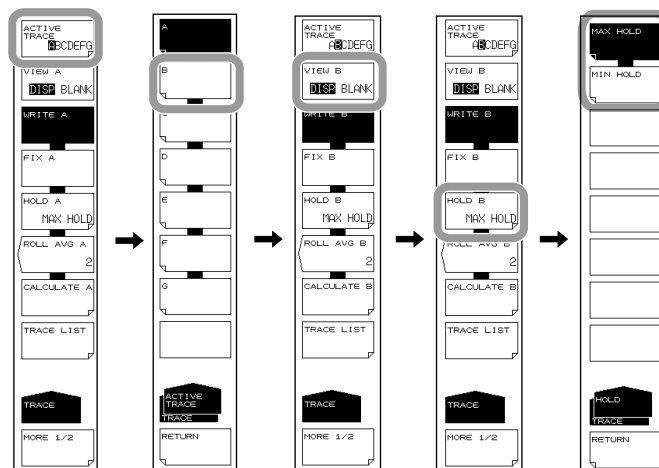

#### Note

MAX/MIN HOLD is only enabled when the sweep mode is REPEAT. It does not function even if you perform repeated SINGLE sweeps.

## 6.4 Sweep Average

### Procedure

#### Selecting a Trace to Average

1. Press **TRACE**. The soft key menu for trace settings appears.
2. Press the **ACTIVE TRACE** soft key. Traces A through G appear in soft keys.
3. Press the soft key corresponding to the trace you wish to average. The selected trace is set as the active trace, and becomes the target of the operation below.
4. Press the **VIEW** soft key of the selected trace and select **DISP**. Each time you press the soft key **DISP** switches to **BLANK**, or viceversa. (Trace B is given as an example.)

#### Setting the Averaging Times

5. Press the **ROLL AVE** soft key. The averaging times dialog box is displayed.
6. Enter a number of averaging times using the rotary knob, step keys, or numeric key pad.
7. Perform measurement. The sweep average value is updated each time measurement is performed.

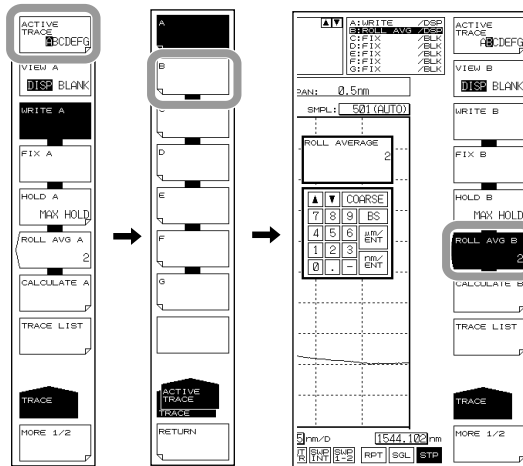

#### note

The allowed setting for averaging times is 2-100.

## 6.4 Sweep Average

---

### Explanation

When a trace is set to ROLL AVG mode, each time measurement is performed the sweep average is taken of the current and past measured data, and the measurement data are updated.

The roll averaging is calculated according to the following equation.

$$W_j(i) = W_{j-1}(i) \cdot (n - 1) / n + W(i) \cdot 1 / n \quad (i=1, 2, \dots, N)$$

$W_j(i)$ : Newly displayed waveform

$W_{j-1}(i)$ : Previously displayed waveform

$W(i)$ : Newly obtained waveform

$N$ : Number of sampling points

$n$ : Number of averagings

### Note

---

- The setting values of the NOISE MASK function are not affected by sweep averaging. The noise mask is executed when the results of the sweep average are displayed.
  - When CHOP MODE in the measurement sensitivity settings is set to SWITCH, two sweepings is one count.
-

## 6.5 Displaying Calculated Waveforms

### Procedure

#### Selecting Traces for Calculation

1. Press **TRACE**. The soft key menu for trace settings appears.
2. Press the **ACTIVE TRACE** soft key. Traces A through G appear in soft keys.
3. Press the soft key corresponding to a trace that is available for trace-to-trace calculation (C, F, or G).

The calculated results are displayed in the selected trace.

The items that can be calculated differ depending on the trace selected.

4. Press the **VIEW** soft key of the selected trace and select **DISP**. Each time you press the soft key **DISP** switches to **BLANK**, or viceversa.

#### Selecting a Calculation

5. Press the **CALCULATE** soft key. The LOG and Linear selection menus are displayed.
6. For log calculations, press the **LOG MATH** soft key. For linear calculations, press the **LIN MATH** soft key. The soft key menu showing the choices for calculation appears.
7. Press the soft key corresponding to the desired calculation. The calculation executes.

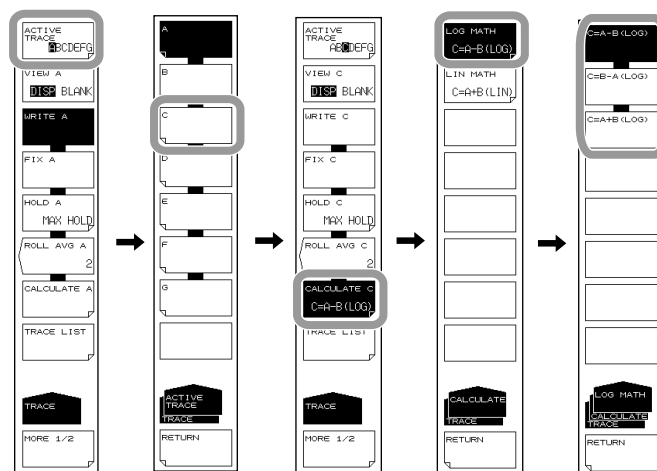

#### Note

- Trace-to-trace calculations can only be performed on C, F, or G. If the active trace is set to something other than trace C, F, or G, the CALCULATE key is disabled.
- If a trace targeted for calculation is remeasured and the center wavelength and measurement span of the trace being measured is changed, it is recalculated and redisplayed.
- If the measurement condition (resolution) of the trace targeted for calculation does not match, a warning is displayed after calculation.

**Explanation****Executable Trace-to-Trace Calculations****Trace C**

LOG calculations: A-B, B-A, A+B

Linear calculations: A+B, B-A, A-B, 1-k(A/B), 1-k(B/A)

**Trace F**

LOG calculations: C-D, D-C, C+D, D-E, E-D, D+E

Linear calculations: C+D, C-D, D-C, D+E, D-E, E-D

**Trace G**

LOG calculations: C-F, F-C, C+F, E-F, F-E, E+F

Linear calculations: C+F, C-F, F-C, E+F, E-F, F-E

NORMALIZE (A, B, C)

CURVE FIT (A, B, C)

PEAK CURVE FIT (A, B, C)

MARKER FIT

Calculation results are written to their corresponding traces.

**Details of Calculation**

The following are explanations given for traces C, F, and G.

**Trace C: CALCULATE C****LOG MATH**

This key is used to perform LOG calculations on trace-to-trace data and write the results to trace C. Calculations can be applied to trace A and trace B. If both traces selected for calculation are set to "BLANK", then the sub-scale is displayed on the left side of the screen. Otherwise it is displayed on the right side. The calculation results are displayed in the sub-scale.

C=A-B(LOG) Subtracts trace B from trace A in LOG form.

C=B-A(LOG) Subtracts trace A from trace B in LOG form.

C=A+B(LOG) Adds trace A and trace B in LOG form.

**LIN MATH**

This key is used to perform linear calculations on trace-to-trace data and write the results to trace F. Calculations can be applied to trace A and trace B. The calculation results are displayed in the main scale.

C=A+B(LIN) Adds trace A and trace B in linear form.

C=A-B(LIN) Subtracts trace B from trace A in linear form.

C=B-A(LIN) Subtracts trace A from trace B in linear form.

C=1-k(A/B) Given Trace A and Trace B, calculates 1-k(A/B).

Calculates  $1-k \times (\text{trace A}/\text{Trace B})$  (linear value), and writes the results to trace C. The coefficient k may be changed in the range of 1.0000 to 20000.0000 (in steps of 0.0001) using the rotary knob, arrow keys, or numeric keypad.

The coefficient k setting applies to both the <C=1-k(A/B)> key and <C=1-k(B/A)> key. The trace display on the side of the data area changes to "1-k(A/B)".

C=1-k(B/A) Given Trace A and Trace B, calculates 1-k(B/A).

Calculates  $1-k \times (\text{Trace B}/\text{Trace A})$  (linear value), and writes the results to trace C. The trace display on the side of the data area changes to "1-k(B/A)".

### Example of Specific Usage

As shown below, this  $\langle 1-kA/B \rightarrow C \text{ k=****. * } \rangle$  key or  $\langle 1-kB/A \rightarrow C \text{ k=****. * } \rangle$  key may be used to estimate the transmission efficiency from the reflection light spectrum, or estimate the reflectivity from the transmission light spectrum for DUT.

- (1) Estimating the transmission efficiency (trace C) from the reflection light spectrum (trace A)

$$\text{Transmitted light spectrum (TRACE C)} = 1 - k (\text{TRACE A} / \text{TRACE B})$$

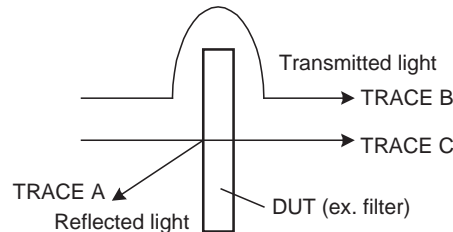

- (2) Estimating the reflectivity (trace C) from the transmission light spectrum (trace A)

$$\text{Reflected light spectrum (TRACE C)} = 1 - k (\text{TRACE A} / \text{TRACE B})$$

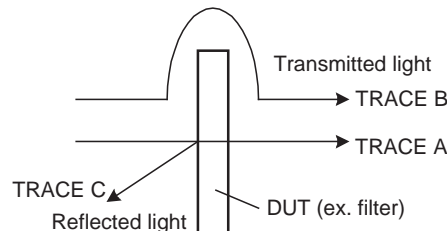

The value of  $k$  is an absorption coefficient which is used in determining the DUT reflectivity and transmission efficiency. Different algorithms are used depending on whether transmission efficiency or reflectivity is estimated, so the  $k$  value also varies accordingly.

The following equation can be used to determine “ $k_r$ ” and “ $k_t$ ”. In the equation,  $P_{in}$  is the level prior to DUT input;  $P_{out}$  is the level after DUT input;  $P_{re}$  is the DUT reflection level; “ $k_r$ ” is the absorption coefficient used to determine the reflectivity; and “ $k_t$ ” is the absorption coefficient used to determine the transmission efficiency. (Each level is a linear value.)

Estimating the reflected light spectrum from the transmission light spectrum

$$k_t = (P_{in} - P_{re}) / P_{out}$$

Estimating the transmission light spectrum from the reflected light spectrum

$$k_r = (P_{in} - P_{out}) / P_{re}$$

### Trace F: CALCULATE F

#### LOG MATH

This key is used to perform LOG calculations on trace-to-trace data and write the results to trace F. Calculations can be applied to trace C, trace D, and trace E. If both traces selected for calculation are set to "BLANK", then the sub-scale is displayed on the left side of the screen. Otherwise it is displayed on the right side. The calculation results are displayed in the sub-scale.

$F=C-D(\text{LOG})$  Subtracts trace D from trace C in LOG form.

$F=D-C(\text{LOG})$  Subtracts trace C from trace D in LOG form.

$F=C+D(\text{LOG})$  Adds trace C and trace D in LOG form.

$F=D-E(\text{LOG})$  Subtracts trace E from trace D in LOG form.

$F=E-D(\text{LOG})$  Subtracts trace D from trace E in LOG form.

$F=D+E(\text{LOG})$  Adds trace D and trace E in LOG form.

#### LIN MATH

This key is used to perform linear calculations on trace-to-trace data and write the results to trace F. Calculations can be applied to trace C, trace D, and trace E. The calculation results are displayed in the main scale.

$F=C+D(\text{LIN})$  Adds trace C and trace D in linear form.

$F=C-D(\text{LIN})$  Subtracts trace D from trace C in linear form.

$F=D-C(\text{LIN})$  Subtracts trace C from trace D in linear form.

$F=D+E(\text{LIN})$  Adds trace D and trace E in linear form.

$F=D-E(\text{LIN})$  Subtracts trace E from trace D in linear form.

$F=E-D(\text{LIN})$  Subtracts trace D from trace E in linear form.

**Trace G: CALCULATE G****LOG MATH**

This key is used to perform LOG calculations on trace-to-trace data and write the results to trace G. Calculations can be applied to trace C, trace E, and trace F. If both traces selected for calculation are set to "BLANK", then the sub-scale is displayed on the left side of the screen. Otherwise it is displayed on the right side. The calculation results are displayed in the sub-scale.

$G=C-F(\text{LOG})$  Subtracts trace F from trace C in LOG form.

$G=F-C(\text{LOG})$  Subtracts trace C from trace F in LOG form.

$G=C+F(\text{LOG})$  Adds trace C and trace F in LOG form.

$G=E-F(\text{LOG})$  Subtracts trace F from trace E in LOG form.

$G=F-E(\text{LOG})$  Subtracts trace E from trace F in LOG form.

$G=E+F(\text{LOG})$  Adds trace E and trace F in LOG form.

**LIN MATH**

This key is used to perform linear calculations on trace-to-trace data and write the results to trace G. Calculations can be applied to trace C, trace E, and trace F. The calculation results are displayed in the main scale.

$G=C+F(\text{LIN})$  Adds trace C and trace F in linear form.

$G=C-F(\text{LIN})$  Subtracts trace F from trace C in linear form.

$G=F-C(\text{LIN})$  Subtracts trace C from trace F in linear form.

$G=E+F(\text{LIN})$  Adds trace E and trace F in linear form.

$G=E-F(\text{LIN})$  Subtracts trace F from trace E in linear form.

$G=F-E(\text{LIN})$  Subtracts trace E from trace F in linear form.

**NORMALIZE**

This is one of the trace calculation modes. The trace data is normalized and displayed. The normalization results can be written to trace G and displayed. One trace can be normalized, either trace A, B, or C. The peak of a normalized waveform is 1 if the subscale is linear, or 0 dB for a LOG scale.

Data are displayed when sweeping is completed at the stop.

If both traces selected for calculation are set to "BLANK", then the sub-scale is displayed on the left side of the screen. Otherwise it is displayed on the right side. The calculation results are displayed in the sub-scale.

The trace display at the side of the data area changes to "NORM @".

$G=\text{NORM A}$  Normalizes trace A and writes the normalized data to trace G.

$G=\text{NORM B}$  Normalizes trace B and writes the normalized data to trace G.

$G=\text{NORM C}$  Normalizes trace C and writes the normalized data to trace G.

**CURVE FIT**

For more information, see section 6.7, "Curve Fit."

**PEAK CURVE FIT**

For more information, see section 6.7, "Curve Fit."

## 6.6 Normalized Display

### Procedure

1. Press **TRACE**. The soft key menu for trace settings appears.
2. Press the **ACTIVE TRACE** soft key. Traces A through G appear in soft keys.
3. Press the Trace G soft key. The Trace G setting menu is displayed.
4. Press the **VIEW G DISP/BLANK** soft key and select **DISP**. Each time you press the soft key **DISP** switches to **BLANK**, or viceversa.
5. Press the **CALCULATE G** soft key.
6. Press the **NORMALIZE** soft key.
7. To normalize Trace A press the **G=NORM A** soft key, to normalize Trace B press **G=NORM B**, and to normalize Trace G, press **G=NORM C**.

Example of waveform before normalization

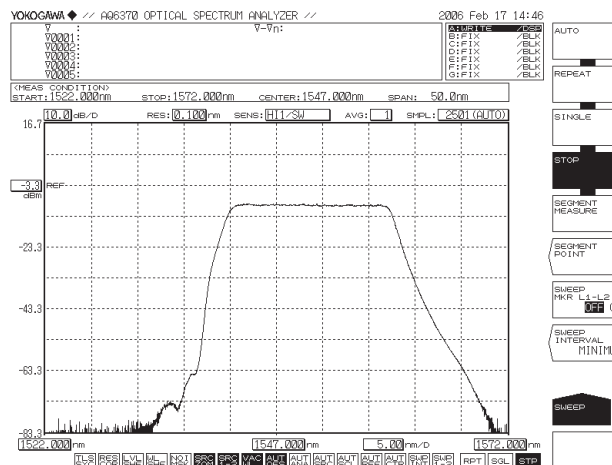

Example of waveform after normalization

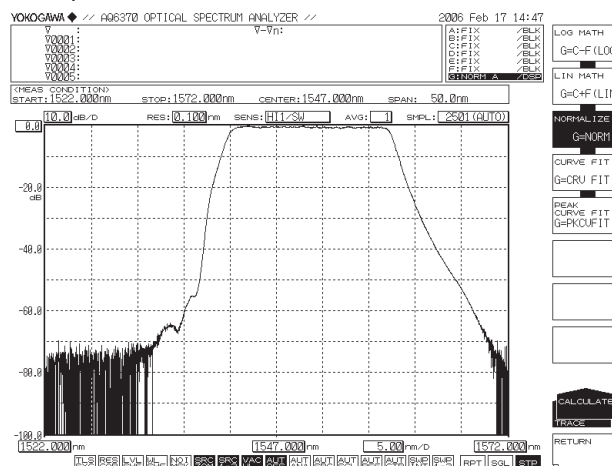

### Note

- Normalization is not possible if the waveform level is too low.
- See section 6.5 for information about NORMALIZE.

## 6.7 Curve Fitting

### Procedure

#### Setting the Target Trace

1. Press **TRACE**. The soft key menu for trace settings appears.
2. Press the **ACTIVE TRACE** soft key. Traces A through G appear in soft keys.
3. Press the Trace G soft key. The Trace G setting menu is displayed.
4. Press the **VIEW G DISP/BLANK** soft key and select **DISP**. Each time you press the soft key **DISP** switches to **BLANK**, or viceversa.
5. Press the **CALCULATE G** soft key.
6. Press the **CURVE FIT** soft key. The menu for selecting the trace to curve fit is displayed.
7. To curve fit Trace A press the **G=CRV FIT A** soft key, to curve fit Trace B press **G=CRV FIT B**, and to curve fit Trace G, press **G=CRV FIT C**.

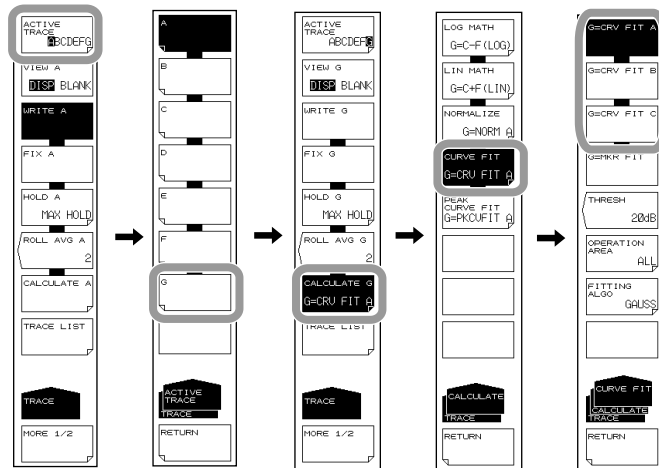

### Setting the Calculation Target Range

8. Press the **THRESH** soft key. The threshold setting screen is displayed.
9. Enter a threshold using the rotary knob, arrow keys, or numeric key pad.
10. Press **ENTER**.
11. Press the **OPERATION AREA** soft key. The calculation target range setting menu is displayed.
12. Press the soft key corresponding to the range to be set as the calculation target.

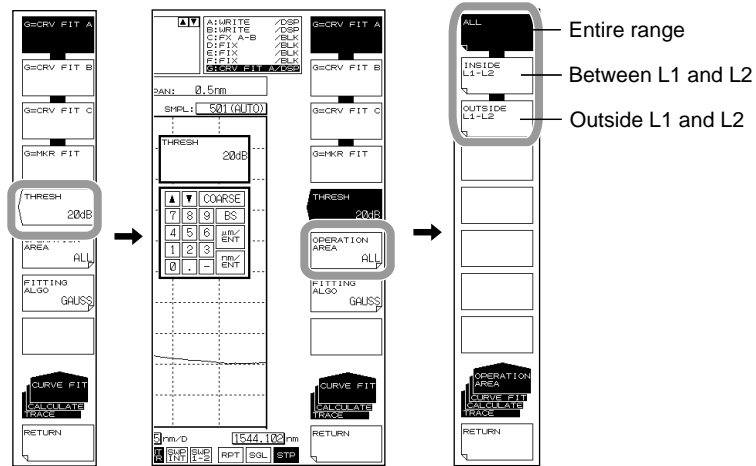

**Note**

For information about the calculation target range, see the explanation.

### Selecting the Curve Fitting Algorithm

13. Press the **FITTING ALGO** soft key. The algorithm setting menu is displayed.
14. Press the soft key corresponding to the algorithm you wish to use.

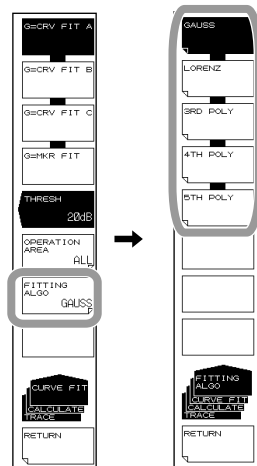

**Note**

For information about the curve fitting algorithm, see the explanation.

## Peak Curve Fit

6. Continuing on from step 5, press the **PEAK CURVE FIT** soft key.
7. To peak curve fit Trace A press the **G=PKCVFIT A** soft key, to peak curve fit Trace B press **G=PKCVFIT B**, and to peak curve fit Trace G, press **G=PKCVFIT C**. Step 8 and thereafter are the same as for curve fitting.

Example of the screen for running peak curve fitting when the curve fitting function is set to GAUSS.

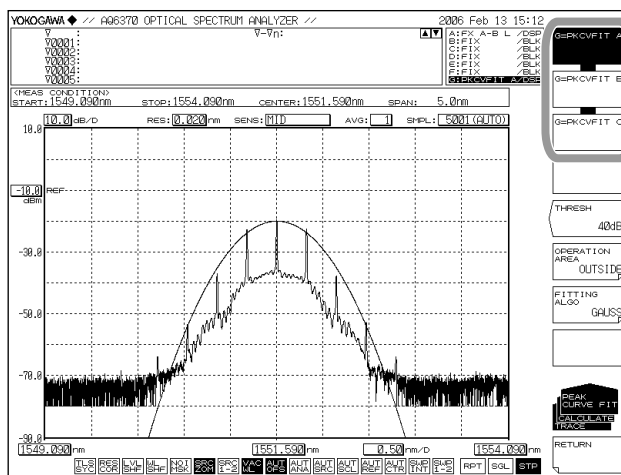

**Explanation**

**Curve Fit Target Range**

Curve-fits the specified trace waveform and writes the results to trace G.  
 Calculations are applied to data from the threshold value to the peak. The threshold value is set in the range of 0 to 99 dB (steps of 1). The trace display at the side of the data area changes to "CRV FIT @" and "MKR FIT."

**Curve Fit Target Trace**

Soft Key Display

- G=CRV FIT A    Curve-fits trace A.
- G=CRV FIT B    Curve-fits trace B.
- G=CRV FIT C    Curve-fits trace C.
- G=MKR FIT      Make the curve-fit data form markers which are set currently.  
 MKR FIT is independent on the trace.

Example of a curve-fitted waveform (data range: OUTSIDE L1-L2)

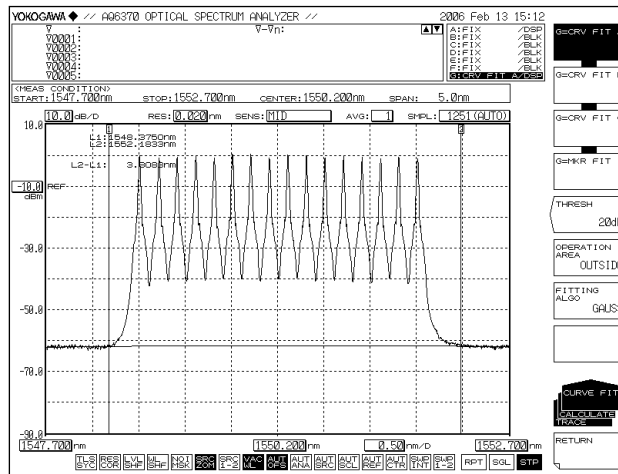

Example of a marker-fitted waveform (data range: ALL)

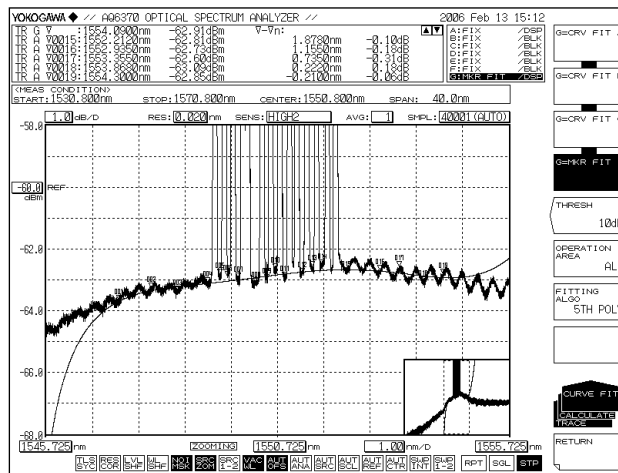

### Peak Curve Fit Target Range

Peak-curve-fits the specified trace waveform and writes the results to trace G. Calculations are applied to mode peaks at the threshold value or more. The threshold value is set in the range of 0 to 99 dB (steps of 1). The trace display at the side of the data area changes to "PKCVFIT @".

### Peak Curve Fit Target Trace

Soft Key Display

G= PKCVFIT A	Peak-curve-fits trace A.
G= PKCVFIT B	Peak-curve-fits trace B.
G= PKCVFIT C	Peak-curve-fits trace C.

## 6.7 Curve Fitting

### Range of Target Data for Calculation

Vertical axis Data from threshold value to peak.  
 The threshold value is set in the range of 0 to 99 dB (steps of 1).  
 Horizontal axis Soft key display.

ALL Targets all trace data for calculation.  
 INSIDE L1-L2 Targets the data of between line markers for calculation.  
 OUTSIDE L1-L2 Targets the data outside line markers for calculation.

OPERATION AREA when set to INSIDE L1-L2

■: OPERATION AREA

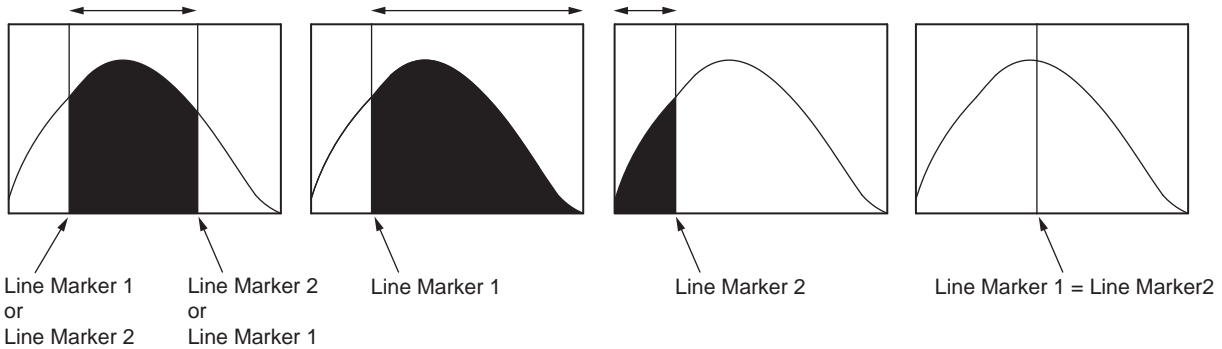

OPERATION AREA when set to OUTSIDE L1-L2

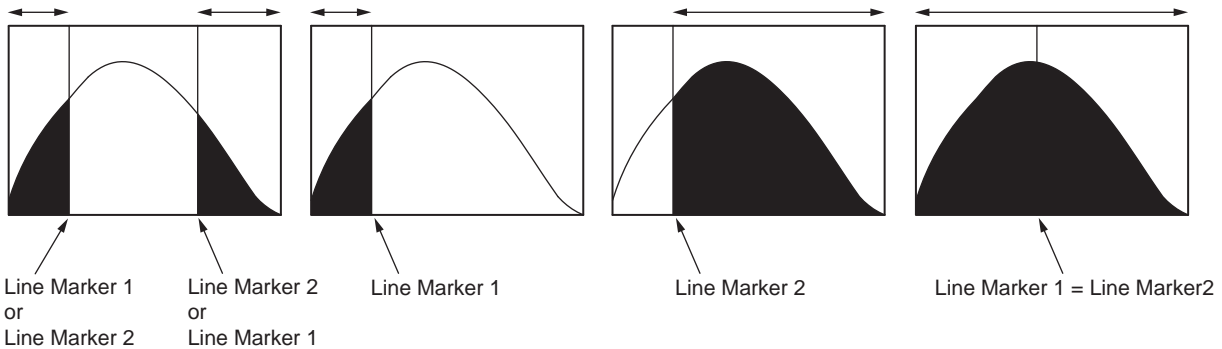

### Curve Fitting Algorithm

Soft Key Display	Description
GAUSS	Normal distribution curve
LORENZ	Lorenz curve
3RDPOLY	3rd poly
4THPOLY	4th poly
5THPOLY	5th poly

#### Note

If G=MKR FIT is selected, fitting cannot be performed if only a small number of markers are placed. A warning displays in these cases: WARNING 111: <G=MKR FIT>failed

GAUSS, LORENZ: Fewer than 3 markers

3RD POLY: Fewer than 4 markers

4TH POLY: Fewer than 5 markers

5TH POLY: Fewer than 6 markers

# 6.8 Marker Display

## Procedure

### Displaying Moving Markers

1. Press the **MARKER**. The soft key menu for marker settings appears.
2. Press the **MARKER ACTIVE OFF/ON** soft key.

### Note

- If the active trace is not set to DISP, the moving marker cannot be used. Set the trace VIEW @ DISP/BLANK soft key setting to DISP.
- Even if you press **PEAK SEARCH** the moving marker is displayed.

### Moving the Moving Markers

3. Enter a wavelength using the numeric key pad, then press **nm/ENTER**.
4. Or, refer to the following and move the moving marker.

Direction	Moving Procedure
Move to right	Turn the rotary knob to the right. Press the UP arrow key.
Move to left	Turn the rotary knob to the left. Press the DOWN arrow key.

### Placing Fixed Markers

3. With the moving marker displayed, press the **SET MARKER** soft key. The **SET** soft key and marker number screen are displayed.
4. Press the **SET** soft key. The fixed marker is placed in the position of the current moving marker. Fixed markers are automatically assigned numbers in order starting from 001.

Fixed markers of any number can be positioned. The value is entered in the DATA ENTRY section.

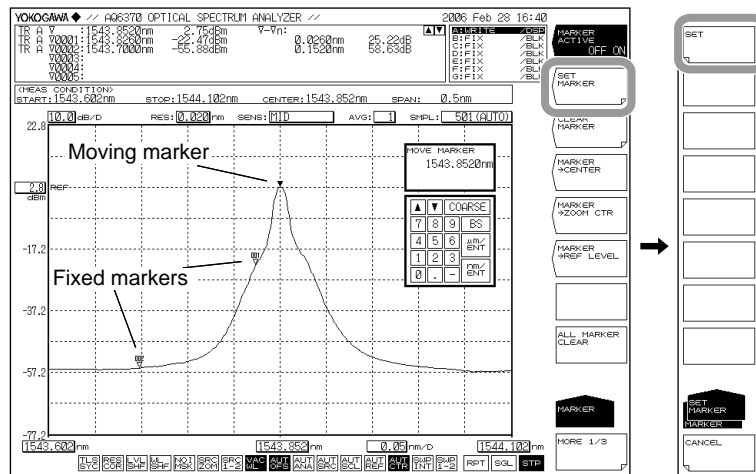

### Clearing Fixed Markers

3. Press the **CLEAR MARKER** soft key.
4. The number of the fixed marker to be cleared is entered in the DATA ENTRY section.
5. Press the **CLEAR** soft key.

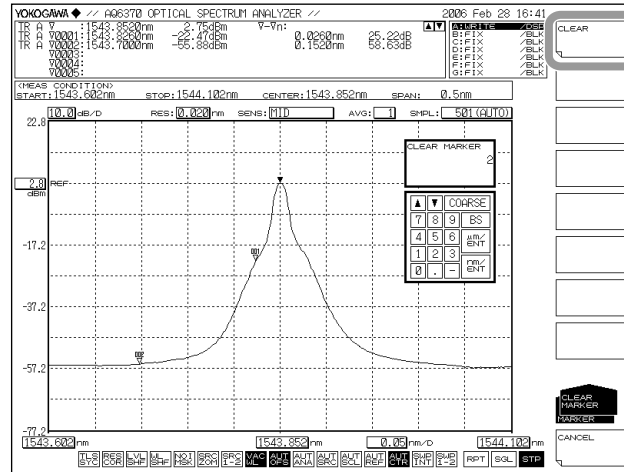

### Clearing All Markers

3. Press the **ALL MARKER CLEAR** soft key. All markers (moving markers and fixed markers) displayed on the screen are cleared. In addition, the **MARKER ACTIVE** soft key turns OFF.

## Using Moving Markers to Set the Center Wavelength to Be Measured, the Zoom Center Wavelength, and the Reference Level

### Setting the Moving Marker Wavelength as the Measurement Center Wavelength

With the moving marker displayed, press the **MARKER-> CENTER** soft key. The measured center wavelength setting screen and setting value are displayed. For information on the center wavelength, see section 5.5, "Center Wavelength Setting."

The measurement center wavelength can be set by continuing in the DATA ENTRY section.

#### Note

The **MARKER->CENTER** soft key cannot be used under the following conditions.

- When the moving marker is OFF.
- When both SPLIT screens are on HOLD.
- When the measurement data SPAN is 0 nm.

### Setting the Moving Marker Wavelength as the Zoom Center Wavelength

With the moving marker displayed, press the **MARKER-> ZOOM CTR** soft key. The zoom center wavelength setting screen and setting value are displayed. For information on the zoom center wavelength, see section 6.1, "Zooming In/Out on a Wavelength."

The zoom center wavelength can be set by continuing from the DATA ENTRY section.

#### Note

The **MARKER->ZOOM CTR** soft key cannot be used under the following conditions.

- When the moving marker is OFF.
- When both SPLIT screens are on HOLD.
- When the measurement data SPAN is 0 nm.

### Setting the Moving Marker Level to the Reference Level

With the moving marker displayed, press the **MARKER-> REF LEVEL** soft key. The reference level setting screen and setting value are displayed. For information on the reference level, see section 5.4, "Reference Level Setting." You can also rewrite the currently displayed waveform according to the modified reference level.

The measurement center wavelength can be set by continuing in the DATA ENTRY section.

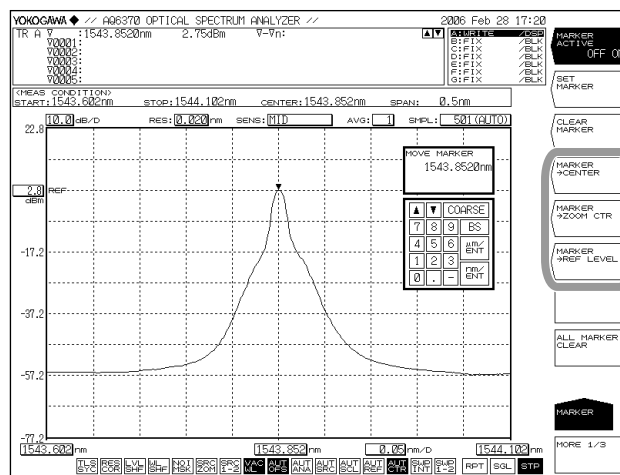

### Setting Marker Difference Value Display

You can set the difference display for markers displayed in the data area to OFFSET or SPACING.

1. Press **MARKER**.
2. Press the **MORE** soft key twice. The **MORE 3/3** key menu is displayed.
3. Press the **MARKER DISPLAY** soft key. The difference value display selection menu is displayed.
4. Press the **OFFSET** or **SPACING** soft key.

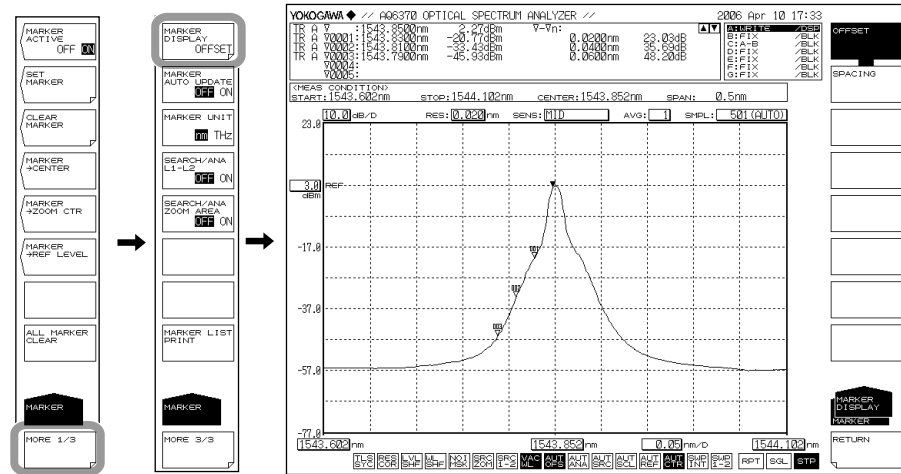

**Note**

When set to **OFFSET**, the difference between the moving marker and each fixed marker is displayed. When set to **SPACING**, the difference between the moving marker and the smallest-numbered fixed marker is displayed along with the difference from each of the fixed markers.

### Automatically Updating the Level Value of the Fixed Markers

The fixed marker's level value is updated to track the waveform each time the displayed waveform is updated.

1. Press **MARKER**.
2. Press the **MORE** soft key twice. The **MORE 3/3** key menu is displayed.
3. Press the **MARKER AUTO UPDATE OFF ON** soft key to select **ON**.

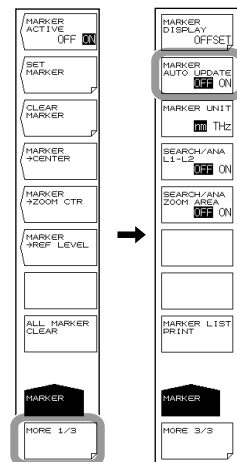

## Setting the unit for the Marker Value

1. Press **MARKER**.
2. Press the **MORE** soft key twice. The **MORE 3/3** key menu is displayed.
3. Press the **MARKER UNIT nm THz** soft key. Each time you press the soft key, the instruments toggle between nm and THz.

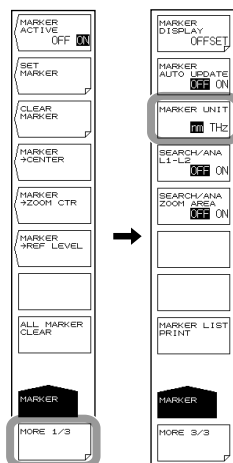

### Note

The display unit for the marker value (wavelength or frequency) can be set independently of the waveform display's horizontal axis units (wavelength or frequency) that were specified using the HORIZON SCALE nm/THz soft key.

## Printing Out Marker Values

1. Press **MARKER**.
2. Press the **MORE** soft key twice. The **MORE 3/3** key menu is displayed.
3. Press the **MARKER LIST PRINT** soft key. The marker value is printed out from the internal printer.
4. To cancel a print job which is in progress, press the **COPY CANCEL** soft key, which appears after this key is pressed.

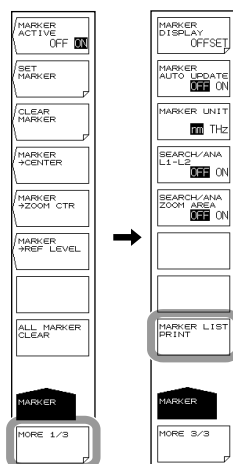

### Displaying Wavelength Line Markers

1. Press the **MARKER**. The soft key menu for marker settings appears.
2. Press the **MORE 1/3** soft key.
3. Press the **LINE MARKER 1 OFF/ON** or **LINE MARKER 2 OFF/ON** soft key to turn the function ON. Line marker values are displayed in the upper left of the waveform area.

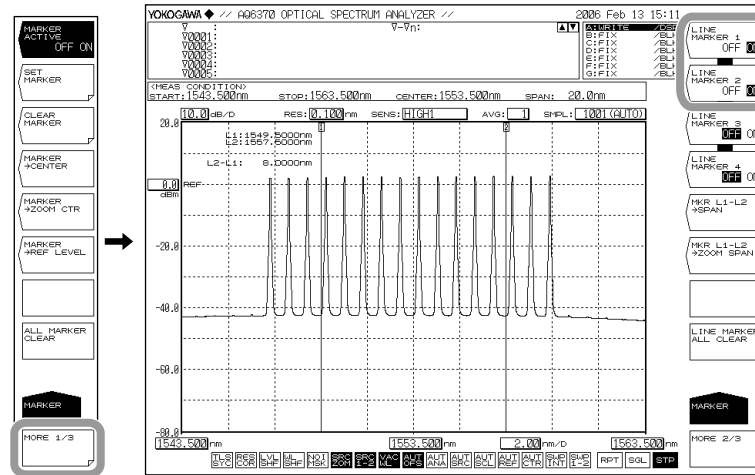

**Note**

- Wavelength line markers cannot be displayed if the active trace measurement span is 0.000 nm.
- When both wavelength line markers 1 and 2 are displayed, the wavelength difference (L2–L1) is shown below the marker values.

### Moving Line Markers

4. Refer to the following and move the line marker.

Direction	Moving Procedure
Move to right	Turn the rotary knob to the right. Press the UP arrow key.
Move to left	Turn the rotary knob to the left. Press the DOWN arrow key.

### Clearing Line Markers

1. Press the **MARKER**. The soft key menu for marker settings appears.
2. Press the **MORE 1/3** soft key.
3. Press the **LINE MARKER 1 OFF/ON** or **LINE MARKER 2 OFF/ON** soft key to turn the function OFF.

## Setting Measurement Sweep Width & Display Sweep Width with Line Markers

### Setting the Measurement Sweep Width between Line Markers 1 and 2

<<See section 5.6 for details>>

With line marker 1 and 2 displayed, press the **MRK L1-L2 ->SPAN** soft key. The sweep width setting screen and setting value are displayed. The measurement sweep width, measurement start wavelength, and measurement stop wavelength are changed. The measurement sweep width can be set by continuing in the DATA ENTRY section. The available setting range is 0.1 to 1100 nm (in 0.1 nm steps).

### Setting the Area from Line Marker 1 to Line Marker 2 as the Display Scale ZOOM SPAN

With line marker 1 and 2 displayed, press the **MRK L1-L2 ->ZOOM SPAN** soft key. The display sweep width setting screen and setting value are displayed. You can also rewrite the currently displayed waveform according to the specified ZOOM SPAN.

#### Note

- If only one of the line markers is displayed, for L1, the wavelength on the right edge of the screen is set to the measurement stop wavelength. For L2, the wavelength on the left edge of the screen is set to the measurement start wavelength.
- The MKR L1-L2 ->ZOOM SPAN soft key cannot be used under the following conditions.
  - When both L1 and L2 are OFF.
  - When both SPLIT screens are on HOLD.
  - When the span of the active trace is 0 nm.

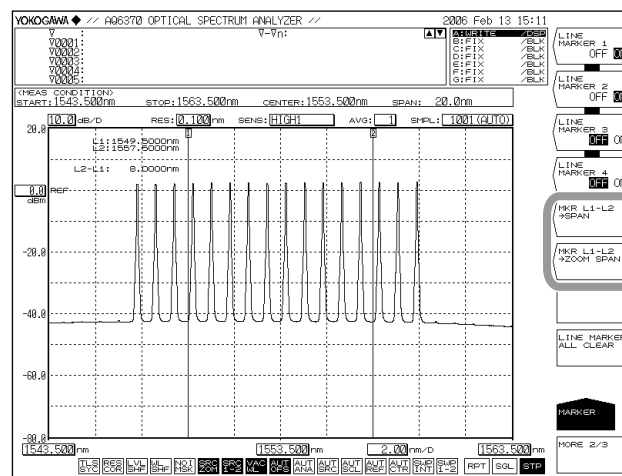

#### Note

For information on analysis inside the line markers, see section 7.13, "Specifying an Analysis Range."

### Displaying Level Line Markers

1. Press the **MARKER** switch. The soft key menu for marker settings appears.
2. Press the **MORE 1/3** soft key.
3. Press the **LINE MARKER 3 OFF/ON** or **LINE MARKER 4 OFF/ON** soft key to turn the function ON. Line marker values are displayed in the upper left of the waveform area.

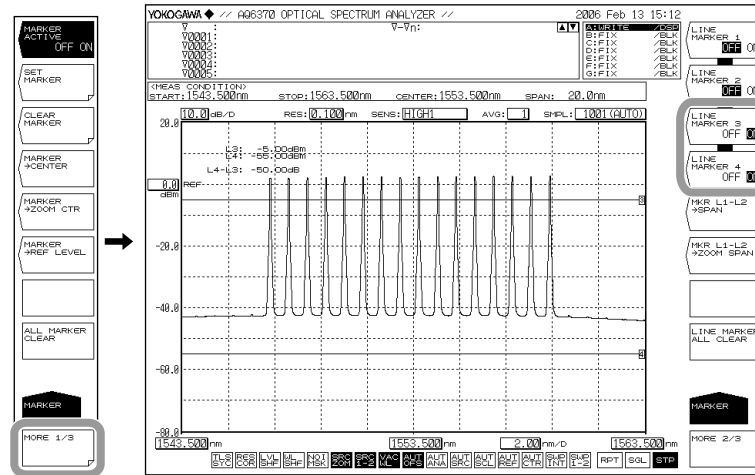

**Note**

When level line markers 3 and 4 are displayed, the level difference (L4–L3) is shown below the marker values.

### Moving Level Line Markers

4. Refer to the following and move the level line marker.

Direction	Moving Procedure
Move upward	Turn the rotary knob to the right. Press the UP arrow key.
Move downward	Turn the rotary knob to the left. Press the DOWN arrow key.

### Clearing All Cursors

Press the **LINE MARKER ALL CLEAR** soft key. All markers (wavelength line markers and level line markers) displayed on the screen are cleared.

**Explanation**

**Markers**

**Moving Markers**

Line markers can be moved to an arbitrary wavelength using the rotary knob, arrow keys, or numeric key pad. You can also drag the markers with the mouse.

Moving markers can be moved over a waveform to display the marker value in the data area. If a moving marker is fixed in an arbitrary position, a fixed marker is displayed.

**Fixed Markers**

Fixed markers are markers fixed to number to which a moving marker was specified. A maximum of 1024 fixed markers can be set. In addition, fixed markers can be set across different traces.

Fixed markers are assigned marker numbers in order starting from 001. You can enter an arbitrary number using the rotary knob, arrow keys, or numeric key pad. A number up to 1024 can be set.

**Marker Data in the Data Area**

Marker values (wavelength values and level values) for the displayed moving and fixed markers are shown in the data area.

If there are five or more fixed markers, they cannot all be displayed in the data area. To view the values of markers that are not displayed, scroll through the display using the arrow keys. You can scroll when moving markers are ON and active.

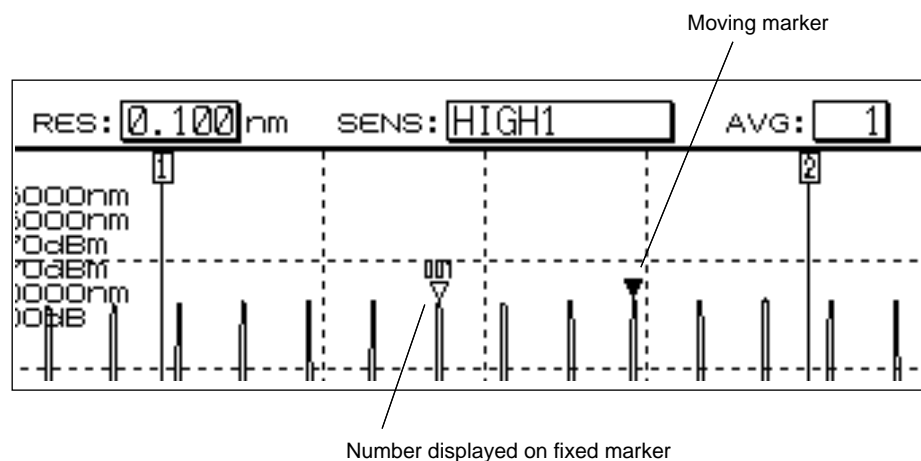
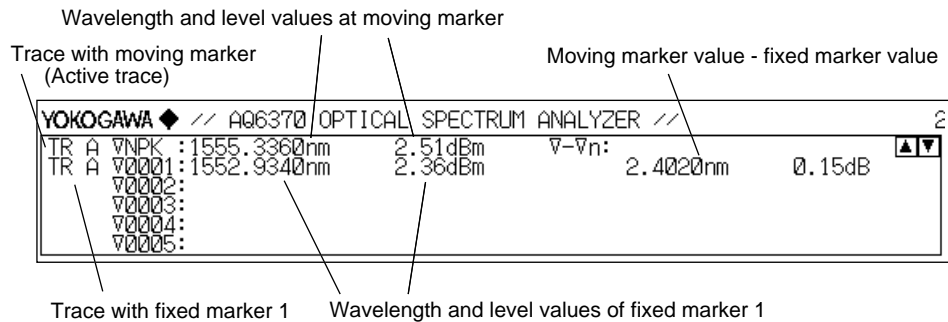

**MARKER DISPLAY**

This key is used to set whether to display the difference relative to the moving marker (OFFSET) or the difference relative to the next marker (SPACING) in the marker display (Fig. 6-10 "Data area when MARKER DISPLAY is set to OFFSET" and Fig. 6-11 "Data area when MARKER DISPLAY is set to SPACING"). (Default: OFFSET)

If the active trace span is 0 nm, the wavelength difference relative to the moving marker is 0.000 nm.

If a fixed marker is placed at the -210 dBm wavelength value, "???????" is displayed as the level difference from that fixed marker.

When a fixed marker is positioned and the moving marker is set to a wavelength value of -210 dBm, the level difference is set to 23.22 dB, regardless of the fixed marker's level.

**OFFSET**

Sets the difference value display as the difference between each marker and the moving marker (OFFSET).

TR A ▽	:1543.8500nm	2.27dBm	▽-▽n:	
TR A ▽0001:	1543.8300nm	-20.77dBm	0.0200nm	23.03dB
TR A ▽0002:	1543.8100nm	-33.43dBm	0.0400nm	35.69dB
TR A ▽0003:	1543.7900nm	-45.93dBm	0.0600nm	48.20dB
▽0004:				
▽0005:				

Data area when MARKER DISPLAY is set to OFFSET

**SPACING**

Sets the difference value display as the difference between each marker and the next marker.

TR A ▽	:1543.8500nm	2.27dBm	SPACING:	
TR A ▽0001:	1543.8300nm	-20.77dBm	-0.0200nm	-23.03dB
TR A ▽0002:	1543.8100nm	-33.43dBm	-0.0200nm	-12.66dB
TR A ▽0003:	1543.7900nm	-45.93dBm	-0.0200nm	-12.50dB
▽0004:				
▽0005:				

Data area when MARKER DISPLAY is set to SPACING

## Line Markers

### Wavelength Line Markers

When line markers are displayed, the marker values are shown in the upper left part of the waveform area.

When both wavelength line markers 1 and 2 are displayed, the wavelength difference (L2-L1) is shown below the marker values.

### Level Line Markers

When line markers are displayed, the marker values are shown in the upper left part of the waveform area. When level line markers 3 and 4 are displayed, the level difference (L4-L3) is shown below the marker values.

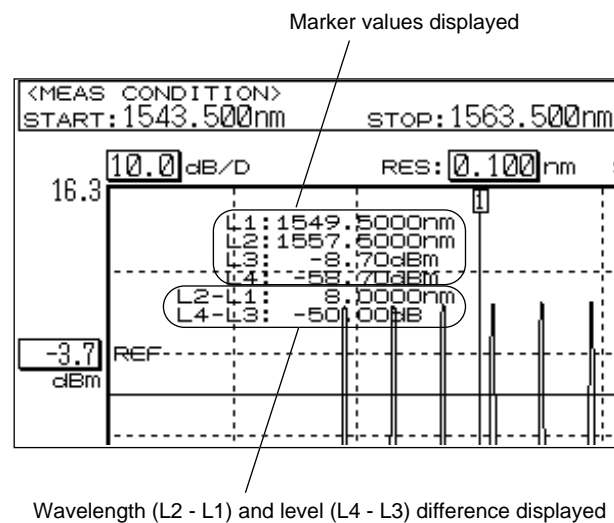

### Note

You can move line markers by dragging them. As you drag, the line markers in the overview window move accordingly.

### Line Markers in the Overview Window

The instrument's OVERVIEW window is displayed when the display scale is enlarged or reduced. When line markers are displayed, they are also displayed on the OVERVIEW window. When a line marker is moved on the OVERVIEW window, it also moves in the waveform area. When moving a line marker, the mouse pointer changes to a hand tool.

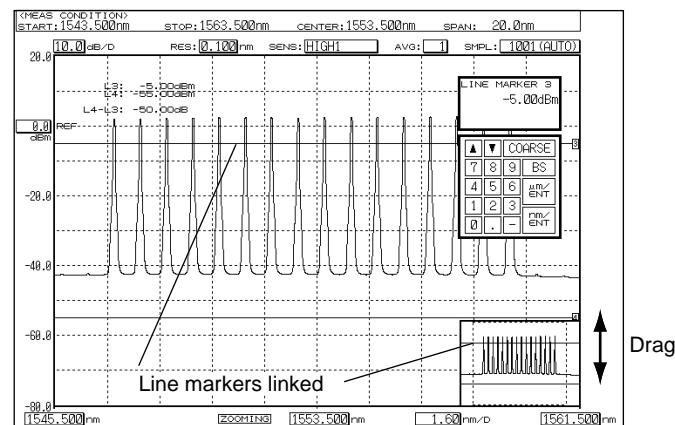

## 6.9 Displaying a Split Screen

### Procedure

#### Splitting the Screen

1. Press **DISPLAY**. The soft key menu for setting the screen display appears.
2. Press the **SPLIT DISPLAY** soft key. The screen splits into upper and lower splits.

#### Displaying a Trace in Either the Upper or Lower Split

3. Press the soft key corresponding to the desired trace. Each time you press the soft key, the display screen toggles between UP and LOW. You can alternately select the upper or lower display for Trace A. For Trace A, the default is Upper. The default for Traces A, B, D, and E is Upper. The default for Trace C, F, and G is Lower.

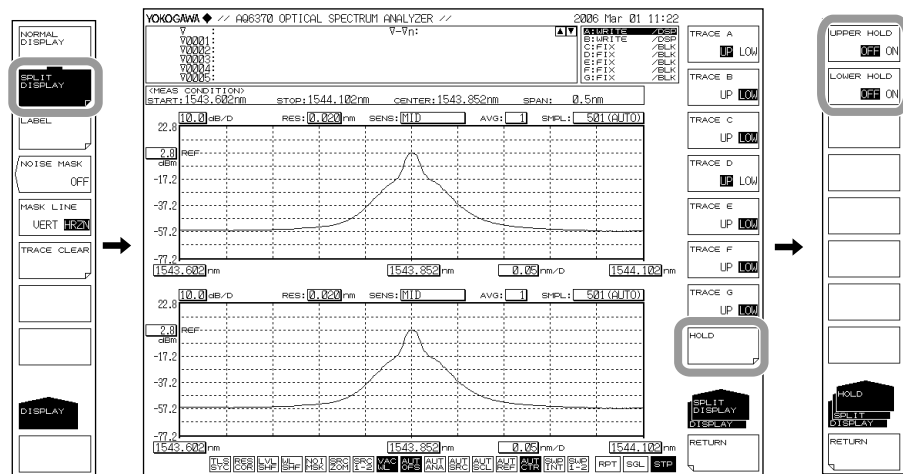

#### Fixing a Trace

3. Press the **HOLD** soft key.

#### Fixing/Releasing the Upper Trace

4. Press the **UPPER HOLD OFF/ON** soft key. The trace assigned to the upper split is fixed, along with the scale. To release the trace, press the **UPPER HOLD OFF/ON** soft key again. The display scale and waveform are updated.

#### Fixing/Releasing the Lower Trace

4. Press the **LOWER HOLD OFF/ON** soft key. The trace assigned to the lower split is fixed, along with the scale. To release the trace, press the **LOWER HOLD OFF/ON** soft key again. The display scale and waveform are updated.

#### Returning to Normal Display

1. Press **DISPLAY**. The soft key menu for setting the screen display appears.
2. Press the **NORMAL DISPLAY** soft key. The screen returns to normal display (1 screen).

**Explanation****HOLD**

The Hold function is used when displaying measured waveforms with the upper and lower portions of the screen having different wavelength ranges.

For example, after measuring trace A in the upper screen, you can hold the upper screen, change measurement conditions, then measure trace B in the lower screen.

HOLD has the characteristics below. These are the same for the upper and lower splits.

- The display scale is fixed.
- The trace is fixed.
- When HOLD is applied to a screen with the active trace (WRITE @), the active trace automatically changes to the FIX state. (FIX @)
- When a screen setting is changed from the HOLD state to NORMAL DISPLAY, the last set display scale is set as the display scale.
- When a trace in the HOLD state (FIX state) is set to a state other than FIX, the HOLD is cleared automatically. When this happens, a warning message is displayed.

## 6.10 Noise Mask

### Procedure

1. Press **DISPLAY**. The soft key menu for setting the screen display appears.
2. Press the **NOISE MASK** soft key. The noise mask value setting screen is displayed.
3. Enter a noise mask value using the rotary knob, arrow keys, or numeric key pad.
4. Press **ENTER**.
5. Press the **MASK LINE VERT/HRZN** soft key and select **VERT** or **HRZN**.

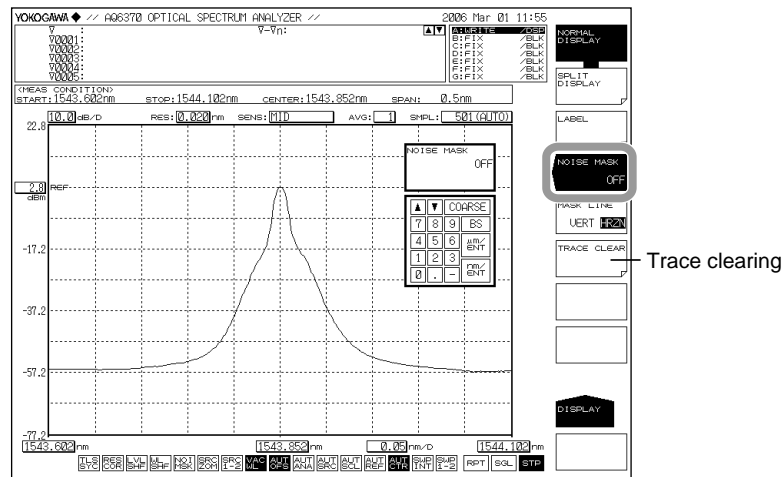

### Note

The allowed setting range for the noise mask value is OFF (-999), and -100–0. Settings can be adjusted in steps of 1. The value changes in steps of 10 if you press the COARSE key.

**Explanation**

**Noise Masking**

**HRZN**

Displays the waveform with level values at or below the mask value as the mask value.

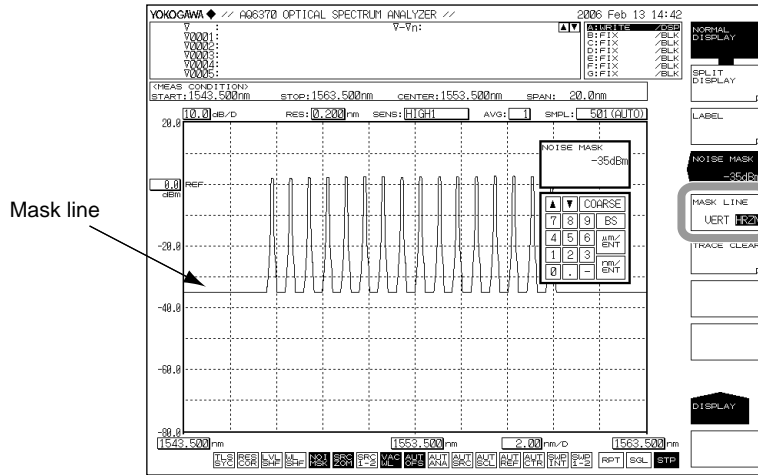

**VERT**

Displays the waveform with level values at or below the mask value as the display lower limit value (-210 dBm).

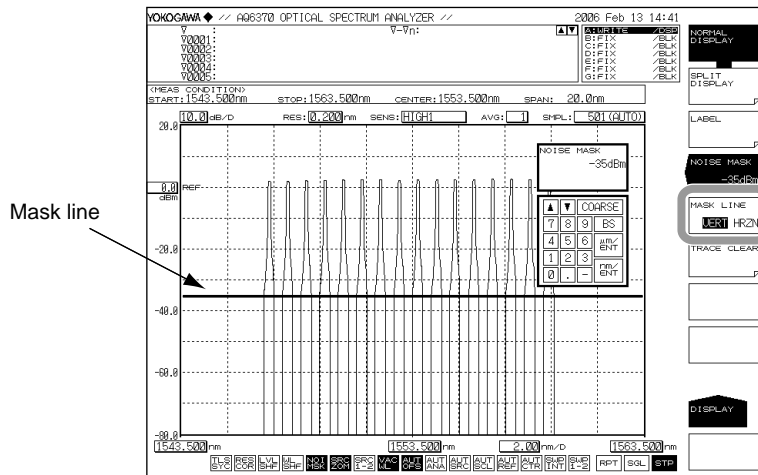

**Note**

The noise mask function is disabled when the vertical axis is linear.

## 6.11 Copying and Clearing Traces

### Procedure

#### Copying Traces

1. Press **TRACE**. The soft key menu for trace settings appears.
2. Press the **MORE 1/2** soft key.
3. Press the **TRACE COPY** soft key.
4. Press the **SOURCE TRACE** soft key and select the copy source trace (A to G).  
The screen returns to the previous state after a selection is made.
5. Press the **DESTINATION TRACE** soft key and select the copy destination trace (A to G).  
The screen returns to the previous state after a selection is made.
6. Press the **COPY EXECUTE** soft key. The copy executes.

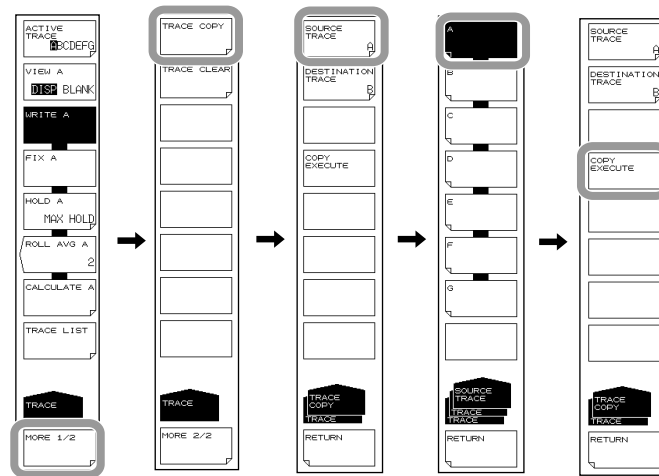

#### Note

- After the copy is executed, the copy destination trace status changes to FIX and DISP.
- If the copy source and destination trace are the same, the COPY EXECUTE soft key is disabled.

### Clearing Traces

1. Press **TRACE**. The soft key menu for trace settings appears.
2. Press the **MORE 1/2** soft key.
3. Press the **TRACE CLEAR** soft key.
4. Press the soft key (A through G) corresponding to the trace of the data you wish to clear.
5. To clear the data from all traces, press the **ALL TRACE** soft key.

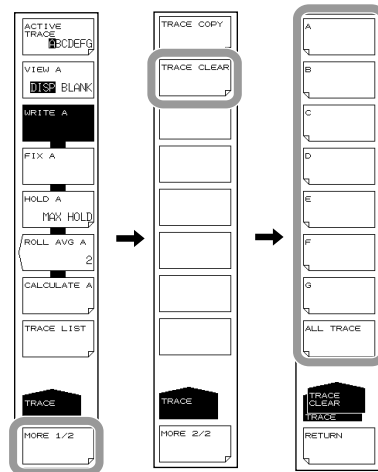

### Trace List

1. Press **TRACE**. The soft key menu for trace settings appears.
2. Press the **TRACE LIST** soft key.

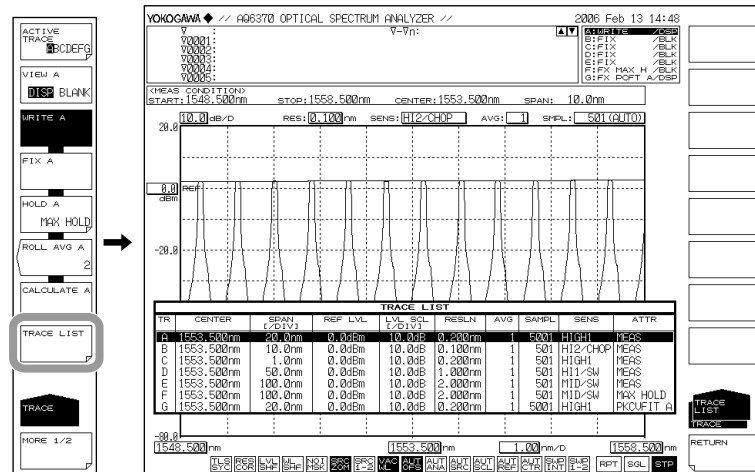

## 6.12 Searching

### Procedure

#### Finding the Peak Wavelength/Level

1. Press **PEAK SEARCH**. The menu for searching for the peak value is displayed.
2. Press the **PEAK SEARCH** soft key. The moving marker is set on the waveform peak (the maximum level value) and the marker value is displayed in the data area.

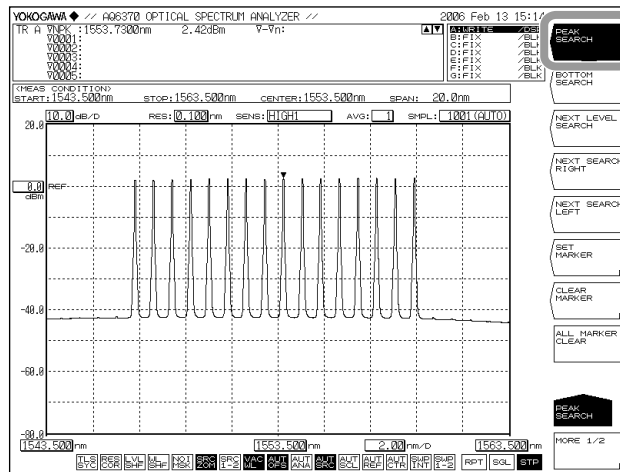

#### Finding the Bottom Wavelength/Level

2. Continuing on from step 1, press the **BOTTOM SEARCH** soft key. The moving marker is set on the waveform bottom (the minimum level value) and the marker value is displayed in the data area.

#### Note

- If the active trace is not set to DISP, the moving marker cannot be used. Set the trace VIEW @ DISP/BLANK soft key setting to DISP.
- Even if you press PEAK SEARCH the moving marker is displayed.

#### Finding the Next Peak/Bottom Level

3. With the moving marker displayed at a waveform peak or bottom, press the **NEXT LEVEL SEARCH** soft key. The moving marker is placed on the next peak (maximum level value) or bottom (minimum level value).

#### Finding the Level Peak/Bottom to the Right of the Marker

3. With the moving marker displayed at a waveform peak or bottom, press the **NEXT SEARCH RIGHT** soft key. The moving marker is placed on the peak (maximum level value) or bottom (minimum level value) to the right of its current position.

#### Finding the Level Peak/Bottom to the Left of the Marker

3. With the moving marker displayed at a waveform peak or bottom, press the **NEXT SEARCH LEFT** soft key. The moving marker is placed on the peak (maximum level value) or bottom (minimum level value) to the left of its current position.

## Setting the Minimum Peak/Bottom Difference of the Mode Judgment Reference

1. Press **PEAK SEARCH**. The menu for detecting the peak value is displayed.
2. Press the **MORE 1/2** soft key. The 2/2 soft key screen is displayed.
3. Press the **MODE DIFF** soft key. The screen for setting the minimum peak/bottom difference of the mode judgment reference is displayed.
4. Enter a peak/bottom difference using the rotary knob, arrow keys, or numeric key pad.
5. Press **nm/ENTER**.

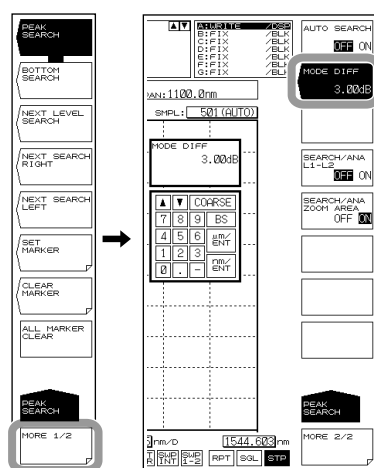

## Auto Search

1. Press **PEAK SEARCH**. The menu for searching for the peak value is displayed.
2. Press the **MORE 1/2** soft key. The 2/2 soft key screen is displayed.
3. Press the **AUTO SEARCH** soft key.

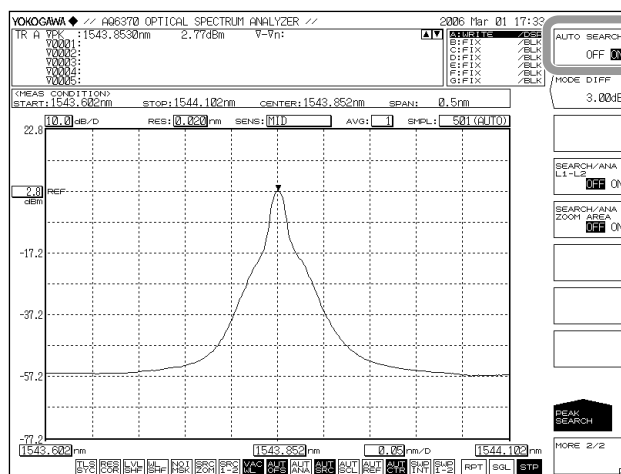

### Explanation

#### Peak Search

You can detect the peak or bottom values of the measured waveform. The following explains the soft keys related to peak searches.

##### **PEAK SEARCH**

Executes a peak search (a search for a maximum level value) on the active trace waveform. A moving marker is placed, and the marker value is displayed in the data area. If the peak level is above the screen top or below the screen bottom, a marker is displayed at the screen top or bottom, but the actual (correct) marker value is displayed in the data area. After measurement the marker can be moved with the rotary knob. Or, if you press an arrow key, you can scroll the data area.

##### **BOTTOM SEARCH**

Executes a bottom search (a search for a minimum level value) on the active trace waveform. A moving marker is placed, and the marker value is displayed in the data area. If the bottom level is above the screen top or below the screen bottom, a marker is displayed at the screen top or bottom, but the actual (correct) marker value is displayed in the data area. After measurement the marker can be moved with the rotary knob. Or, if you press an arrow key, you can scroll the data area.

##### **NEXT LEVEL SEARCH**

Sets a moving marker at the peak (maximum level value) or bottom (minimum level value) which follows the currently set moving marker value (level value) in the active trace waveform. If there is no such peak or bottom, a warning data is displayed.

WARNING 103 : No data in active trace

##### **NEXT SEARCH RIGHT**

Sets a moving marker at the peak (maximum level value) or bottom (minimum level value) to the right of the currently set moving marker value (level value) in the active trace waveform. If there is no such peak or bottom, a warning data is displayed.

WARNING 103 : No data in active trace

##### **NEXT SEARCH LEFT**

Sets a moving marker at the peak (maximum level value) or bottom (minimum level value) to the left of the currently set moving marker value (level value) in the active trace waveform. If there is no such peak or bottom, a warning data is displayed.

WARNING 103 : No data in active trace

##### **SET MARKER    SET**

Sets the moving marker as a fixed marker with the specified number.

A number from 001 to 1024 can be specified. The default is one greater than the highest fixed marker number among the currently set markers, or the number 001 if no markers have been set). If the MARKER ACTIVE soft key turns OFF, the SET MARKER soft key is disabled.

##### **CLEAR MARKER    CLEAR**

Clears the specified fixed marker number. The marker value in the data area is also cleared. The fixed marker number to be cleared (default value) is the last set fixed marker number.

**ALL MARKER CLEAR**

This key is used to clear all currently displayed moving markers and fixed markers.

**MODE DIFF \*.\*dB**

This key is used to set the minimum peak/bottom difference (dB) serving as a basis for mode determination during mode detection.

When you press this key, the setting screen and current setting value are displayed. The available setting range is 0.01 to 50.00 dB (in 0.01 steps, coarse: steps of 1), and the value is set in the DATA ENTRY section. (Initial value: 3.00 dB.)

**SEARCH/ANA L1-L2 OFF/ON**

When set to ON and wavelength line markers WL1 and WL2 are set, peak searching, bottom searching (PEAK SEARCH key), and analysis function (ANALYSIS key) calculations are only applied between line markers 1 and 2.

The setting applies to the MARKER and PEAK SEARCH keys, and the SEARCH/ANA L1-L2 ANALYSIS key. If wavelength line markers WL1 and WL2 are not set, the SEARCH/ANA L1-L2 OFF / ON key is disabled. (Initial value: OFF.)

When this key is set to ON,  is displayed at the very bottom of the screen in reverse video.

**Note**

- If both WL1 and WL2 are set, execution applies over the span between line markers 1 and 2.
- If just WL1 is set, execution applies over the span from line marker 1 to the right edge of the screen.
- If just WL2 is set, execution applies over the span from the left edge of the screen to line marker 2.

**SEARCH/ANA ZOOM AREA OFF/ON**

When set to ON, peak searching, bottom searching (PEAK SEARCH key), and analysis function (ANALYSIS key) are only applied to data in the ZOOM SPAN range.

The setting applies to the MARKER and PEAK SEARCH keys, and the SEARCH/ANA L1-L2 ANALYSIS key. When this key and the SEARCH/ANA L1-L2 key are set to ON, calculations are applied to data that are both within the ZOOM SPAN range and between line markers 1 and 2. (Initial value: ON.)

When this key is set to ON,  is displayed at the very bottom of the screen in reverse video.

**Auto Search**

You can automatically detect the peak or bottom value every time a sweep is performed. The following explains the soft keys related to auto searches.

**AUTO SEARCH ON/OFF**

Turns ON/OFF peak/bottom searching to be performed every sweep.

When set to ON, a peak/bottom search is performed automatically and a moving marker is set automatically after sweeping ends. (Initial value: OFF.)

When this key is set to ON,  is displayed at the very bottom of the screen in reverse video.

# 7.1 Spectrum Width Measurement

## Procedure

Spectrum width can be measured from the measured waveform.

1. Press **ANALYSIS**. The soft key menu for analyzing measured waveforms appears.
2. Press the **SPEC WIDTH** soft key. The analysis algorithm selection menu is displayed.
3. Press the **THRESH**, **ENVELOPE**, **RMS**, or **PEAK RMS** soft key. Analysis is performed, and the results are displayed in the data area.

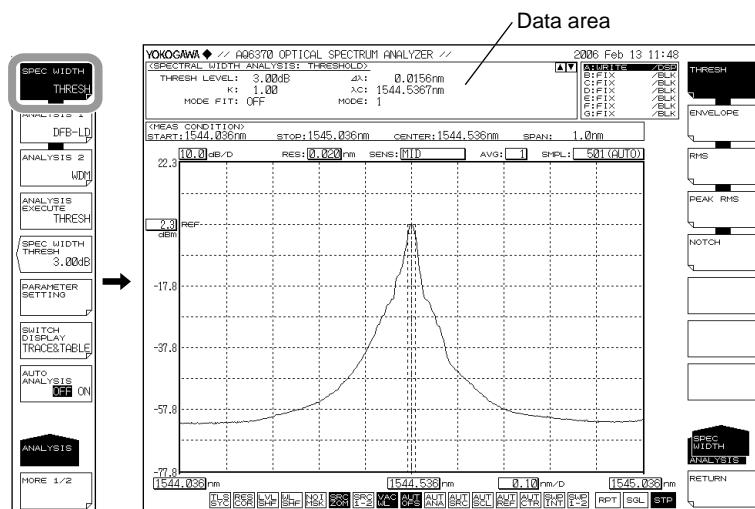

When changing the analysis parameters

4. Continuing on from step 3, press the **PARAMETER SETTING** soft key. The analysis parameter setting screen is displayed.
5. Move the cursor with the arrow keys, and enter a setting value with the numeric keypad.
6. Press the **CLOSE WINDOW** soft key. The analysis parameter setting screen closes, and the soft key menu returns to the previous stage.
7. Press the **ANALYSIS EXECUTE** soft key. Analysis is performed according to the changed parameters, and the results are displayed in the data area.

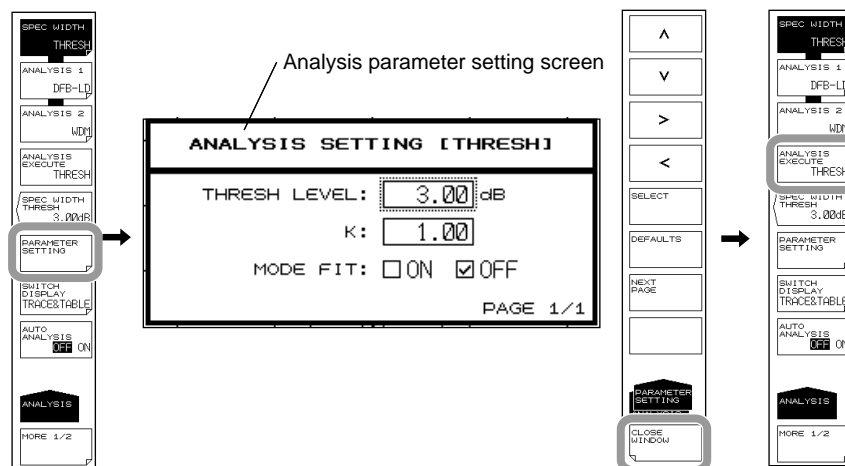

## 7.1 Spectrum Width Measurement

---

If you only want to change the THRESH LEVEL, you can also do so with the SPEC WIDTH THRESH soft key.

### Changing the Threshold Value for Each Algorithm

4. Continuing on from step 3, press the **SPEC WIDTH THRESH** soft key. The threshold setting screen is displayed.
5. Enter a value using the rotary knob, arrow keys, or numeric key pad.
6. Press **ENTER**.

### Automatic Analysis on Each Sweep

4. Continuing on from step 3, press the **AUTO ANALYSIS OFF ON** soft key to select ON. At the end of each sweep, the SPEC WIDTH, ANALYSIS 1, or ANALYSIS 2 function that was selected is executed automatically.

### Note

---

- If the AUTO SEARCH soft key is ON when the AUTO ANALYSIS soft key is turned ON, AUTO SEARCH is automatically turned OFF.
  - When the AUTO ANALYSIS soft key is set to ON,  is displayed at the bottom of the screen in inverse video.
- 

### Printing Out Analysis Results

2. Continuing on from step 1, press the **MORE 1/2** soft key.
3. Press the **RESULT PRINT** soft key. The results are printed out on the built-in printer.

### Saving Analysis Results

2. Continuing on from step 1, press the **MORE 1/2** soft key.
3. Press the **RESULT SAVE** soft key. The file list is displayed.
4. For the subsequent steps, see section 8.5, "Saving/Loading Analysis Results Data."

**Explanation****Algorithms****Algorithms for Spectrum Width Analysis**

Algorithm	Description
THRESH	Determines spectrum width from the width between points where the waveform crosses the threshold value.
ENVELOPE	Determines spectrum width from waveform envelope.
RMS	Determines spectrum width from waveform standard deviation.
PEAK RMS	Determines spectrum width from waveform mode peak standard deviation.

**Note**

- For details about the spectrum width analysis algorithms and parameters, see appendix 2, "Data Calculation Algorithms for Spectrum Widths."
- For information on NOTCH, see section 7.2, "Notch Width Measurement."

**Results Display**

The analysis results are displayed in the data area.

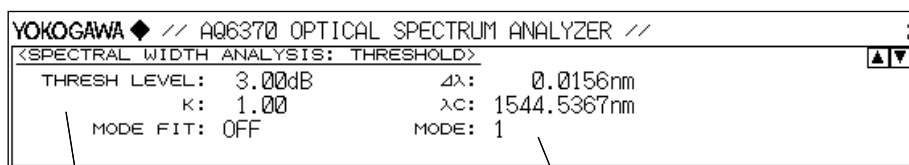

Analysis parameter setting value

Analysis results

$\Delta\lambda$ : Spectrum width

$\lambda_c$ : Spectrum width center

**SPEC WIDTH THRESH**

You can set threshold values for each spectrum width analysis algorithm. After the setting is made, analysis is executed and the display is updated.

The setting range is 0.01 to 50.00 dB. Settings can be adjusted in steps of 0.01. The value changes in steps of 1.00 if you press the COARSE key. The value is set in the DATA ENTRY section. This setting is held independently by each analysis algorithm. If the SPEC WIDTH soft key is OFF, this soft key is disabled.

The value set by this soft key is shared by the analysis parameter setting screen under the PARAMETER SETTING soft key.

## 7.2 Notch Width Measurement

### Procedure

With notch width measurement, it is possible to measure notch width (pass band width/notch width) from the measured waveform of a filter with V-character type or U-character type wavelength characteristics.

1. Press **ANALYSIS**. The soft key menu for analyzing measured waveforms appears.
2. Press the **SPEC WIDTH** soft key. The analysis algorithm selection menu is displayed.
3. Press the **NOTCH** soft key. Analysis is performed, and the results are displayed in the data area.

Notch width measured waveform (BOTTOM)

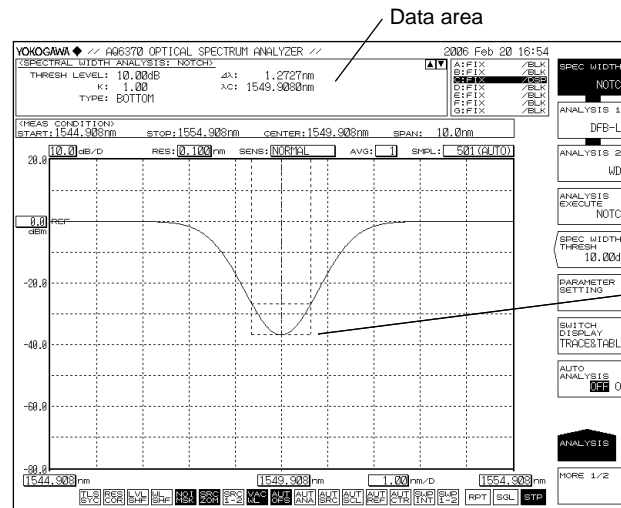

Notch width measured waveform (PEAK)

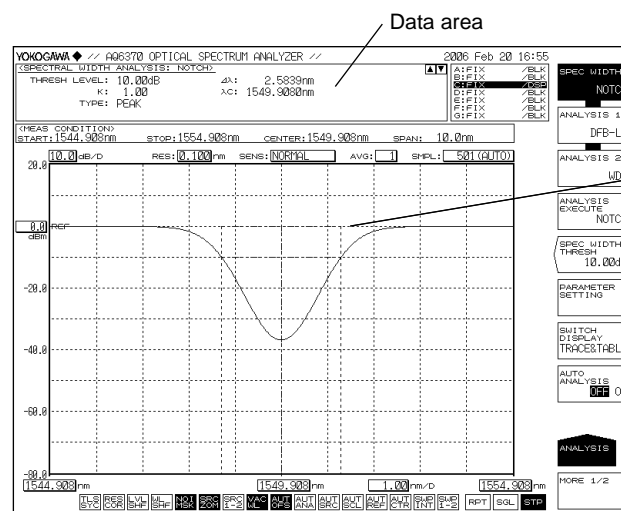

When changing the analysis parameters

4. Continuing on from step 3, press the **PARAMETER SETTING** soft key. The notch analysis parameter setting screen is displayed.
5. Move the cursor with the arrow keys or soft keys, and enter a setting value with the numeric key pad. To switch PEAK and BOTTOM, press the **SELECT** soft key.
6. Press the **CLOSE WINDOW** soft key. The analysis parameter setting screen closes, and the soft key menu returns to the previous stage.
7. Press the **ANALYSIS EXECUTE** soft key. Analysis is performed according to the changed parameters, and the results are displayed in the data area.

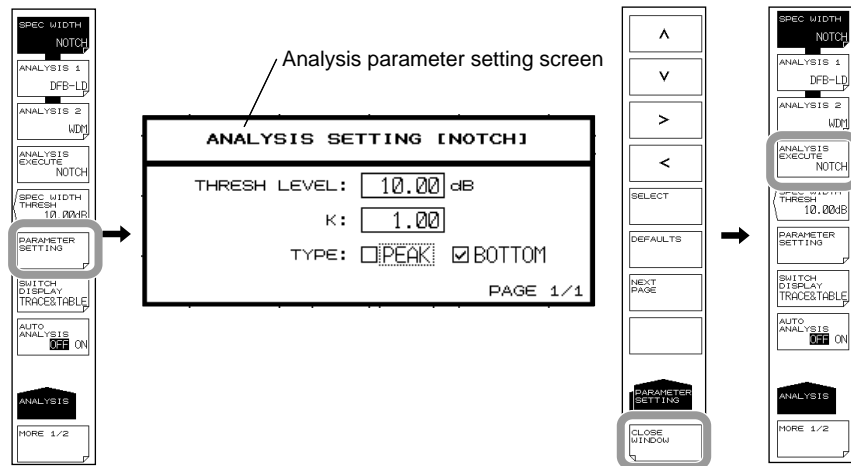

### Note

For details about the notch width analysis algorithms and parameters, see appendix 2, "Data Calculation Algorithms for Spectrum Widths."

## 7.3 SMSR Measurement

### Procedure

You can measure SMSR from the measured waveform of a DFB-LD.

1. Press **ANALYSIS**. The soft key menu for analyzing measured waveforms appears.
2. Press the **ANALYSIS 1** soft key. The analysis function selection menu is displayed.
3. Press the **SMSR** soft key. Analysis is performed, and the results are displayed in the data area.

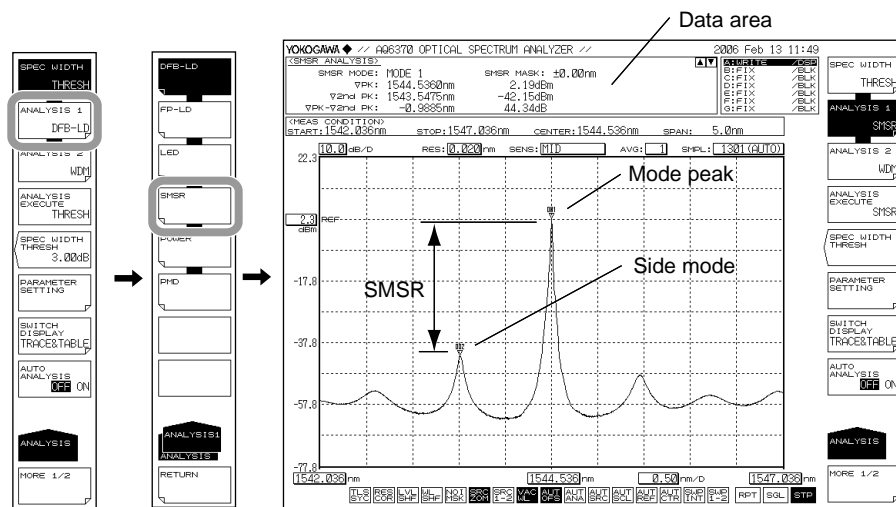

When changing the analysis parameters

4. Continuing on from step 3, press the **PARAMETER SETTING** soft key. The SMSR measurement parameter setting screen is displayed.
5. Move the cursor with the arrow keys or soft keys, and enter a setting value with the numeric key pad. To switch SMSR1 and SMSR2, press the **SELECT** soft key.
6. Press the **CLOSE WINDOW** soft key. The SMSR measurement parameter setting screen closes, and the soft key menu returns to the previous stage.
7. Press the **ANALYSIS EXECUTE** soft key. Analysis is performed according to the changed parameters, and the results are displayed in the data area.

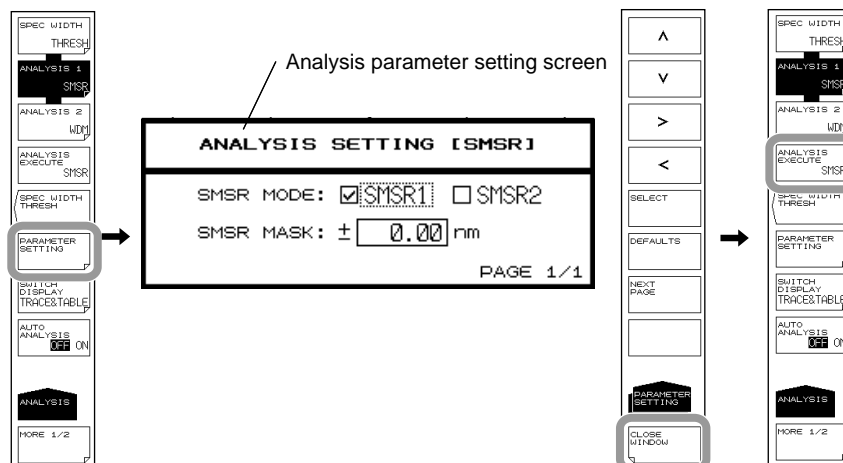

**Explanation**

**SMSR**

SMSR stands for side-mode suppression ratio. SMSR represents the difference between the mode peak and the side-mode level. It is one of the parameters used to evaluate the performance of DFB-LDs and the like.

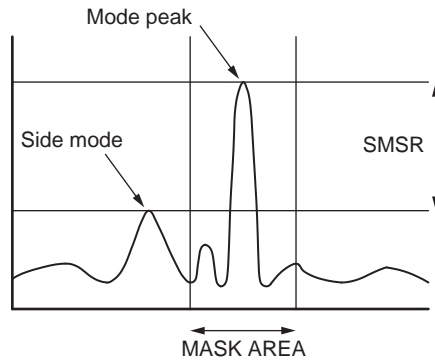

**Note**

For details on SMSR analysis algorithms, see appendix 3, "Details of Analysis Functions."

**Results Display**

The analysis results are displayed in the data area.

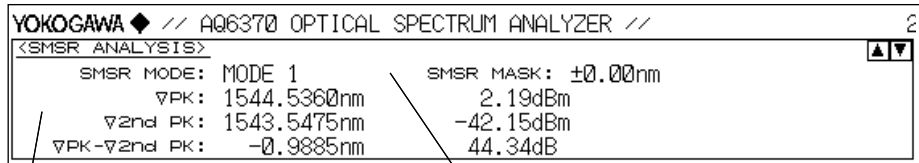

Analysis results

- ▽PK: Mode peak wavelength, level value
- ▽2nd PK: Side mode wavelength, level value

Analysis parameter setting value

- MODE 1: Set the 2nd peak excluding the MASK AREA as the side mode.
- SMSR MASK: Mask setting range

## 7.4 POWER Measurement

### Procedure

Optical power can be measured by integrating the measured waveform level values.

1. Press **ANALYSIS**. The soft key menu for analyzing measured waveforms appears.
2. Press the **ANALYSIS 1** soft key. The analysis function selection menu is displayed.
3. Press the **POWER** soft key. Analysis is performed, and the results are displayed in the data area.

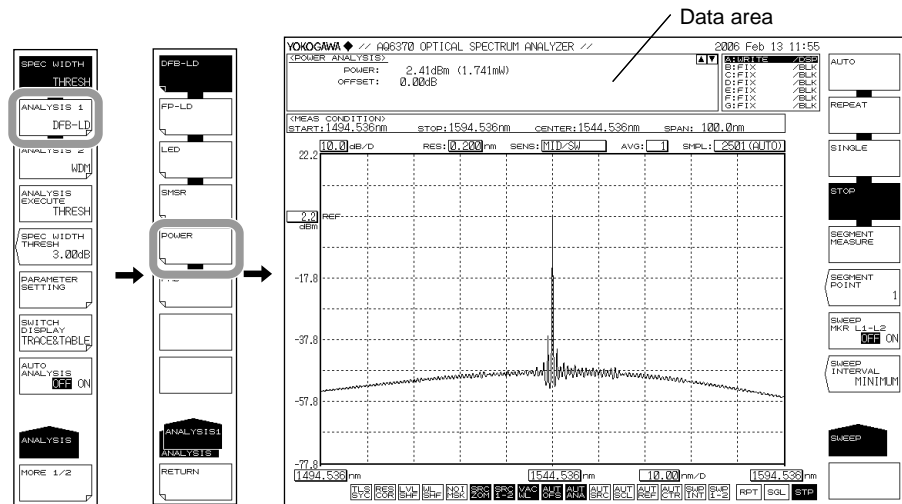

When changing the analysis parameters

4. Continuing on from step 3, press the **PARAMETER SETTING** soft key. The power offset setting screen is displayed.
5. Enter a setting value with the numeric key pad.
6. Press the **CLOSE WINDOW** soft key. The power offset setting screen closes, and the soft key menu returns to the previous stage.
7. Press the **ANALYSIS EXECUTE** soft key. Analysis is performed according to the changed parameters, and the results are displayed in the data area.

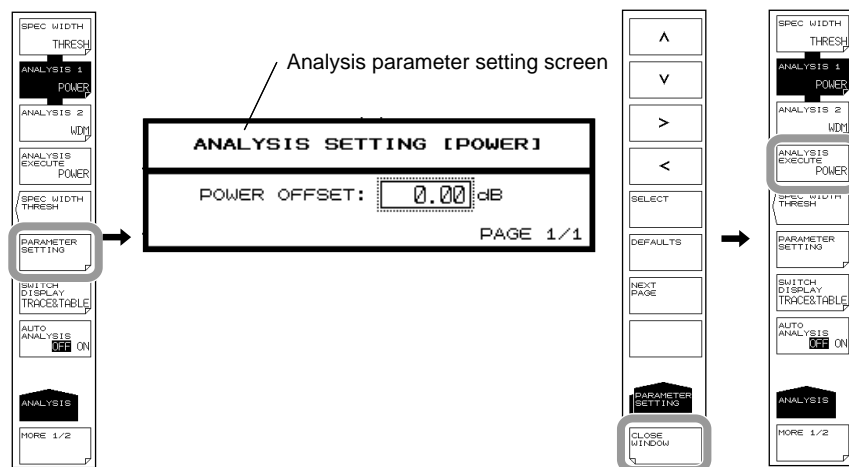

### Note

For details on POWER analysis algorithms, see appendix 3, "Details of Analysis Functions."

## 7.5 DFB-LD, FP-LD, and LED Measurement

### Procedure

Light source parameters can be analyzed from the measured waveform of each light source (DFB-LD, FP-LD, LED).

1. Press **ANALYSIS**. The soft key menu for analyzing measured waveforms appears.
2. Press the **ANALYSIS 1** soft key. The analysis function selection menu is displayed.
3. Press the **DFB-LD**, **FP-LD**, or **LED** soft key according to the type of light source to be analyzed. Analysis is performed, and the results are displayed in the data area.

Example of a measured waveform of an FP-LD

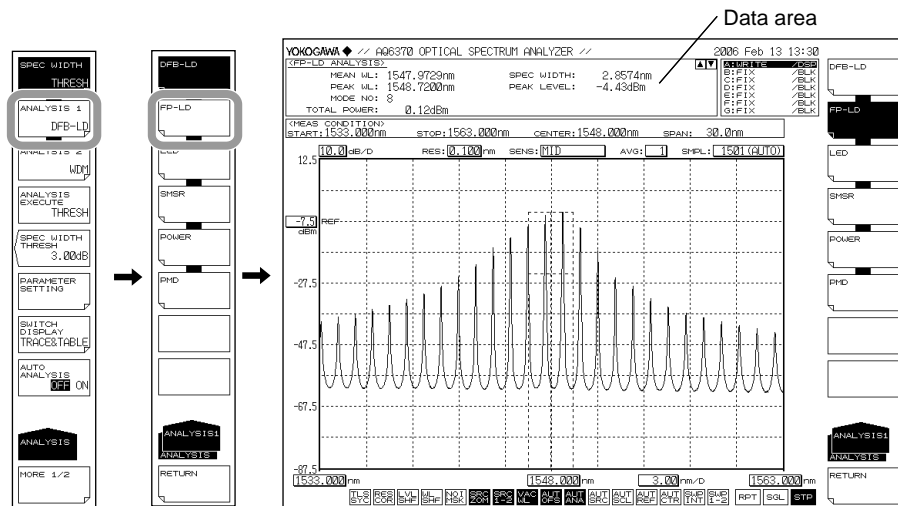

When changing the analysis parameters

4. Continuing on from step 3, press the **PARAMETER SETTING** soft key. The measurement parameter setting screen for the type of light source selected is displayed.
5. Move the cursor with the arrow keys or soft keys, and enter a setting value with the numeric key pad. To select a check box, align the cursor then press the **SELECT** soft key.
6. Press the **CLOSE WINDOW** soft key. The measurement parameter setting screen closes, and the soft key menu returns to the previous stage.
7. Press the **ANALYSIS EXECUTE** soft key. Analysis is performed according to the changed parameters, and the results are displayed in the data area.

### Note

For details on the analysis algorithms for the DFB-LD, FP-LD, and LED light sources, see appendix 3, "Details of Analysis Functions."

## 7.6 PMD Measurement

### Procedure

It is possible to measure the polarization mode dispersion (PMD) from a measured waveform by using the instrument in combination with a wideband light source and a polarizer, polarization controller, and an analyzer.

1. Press **ANALYSIS**. The soft key menu for analyzing measured waveforms appears.
2. Press the **ANALYSIS 1** soft key. The analysis function selection menu is displayed.
3. Press the **PMD** soft key. Analysis is performed, and the results are displayed in the data area.

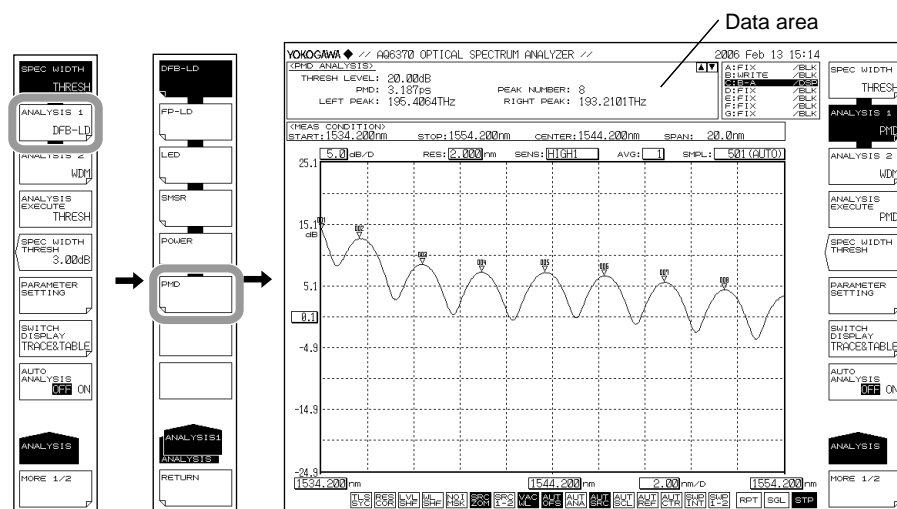

When changing the analysis parameters

4. Continuing on from step 3, press the **PARAMETER SETTING** soft key. The thresh level setting screen is displayed.
5. Enter a setting value with the numeric key pad.
6. Press the **CLOSE WINDOW** soft key. The thresh level setting screen closes, and the soft key menu returns to the previous stage.
7. Press the **ANALYSIS EXECUTE** soft key. Analysis is performed according to the changed parameters, and the results are displayed in the data area.

### Note

- When PMD measurement is performed, waveform data at or below the threshold level from the peak are not used in analysis. The threshold level is entered in the threshold level setting screen.
- The mode-determination threshold level during PMD analysis execution is set using the MODE DIFF soft key in the PEAK SEARCH menu. The level difference which exceeds the value set with the MODE DIFF soft key is recognized as a mode.
- See section 6.12 for how to set the mode judgment threshold value.
- For an explanation on the PMD analysis algorithms, see appendix 3, "Details of Analysis Functions."

PMD measurement is performed after loading of the waveform used for PMD measurement.

### Load the waveform for PMD measurement.

The following explains the structure of, and acquisition procedure for PMD measurement.

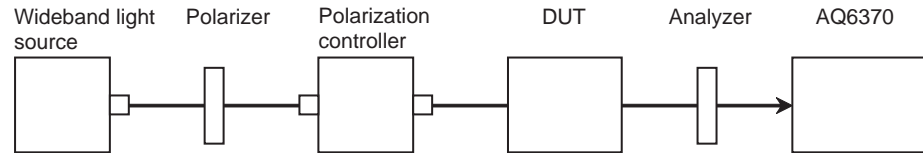

1. Enter measurement conditions so that the entire wavelength range of the wideband light source is measured. Set the resolution to about 0.050 nm.
2. Press **SWEEP**. Next, press the **REPEAT** soft key. Repeat sweeping begins.
3. While watching the waveform during repeat sweeping, adjust the polarization controller so as to maximize the waveform's peak/bottom difference (the level difference between the maximum and minimum values).
4. After the polarization controller has been adjusted, press the **SINGLE** soft key to perform a single sweep. Acquisition of measured waveforms is complete.

# 7.7 WDM Transmission Signal Analysis

## Procedure

You can measure the center wavelength, level, and SNR of each channel from the measured waveform of a WDM transmission signal.

1. Press **ANALYSIS**. The soft key menu for analyzing measured waveforms appears.
2. Press the **ANALYSIS 2** soft key. The analysis function selection menu is displayed.
3. Press the **WDM** soft key. Analysis is performed, and the results are displayed in a list. The analysis results display screen is switched with the **SWITCH DISPLAY** soft key.

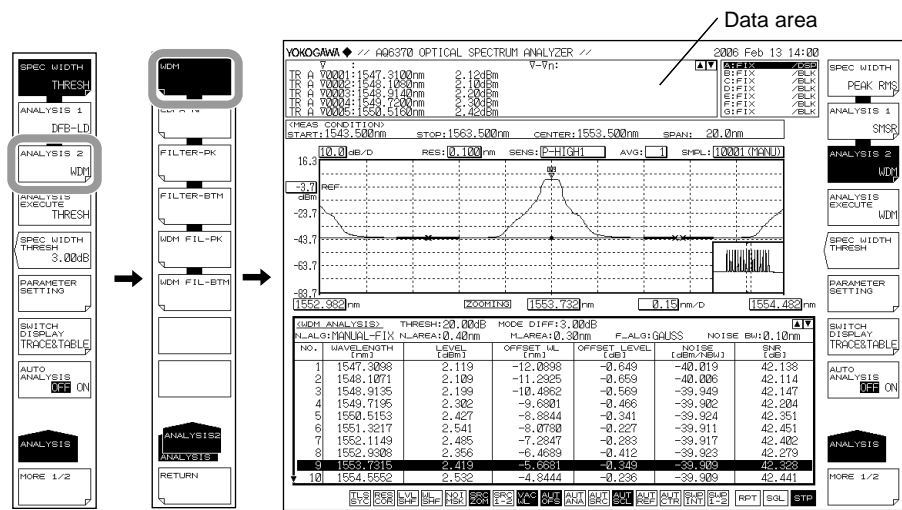

### Note

When zooming a waveform, if you click in the list of analysis results, the waveform of the selected channel is displayed in the center of the waveform screen.

When changing the analysis parameters

4. Continuing on from step 3, press the **PARAMETER SETTING** soft key. The WDM analysis parameter setting screen is displayed. If a setting screen has multiple pages, press the **NEXT PAGE** soft key to display the next screen.
5. Move the cursor with the arrow keys or soft keys, and enter a setting value with the numeric key pad. To select a check box, align the cursor then press the **SELECT** soft key.

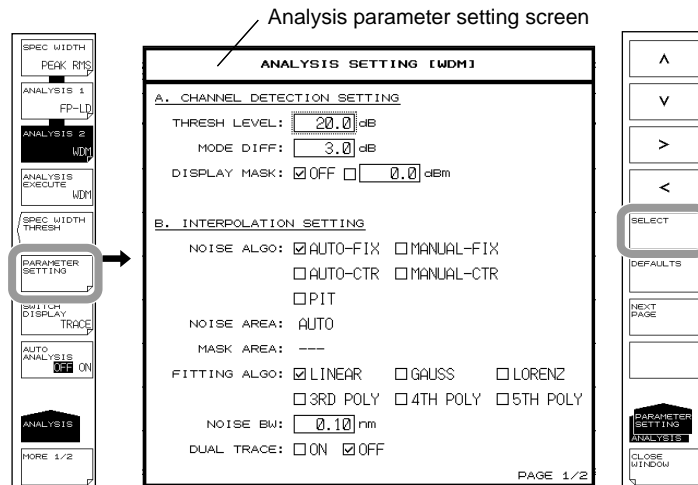

6. Press the **CLOSE WINDOW** soft key. The WDM analysis parameter setting screen closes, and the soft key menu returns to the previous stage.
7. Press the **ANALYSIS EXECUTE** soft key. Analysis is performed according to the changed parameters, and the results are displayed in a list.

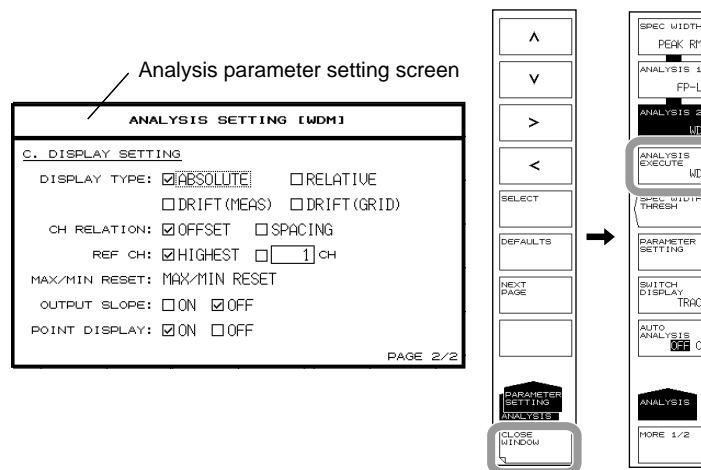

### Note

See appendix 4, "WDM Analysis Function" for a description of the WDM analysis algorithms and parameters.

**Explanation**

The following configuration is used to measure WDM transmission signals.

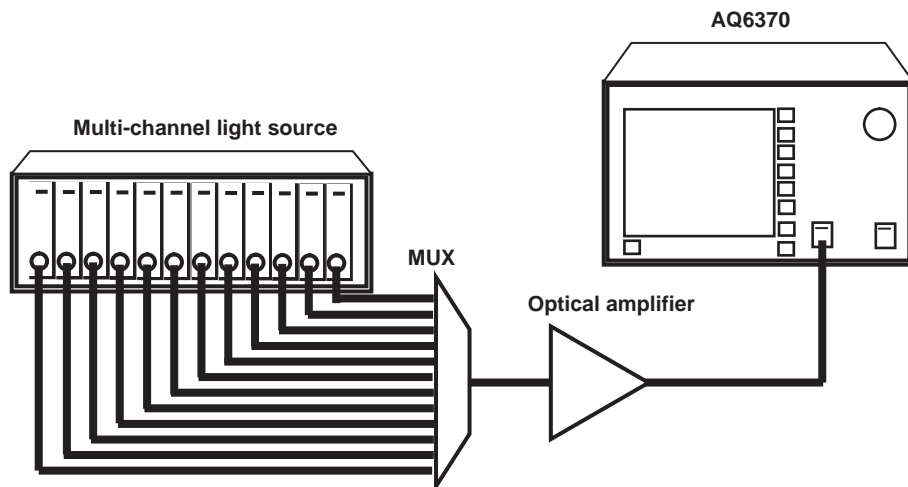

Measure the WDM signal light and write the waveform to the active trace.

**Setting Analysis Parameters**

The WDM analysis function parameters may be broadly divided into the following three configurations.

Parameter settings may be changed as desired according to the details of the particular analysis.

- Parameters related to channel detection (CHANNEL DETECTION SETTING)
- Parameters related to noise level measurement (INTERPOLATION SETTING)
- Parameters related to analysis results display method (DISPLAY SETTING)

These are explained below. See appendix 4, "WDM Analysis Function" for a description of the parameters.

## Parameter Settings Related to Channel Detection

These parameters are used to set threshold level and the like for WDM channel detection.

### THRESH LEVEL

This parameter is used to set the threshold level for channel detection.

This setting determines how far down in decibels from the peak level to detect a mode peak as a channel.

### MODE DIFF

This parameter sets the minimum value for the peak/bottom difference during channel peak detection.

If the waveform peak/bottom difference equals or exceeds this value, it is detected as a mode peak.

### DISPLAY MASK

This parameter sets the mask level value for channel masking.

Channels at a level equal to or below this setting are masked.

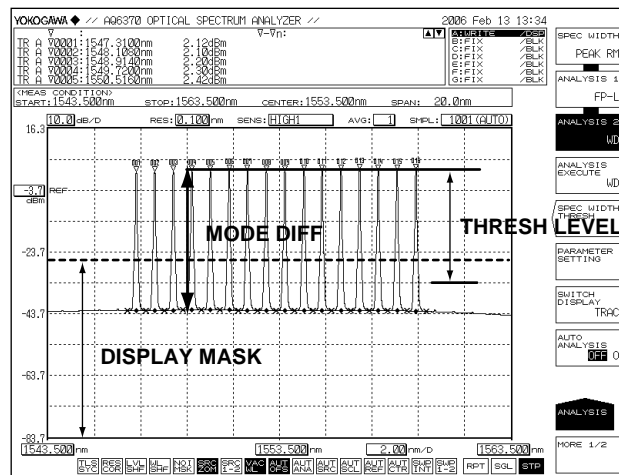

## Parameter Settings Related to Noise Level Measurement

These parameters are used to set the interpolation method and bandwidth for noise level measurement.

### NOISE ALGO

Select one of the five algorithms shown below for measuring the noise level.

If AUTO-FIX or AUTO-CTR is set, the measurement parameters at another noise level are set automatically. To set the values manually, select MANUAL-FIX or MANUAL-CTR.

- AUTO-FIX                      Automatic settings (FIX type)
- MANUAL-FIX                  Manual settings (FIX type)
- AUTO-CTR                     Automatic settings (CENTER type)
- MANUAL-CTR                 Manual settings (CENTER type)
- PIT                              Automatic settings (PIT type)

### Note

- If AUTO-FIX, AUTO-CTR, or PIT is selected, the NOISE AREA and MASK AREA parameters are set automatically according to the measured waveform. FITTING ALGO is set to LINEAR.
- See appendix 4, "WDM Analysis Function" for a description of the WDM analysis algorithms and parameters.

**FITTING ALGO**

This parameter is used to select the interpolation algorithm for determining the noise level.

This parameter is only set when NOISE ALGO is set to MANUAL-FIX or MANUAL-CTR.

**Interpolation algorithms**

Fitting Algorithm	Description
LINER	Linear interpolation
GAUSS	Normal distribution curve
LORENZ	Lorenz curve
3RD POLY	3rd polynomial
4TH POLY	4th polynomial
5TH POLY	5th polynomial

**Note**

If NOISE ALGO is AUTO-FIX or AUTO-CTR, then FITTING ALGO is automatically set to LINEAR and does not need to be set manually.

---

**NOISE AREA**

This parameter is used to set the range of waveform data to be used in determining the noise level through interpolation.

This parameter is only set when NOISE ALGO is set to MANUAL-FIX.

**MASK AREA**

This parameter is used to set the range of signal light to be masked when determining the noise level through interpolation.

This parameter is only set when FITTING ALGO is not set to LINEAR.

**NOISE BW**

This parameter is used to set the noise bandwidth.

**DUAL TRACE**

This parameter is used to turn the dual trace function ON/OFF.

When the dual trace function is used, the signal level and noise level during SNR measurement can each be determined from different traces.

## Parameter Settings for Analysis Results Display

These parameters are set with respect to the display format for displaying analysis results on the screen.

### DISPLAY TYPE

This parameter is used to select the analysis results display format.

#### Display Type Settings

DISPLAY TYPE	Description and Procedure
ABSOLUTE (Absolute value display)	<ol style="list-style-type: none"> <li>Set CH RELATION as OFFSET or SPACING.            OFFSET: Displays the relative value, channel to the reference channel.            SPACING: Displays the wavelength difference and level difference compared to the following adjacent channel.</li> <li>If OFFSET is selected, the reference channel is set through "REF CH".               <ul style="list-style-type: none"> <li>If the highest channel is used as a reference Set to HIGHEST.</li> <li>If any desired channel is used as a reference Set the reference channel number in "****CH".</li> </ul> </li> </ol>
RELATIVE (Relative value display relative to grid)	There are no setting fields for this display type. (See appendix 1, "WDM Wavelength GRID Table" for information on changing the grid table. )
DRIFT(MEAS) (Drift display using past measurement wavelength as a reference)	<p>The procedure for this display type varies depending on the reference.</p> <ul style="list-style-type: none"> <li>Press the MAX/MIN RESET key if you want to use the waveform data of the current active trace as a reference.</li> <li>To change the measurement conditions and set the initially measured waveform as the reference</li> </ul> <p>There are no parameter setting items since the data that was measured first becomes the reference.</p>
DRIFT(GRID) (Drift display using grid wavelength as a reference)	<p>The procedure for this display type varies depending on the reference.</p> <ul style="list-style-type: none"> <li>Press the MAX/MIN RESET key if you want to use the waveform data of the current active trace as a reference.</li> <li>To change the measurement conditions and set the initially measured waveform as the reference</li> </ul> <p>There are no parameter setting items since the data that was measured first becomes the reference.</p> <p>(See appendix 1, "WDM Wavelength GRID Table" for information on changing the grid wavelength.)</p>

**OUTPUT SLOPE**

Displays the least square approximation line passing through the detected channel peak. The channel slope can be obtained as a numerical value.

OUTPUT RESULTS of analysis results

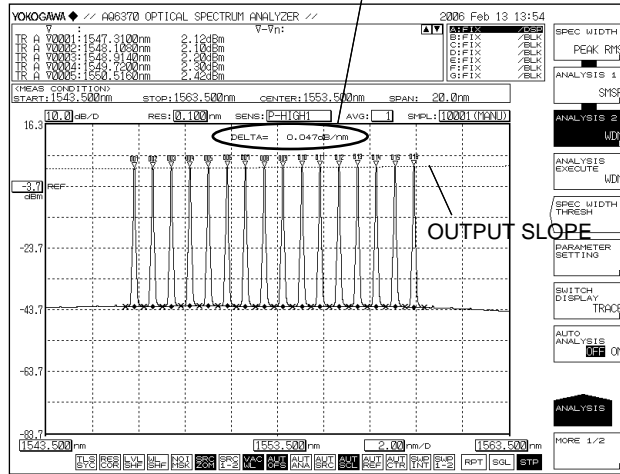

**POINT DISPLAY**

This parameter is used to display the range of data used in interpolation for determining the noise level.

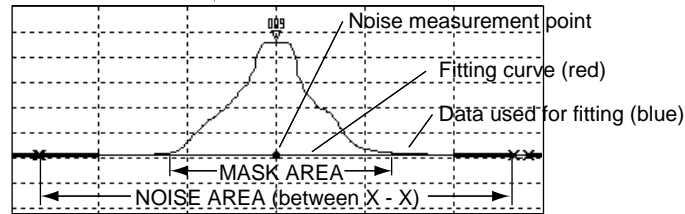
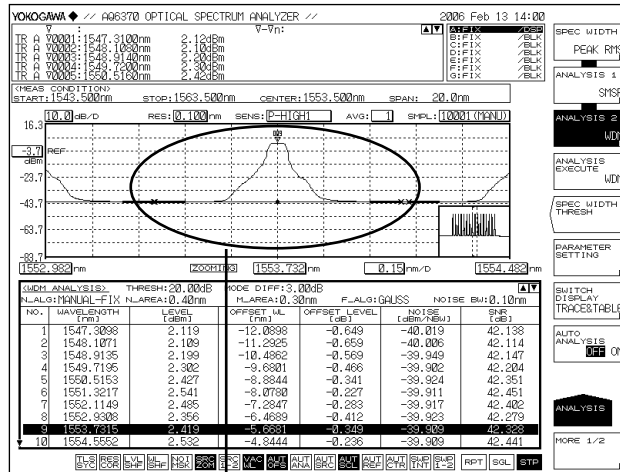

## 7.8 Optical Amp Gain and NF Measurement

### Procedure

Measurement can be performed of the optical amp gain and noise figure from the measured waveform of the signal light going into the optical amp, and the measured waveform of the output light leaving the optical amp.

1. Press **ANALYSIS**. The soft key menu for analyzing measured waveforms appears.
2. Press the **ANALYSIS 2** soft key. The analysis function selection menu is displayed.
3. Press the **EDFA-NF** soft key. Analysis is performed, and the results are displayed in a list. The analysis results display screen is switched with the **SWITCH DISPLAY** soft key.

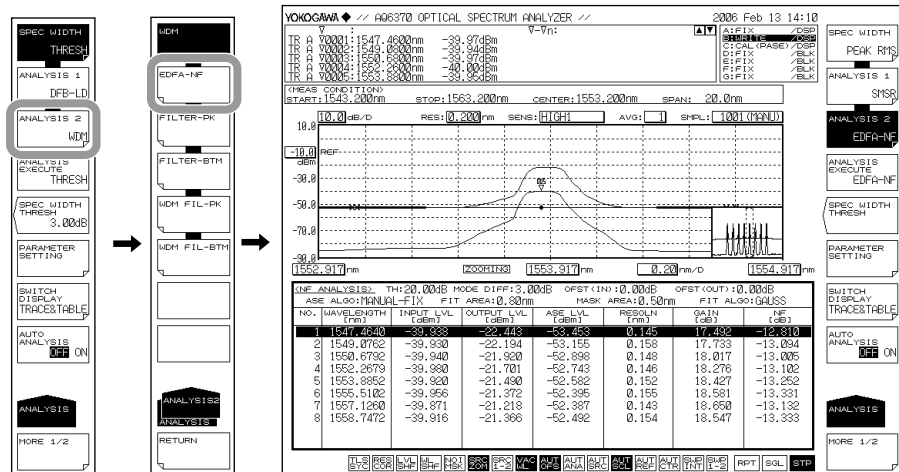

### Note

When zooming a waveform, if you click in the list of analysis results, the waveform of the selected channel is displayed in the center of the waveform screen.

## 7.8 Optical Amp Gain and NF Measurement

When changing the analysis parameters

4. Continuing on from step 3, press the **PARAMETER SETTING** soft key. The EDFA-NF analysis parameter setting screen is displayed.
5. Move the cursor with the arrow keys or soft keys, and enter a setting value with the numeric key pad. To select a check box, align the cursor then press the **SELECT** soft key.
6. Press the **CLOSE WINDOW** soft key. The EDFA-NF analysis parameter setting screen closes, and the soft key menu returns to the previous stage.
7. Press the **ANALYSIS EXECUTE** soft key. Analysis is performed according to the changed parameters, and the results are displayed in a list.

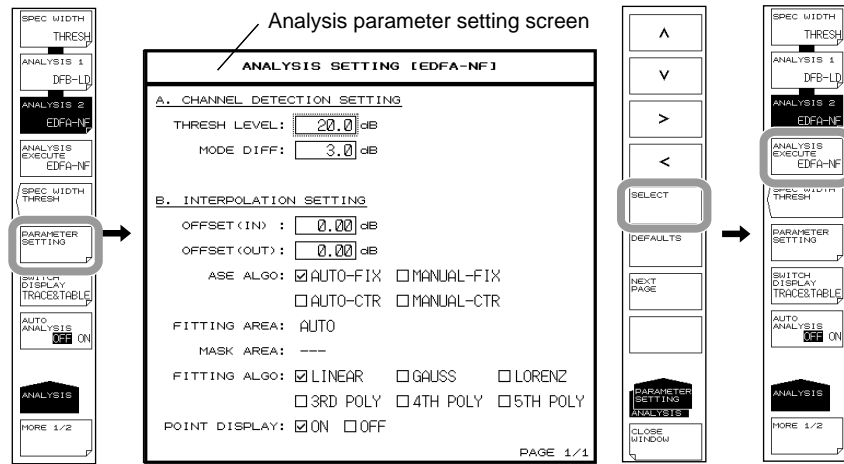

### Note

See appendix 5, "Optical Amp Analysis Function" for a description of the optical amp analysis algorithms and parameters.

Analysis of optical amp gain and NF is performed after measuring the signal light going into the optical amp and the output light leaving the optical amp.

### Acquiring Waveforms Required for Analysis

The following configuration and general procedure is used to measure optical amp gain and NF.

#### Signal light measurement configuration

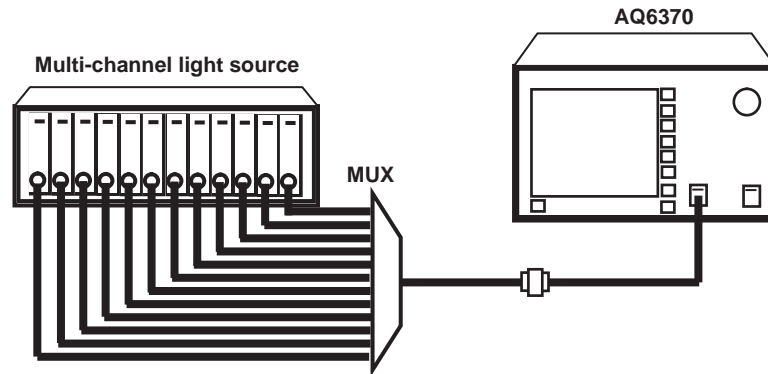

#### Output light measurement configuration

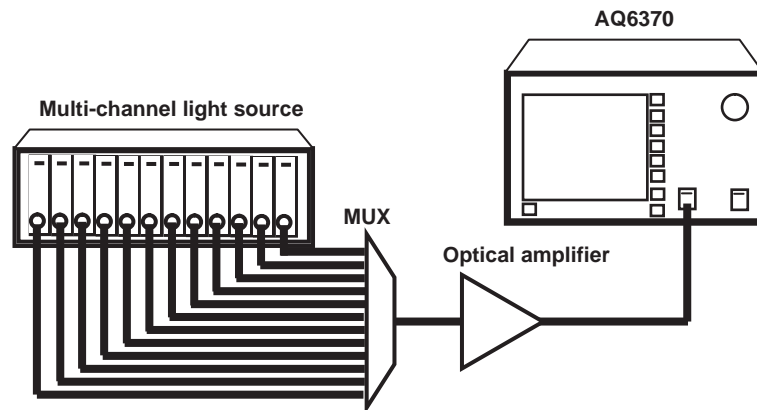

### Writing the Waveform of the Signal Light Input to the Optical Amp on Trace A

1. Input the signal light sent to the optical amp into the instrument.
2. Press **TRACE** followed by the **ACTIVE TRACE** soft key, then select A.
3. Press the **VIEW A** soft key and select **DISP**.
4. Press the **WRITE A** soft key. Trace A enters write mode.
5. Measure the signal light waveform according to measurement conditions matching the signal light waveform.  
(For details on the measuring procedure, see chapter 5, "Measurement.")
6. Press the **FIX A** soft key under **TRACE**. Trace A enters fixed mode.

#### Note

If all traces from trace A to trace G have been set to fix mode (FIX) as a result of this action, a warning is displayed. However, this does not pose a problem because trace B is set to write mode in the next step.

## 7.8 Optical Amp Gain and NF Measurement

### Writing the Waveform of the Output Light from the Optical Amp to Trace B

7. Input the light output from the optical amp into the instrument.
8. Press **TRACE** followed by the **ACTIVE TRACE** soft key, then select **B**.
9. Press the **VIEW B** soft key and select **DISP**.
10. Press the **WRITE B** soft key. Trace **B** enters write mode.
11. Measure the waveform of the output light with the same measurement conditions used for measuring the signal light waveform.

Examples of signal and output light waveforms

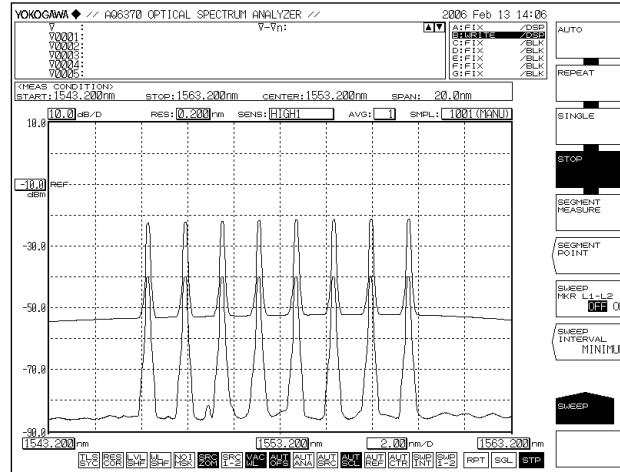

## Explanation

### Setting EDFA-NF Analysis Parameters

The EDFA-NF analysis function parameters may be broadly divided into the following two configurations.

Parameter settings may be changed as desired according to the details of the particular analysis.

- Parameters related to channel detection (CHANNEL DETECTION SETTING)
- ASE level measurement (INTERPOLATION SETTING).

Below is an explanation of each.

See appendix 3, "Analysis Function Details" for a description of the parameters.

### Parameter Settings Related to Channel Detection

These parameters are used to set the threshold level and the like for WDM channel detection.

#### THRESH LEVEL

This parameter is used to set the threshold level for channel detection.

This setting determines how far down in decibels from the peak level to detect a mode peak as a channel.

#### MODE DIFF

This parameter sets the minimum value for the peak/bottom difference during channel peak detection.

If the waveform peak/bottom difference equals or exceeds this value, it is detected as a mode peak.

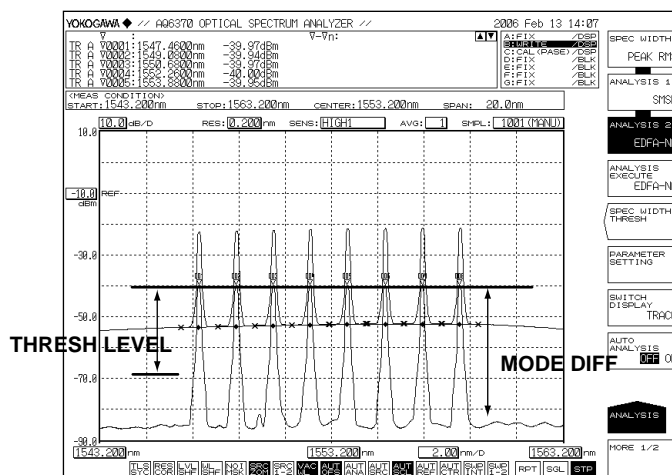

### Parameters Related to ASE Level Measurement

These parameters are used to set the waveform level, offset, and interpolation method for ASE level measurement.

#### OFFSET(IN)

A level offset can be set on a signal light waveform (trace A).

Set "0.00" if a level offset is not needed.

#### OFFSET(OUT)

A level offset can be set on an output light waveform (trace B).

Set "0.00" if a level offset is not needed.

#### ASE ALGO

Select one of the four algorithms shown below for measuring the ASE level. If AUTO-FIX or AUTO-CTR is set, the measurement parameters at another ASE level are set automatically. To set the values manually, select MANUAL-FIX or MANUAL-CTR.

- AUTO-FIX            Automatic settings (FIX type)
- MANUAL-FIX        Manual setting (FIX type)
- AUTO-CTR          Automatic setting (CENTER type)
- MANUAL-CTR        Manual setting (CENTER type)

#### **Note**

---

- If AUTO-FIX or AUTO-CTR is selected, the FITTING AREA and MASK AREA parameters are set automatically according to the measured waveform. FITTING ALGO is set to LINEAR.
  - See appendix 5, "Optical Amp Analysis Function" for a description of the parameters.
- 

#### FITTING ALGO

This parameter is used to select the interpolation algorithm for determining the ASE level. This parameter is only set when "ASE ALGO" is set to MANUAL-FIX or MANUAL-CTR.

Interpolation algorithms

Fitting Algorithm	Description
LINER	Linear interpolation
GAUSS	Normal distribution curve
LORENZ	Lorenz curve
3RD POLY	3rd polynomial
4TH POLY	4th polynomial
5TH POLY	5th polynomial

---

#### **Note**

---

- If NOISE ALGO is AUTO-FIX or AUTO-CTR, then FITTING ALGO is automatically set to LINEAR and does not need to be set manually.
- 

#### FITTING AREA

This parameter is used to set the range of waveform data to be used in determining the ASE level through interpolation.

This parameter is only set when "ASE ALGO" is set to MANUAL-FIX.

### MASK AREA

This parameter is used to set the range of signal light to be masked when determining the ASE level through interpolation.

This parameter is only set when "FITTING ALGO" is not set to LINEAR.

### POINT DISPLAY

This parameter is used to display the range of data used in interpolation for determining the noise level.

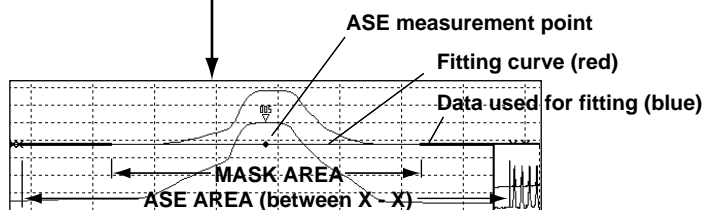
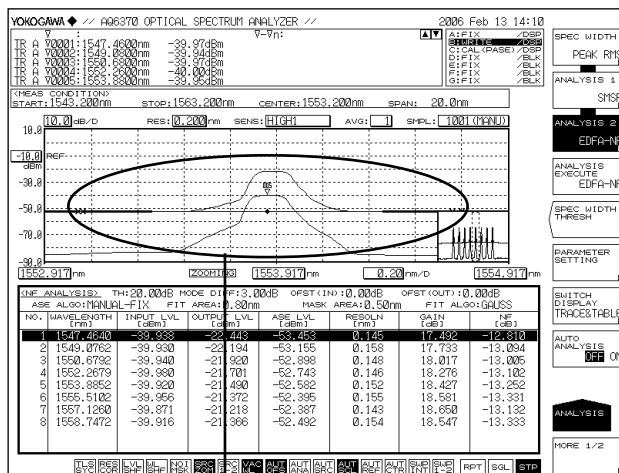

## 7.9 Optical Filter Characteristics Measurement

### Procedure

Optical filter characteristics can be measured from the measured waveform of the light input to the optical filter from the light source, as well as from the measured waveform light output from the optical filter.

### Filter Measurement (Single Channel)

You can analyze a waveform whose number of modes is 1.

#### Filter Peak Analysis

1. Press **ANALYSIS**. The soft key menu for analyzing measured waveforms appears.
2. Press the **ANALYSIS 2** soft key. The analysis function selection menu is displayed.
3. Press the **FILTER-PK** soft key. Analysis is performed, and the results are displayed in the data area.

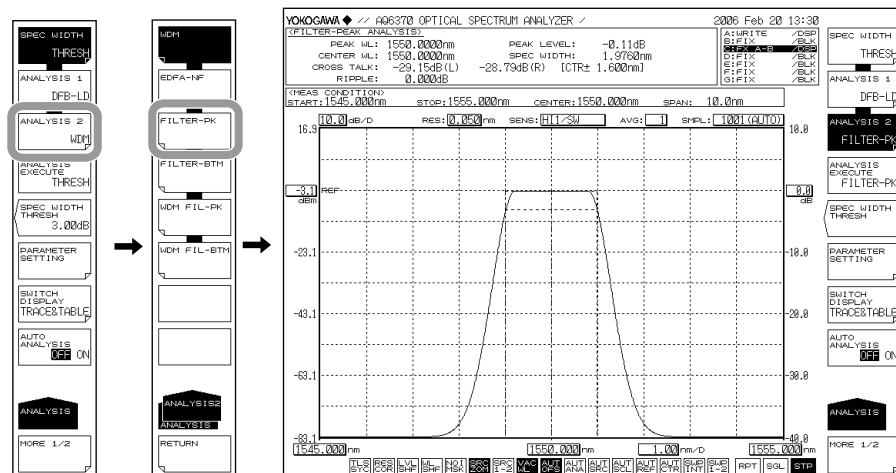

When changing the analysis parameters

4. Continuing on from step 3, press the **PARAMETER SETTING** soft key. The FILTER-PK analysis parameter setting screen is displayed. If a setting screen has multiple pages, press the **NEXT PAGE** soft key to display the next screen.
5. Move the cursor with the arrow keys or soft keys, and enter a setting value with the numeric key pad. To select a check box, align the cursor then press the **SELECT** soft key.
6. Press the **CLOSE WINDOW** soft key. The FILTER-PK analysis parameter setting screen closes, and the soft key menu returns to the previous stage.
7. Press the **ANALYSIS EXECUTE** soft key. Analysis is performed according to the changed parameters, and the results are displayed in a list.

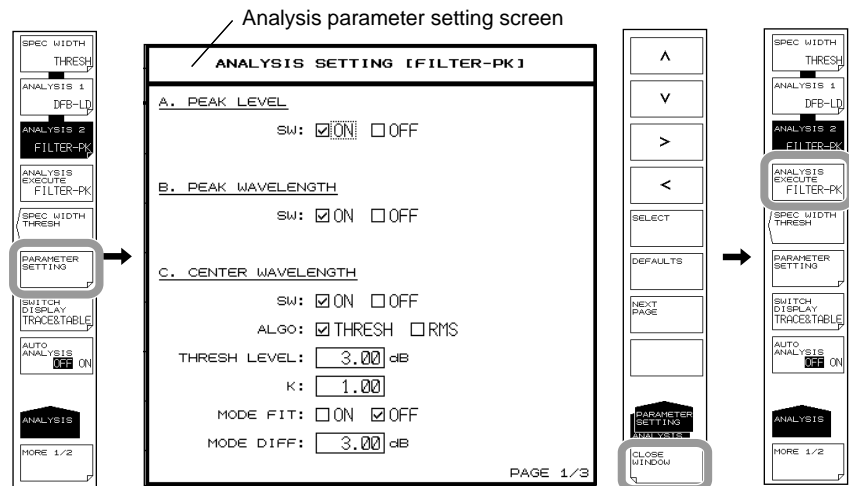

### Note

See appendix 6, "Optical Filter Analysis Function" for a description of the optical filter analysis algorithms and parameters.

### Filter Bottom Analysis

This is used if the optical filter is of a notch type rather than a pass band type.

1. Press **ANALYSIS**. The soft key menu for analyzing measured waveforms appears.
2. Press the **ANALYSIS 2** soft key. The analysis function selection menu is displayed.
3. Press the **FILTER-BTM** soft key. Analysis is performed, and the results are displayed in the data area.

When changing the analysis parameters

4. Continuing on from step 3, press the **PARAMETER SETTING** soft key. The FILTER-BTM analysis parameter setting screen is displayed. If a setting screen has multiple pages, press the **NEXT PAGE** soft key to display the next screen.
5. Move the cursor with the arrow keys or soft keys, and enter a setting value with the numeric key pad. To select a check box, align the cursor then press the **SELECT** soft key.
6. Press the **CLOSE WINDOW** soft key. The FILTER-BTM analysis parameter setting screen closes, and the soft key menu returns to the previous stage.
7. Press the **ANALYSIS EXECUTE** soft key. Analysis is performed according to the changed parameters, and the results are displayed in a list.

### Note

See appendix 6, "Optical Filter Analysis Function" for a description of the optical filter analysis algorithms and parameters.

### Filter Measurement for WDM (Multi Channel)

You can analyze multi-mode waveforms.

#### WDM Filter Peak Analysis

1. Press **ANALYSIS**. The soft key menu for analyzing measured waveforms appears.
2. Press the **ANALYSIS 2** soft key. The analysis function selection menu is displayed.
3. Press the **WDM FILTER-PK** soft key. Analysis is performed, and the results are displayed in a list. The analysis results display screen is switched with the **SWITCH DISPLAY** soft key.

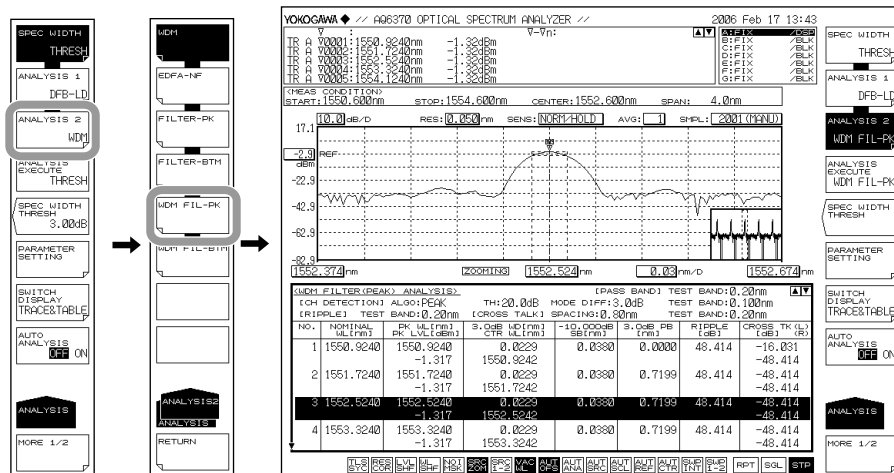

**Note**

When zooming a waveform, if you click in the list of analysis results, the waveform of the selected channel is displayed in the center of the waveform screen.

When changing the analysis parameters

4. Continuing on from step 3, press the **PARAMETER SETTING** soft key. The WDM FIL-PK analysis parameter setting screen is displayed. If a setting screen has multiple pages, press the **NEXT PAGE** soft key to display the next screen.
5. Move the cursor with the arrow keys or soft keys, and enter a setting value with the numeric key pad. To select a check box, align the cursor then press the **SELECT** soft key.
6. Press the **CLOSE WINDOW** soft key. The WDM FIL-PK analysis parameter setting screen closes, and the soft key menu returns to the previous stage.
7. Press the **ANALYSIS EXECUTE** soft key. Analysis is performed according to the changed parameters, and the results are displayed in a list.

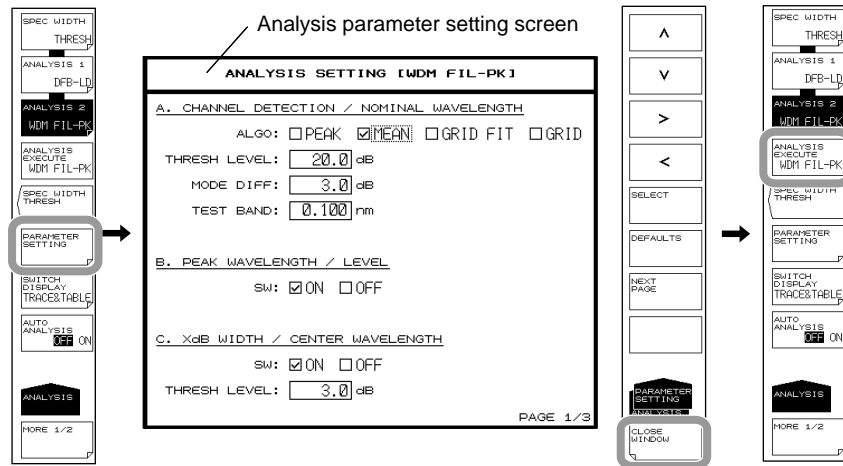
**Note**

See appendix 6, "Optical Filter Analysis Function" for a description of the optical filter analysis algorithms and parameters.

**WDM Filter Bottom Analysis**

This is used if the optical filter is of a notch type rather than a pass band type.

1. Press **ANALYSIS**. The soft key menu for analyzing measured waveforms appears.
2. Press the **ANALYSIS 2** soft key. The analysis function selection menu is displayed.
3. Press the **WDM FIL-BTM** soft key. Analysis is performed, and the results are displayed in a list. The analysis results display screen is switched with the **SWITCH DISPLAY** soft key.

**Note**

When zooming a waveform, if you click in the list of analysis results, the waveform of the selected channel is displayed in the center of the waveform screen.

When changing the analysis parameters

4. Continuing on from step 3, press the **PARAMETER SETTING** soft key. The WDM FIL-BTM analysis parameter setting screen is displayed. If a setting screen has multiple pages, press the **NEXT PAGE** soft key to display the next screen.
5. Move the cursor with the arrow keys or soft keys, and enter a setting value with the numeric key pad. To select a check box, align the cursor then press the **SELECT** soft key.
6. Press the **CLOSE WINDOW** soft key. The WDM FIL-BTM analysis parameter setting screen closes, and the soft key menu returns to the previous stage.
7. Press the **ANALYSIS EXECUTE** soft key. Analysis is performed according to the changed parameters, and the results are displayed in a list.

**Note**

See appendix 6, "Optical Filter Analysis Function" for a description of the optical filter analysis algorithms and parameters.

## 7.9 Optical Filter Characteristics Measurement

First measure the waveform of the wideband light source as a reference waveform, then subtract the WDM optical filter's output waveform from the reference waveform to measure the characteristics of the WDM optical filter.

### Acquiring Waveforms Required for Analysis

The following configuration and general procedure is used to measure WDM optical filter characteristics.

A pass band type WDM optical filter is used as an example.

#### Reference spectrum

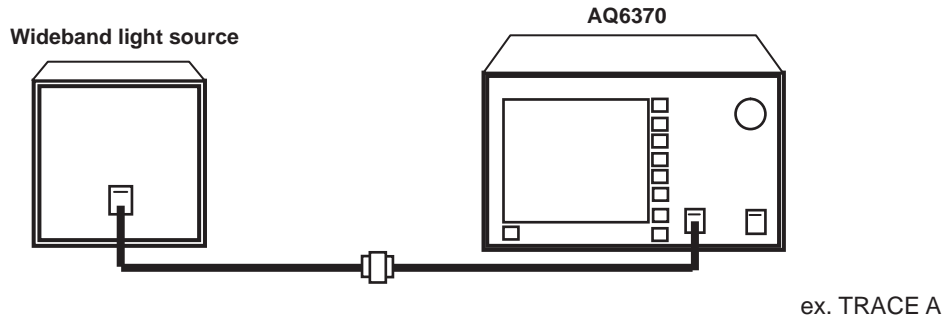

#### Spectrum measurement after passing through the filter

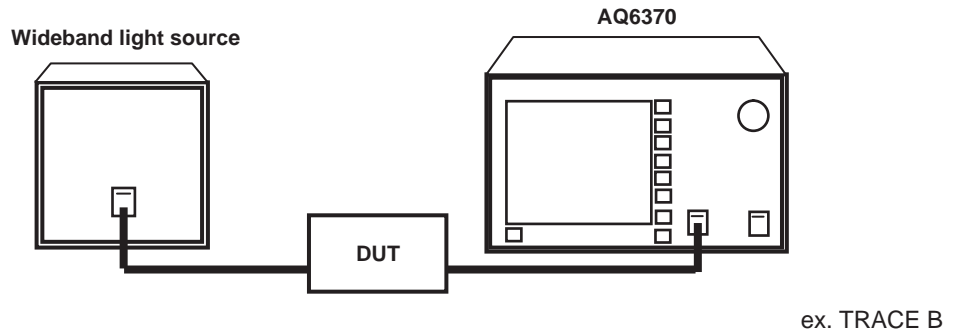

### Writing the Waveform of the Light Source Input to the Optical Filter on Trace A

1. Input the emitted light from the light source that is input to the optical filter into the instrument.
2. Press **TRACE** followed by the **ACTIVE TRACE** soft key, then select A.
3. Press the **VIEW A** soft key and select **DISP**.
4. Press the **WRITE A** soft key. Trace A enters write mode.
5. Measure the light source waveform according to measurement conditions matching the light source waveform.  
(For details on the measuring procedure, see chapter 5, "Measurement.")
6. Press the **FIX A** soft key under **TRACE**. Trace A enters fixed mode.

#### **Note**

If all traces from trace A to trace G have been set to fix mode (FIX) as a result of this action, a warning is displayed. However, this does not pose a problem because trace B is set to write mode in the next step.

### Writing the Waveform of the Output Light from the Optical Filter to Trace B

1. Input the emitted light from the light source to the optical filter, then input the light that is output from the optical filter into the instrument.
2. Press **TRACE** followed by the **ACTIVE TRACE** soft key, then select B.
3. Press the **VIEW B** soft key and select **DISP**.
4. Press the **WRITE B** soft key. Trace B enters write mode.
5. Measure the waveform of the output light with the same measurement conditions used for measuring the light source waveform.

### Writing the Difference between Traces to Trace C

2. Press **TRACE** followed by the **ACTIVE TRACE** soft key, then select C.
3. Press the **VIEW C** soft key and select **DISP**.
4. Press the **CALCULATE C** soft key.
5. Press the **LOG MATH** soft key. The math function selection menu is displayed.
6. Press the **C = A-B (LOG)** soft key. The waveform which is obtained by subtracting the trace B waveform from the trace A waveform is displayed on trace C.

**Explanation**

**Setting WDM Filter Analysis Parameters**

The WDM FIL-PK analysis function parameters may be broadly divided into the two types shown below.

Parameter settings may be changed as desired according to the details of the particular analysis.

- Parameters related to channel detection
- Parameter settings for each analysis item

The following is an explanation of each of the parameters.

See appendix 6, "Optical Filter Analysis Function" for a description of the parameters.

**Parameter Settings Related to Channel Detection**

These parameters are used to set algorithms and threshold level for WDM channel detection.

**ALGO**

Depending on the selected algorithm, select one of the following four algorithms for WDM channel detection and reference wavelength analysis on each channel.

- PEAK
- MEAN
- GRID FIT
- GRID

The channel detection and reference wavelength analysis results for each channel vary depending on the algorithm selected.

- **When PEAK is selected**

Each mode peak is detected as a channel.

The peak wavelength of each channel is the reference wavelength.

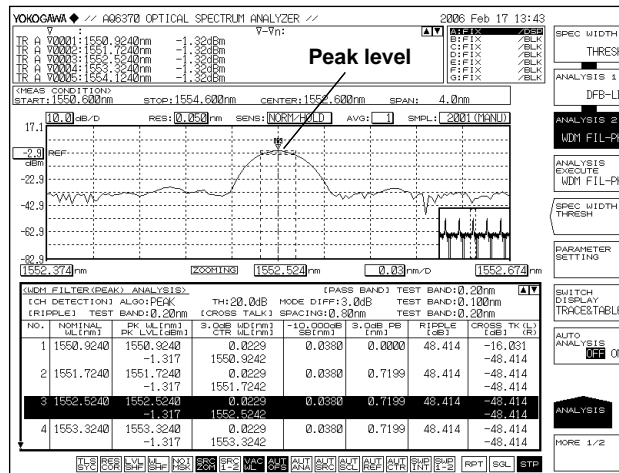

- **When MEAN is selected**  
 Each mode peak is detected as a channel.  
 The 3dB center wavelength of each channel is the reference wavelength.

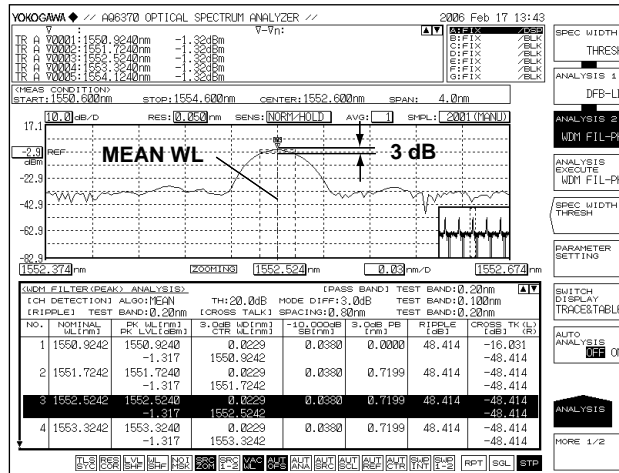

- **When GRID FIT is selected**  
 The mode peak detected within GRID WL [PLUSMINUS SYMBOL] (TEST BAND/2) is set as the channel.  
 The GRID wavelength nearest to each channel is the reference wavelength.

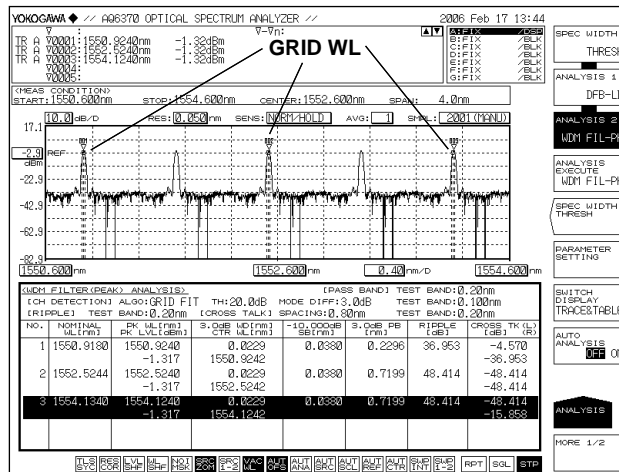

## 7.9 Optical Filter Characteristics Measurement

- **When GRID is selected**  
 The wavelengths registered in the GRID table wavelength are recognized as channels.  
 GRID WL is set as the reference wavelength.

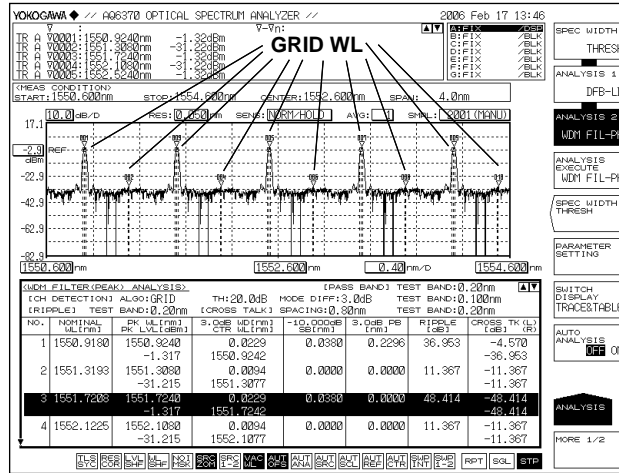

### THRESH LEVEL

This parameter is used to set the threshold level for channel detection.

### MODE DIFF

This parameter sets the minimum value for the peak/bottom difference during channel peak detection.

### TEST BAND

This parameter is used to set the bandwidth for reference wavelength analysis.

## Parameter Settings for the Analysis Items

These parameters are set for each WDM optical filter analysis item.

The analysis parameter setting screen is displayed.

### Note

See appendix 6, "Optical Filter Analysis Function" for a description of the optical filter analysis algorithms and parameters.

## 7.10 Editing the Grid Table

### Procedure

#### Editing a Standard Grid Table

1. Press **SYSTEM**.
2. Press the **GRID EDITOR** soft key. The Grid table edit screen appears.

#### Setting the Frequency Spacing

3. Press one of the keys from **200 GHz SPACING** to **12.5 GHz SPACING**. Depending on the selected soft key, a frequency spacing table of 200 GHz, 100 GHz, 50 GHz, 25 GHz, or 12.5 GHz can be used.

#### Setting the Reference Wavelength

4. Press the **REFERENCE WAVELENGTH** soft key. A screen for specifying the standard wavelength is displayed.
5. Enter the standard wavelength using the rotary knob or arrow keys, then press **nm/ENTER**.

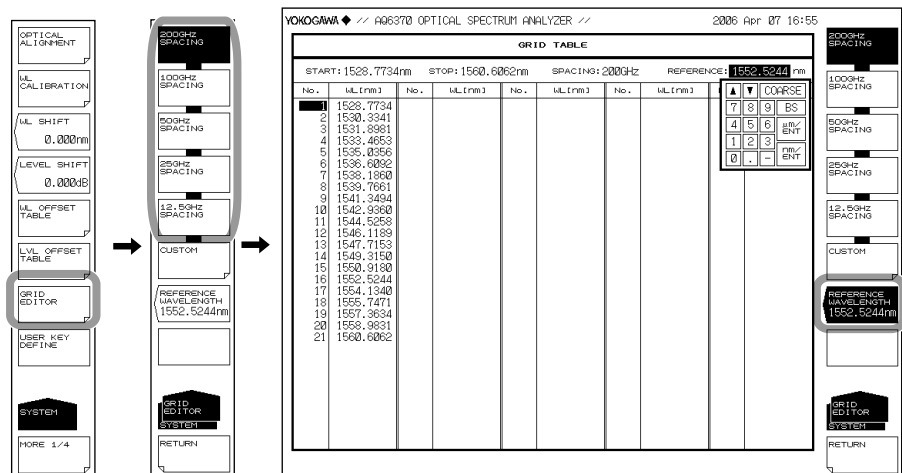

### Editing a Custom Grid Table

1. Press **SYSTEM**.
2. Press the **GRID EDITOR** soft key. The Grid table edit screen appears.
3. Press the **CUSTOM** soft key. The custom Grid table edit screen appears.

### Setting the Start/Stop Wavelength

4. Press the **START WL** or **STOP WL** soft key. A screen for specifying the start or stop wavelength is displayed.
5. Enter the start or stop wavelength using the rotary knob or arrow keys, then press **nm/ENTER**.

### Setting the Frequency Spacing

6. Press the **SPACING** soft key. A screen for specifying the frequency spacing is displayed.
7. Enter the frequency spacing using the rotary knob or arrow keys, then press **nm/ENTER**.
8. Press the **EXECUTE** soft key. The settings entered up to this point are finalized, and the previous menu is displayed allowing setting of the reference wavelength.

YOKOGAWA // A66370 OPTICAL SPECTRUM ANALYZER // 2006 Apr 07 16:59

**GRID TABLE**

START: 1528.7734 nm STOP: 1560.6062 nm SPACING: 50.0 GHz REFERENCE: 1552.5244nm

No.	W.L.(nm)	No.	W.L.(nm)	No.	W.L.(nm)	No.	W.L.(nm)
1	1528.7734	31	1540.5573	61	1552.5244		
2	1529.1633	32	1540.9533	62	1552.9203		
3	1529.5534	33	1541.3494	63	1553.3163		
4	1529.9436	34	1541.7457	64	1553.7123		
5	1530.3341	35	1542.1423	65	1554.1084		
6	1530.7248	36	1542.5390	66	1554.5044		
7	1531.1157	37	1542.9360	67	1554.9011		
8	1531.5068	38	1543.3331	68	1555.2975		
9	1531.8981	39	1543.7305	69	1555.6941		
10	1532.2896	40	1544.1280	70	1556.0908		
11	1532.6813	41	1544.5256	71	1556.4878		
12	1533.0732	42	1544.9233	72	1556.8849		
13	1533.4653	43	1545.3213	73	1557.2821		
14	1533.8575	44	1545.7195	74	1557.6795		
15	1534.2500	45	1546.1189	75	1558.0771		
16	1534.6427	46	1546.5177	76	1558.4749		
17	1535.0356	47	1546.9167	77	1558.8729		
18	1535.4287	48	1547.3159	78	1559.2711		
19	1535.8220	49	1547.7153	79	1559.6695		
20	1536.2155	50	1548.1149	80	1560.0681		
21	1536.6092	51	1548.5146	81	1560.4668		
22	1537.0031	52	1548.9148				
23	1537.3972	53	1549.3150				
24	1537.7915	54	1549.7155				
25	1538.1860	55	1550.1161				
26	1538.5807	56	1550.5170				
27	1538.9757	57	1550.9180				
28	1539.3708	58	1551.3193				
29	1539.7661	59	1551.7208				
30	1540.1616	60	1552.1225				

### Setting the Reference Wavelength

9. Press the **REFERENCE WAVELENGTH** soft key. A screen for specifying the standard wavelength is displayed.
10. Enter the standard wavelength using the rotary knob or arrow keys, then press **nm/ENTER**.

### Note

- If this Grid Table is edited and then the **CANCEL** key is pressed without pressing the **EXECUTE** key, the edits made to the custom Grid table are canceled.
- Press the **EXECUTE** key to apply the edits in the custom Grid table to the analysis function.

### Setting Channel Point Wavelength

4. Continuing on from step 3, place the cursor on the channel point you wish to change using the rotary knob, arrow keys, or numeric key pad.
5. Press the **VALUE EDIT** soft key. The setting screen for changing the channel point wavelength is displayed.
6. Enter the wavelength using the rotary knob or arrow keys, then press **nm/ENTER**.

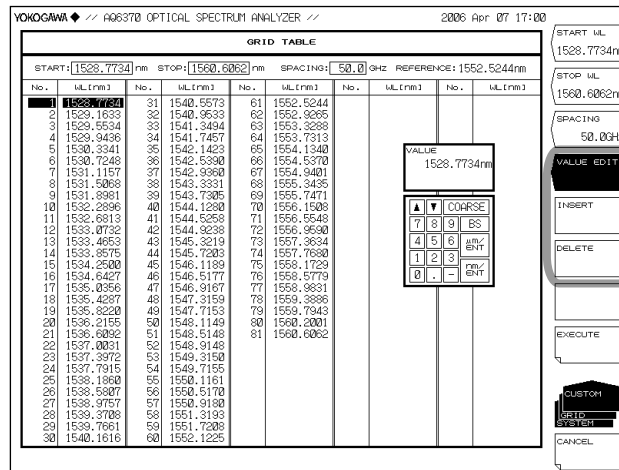

### Inserting Channel Points

4. Continuing on from step 3, place the cursor on the channel point you wish to insert using the rotary knob, arrow keys, or numeric key pad.
5. Press the **INSERT** soft key. A channel point having the same value as the wavelength of the cursor-selected channel point is inserted. Subsequent channel points are shifted down by one point.

### Deleting Channel Points

4. Continuing on from step 3, place the cursor on the channel point you wish to delete using the rotary knob, arrow keys, or numeric key pad.
5. Press the **DELETE** soft key. The channel point at the cursor is deleted. Subsequent channel points are shifted up by one point.

### Switching the Units of the Wavelength Axis on the Grid Table to Frequency

1. Press **MARKER**.
2. Press the **MORE** soft key twice. The MORE 3/3 key menu is displayed.
3. Press the **MARKER UNIT nm THz** soft key. Each time you press the soft key, the units toggle between nm and THz.

### Note

For a diagram of soft key operation, see section 6.8, "Displaying Markers."

### Explanation

#### Grid Table

A grid table lists wavelengths (frequencies) that are referenced by part of the analysis function when it is executed. There is a standard Grid table and a custom Grid table.

#### Standard Grid Table

This Grid table is created with pre-defined wavelength (frequency) ranges. It can be created in the following manner by setting the reference wavelength (frequency) and frequency spacing.

#### 200 GHz SPACING–12.5 GHz SPACING

Creates a grid table with 200 GHz–12.5 GHz grid spacing.

#### REFERENCE WAVELENGTH

Sets the grid table reference wavelength. This can be set in the range of 1000.0000 to 1700.0000 nm.

#### Custom Grid Table

Users can edit this Grid table freely.

It is created automatically by setting the start/stop wavelength (frequency), reference wavelength (frequency), and frequency spacing.

Users can add or delete an arbitrary channel to/from the created Grid table or edit wavelength (frequency) values for each channel there.

#### START WL

Sets the start wavelength.

#### STOP WL

Sets the stop wavelength.

#### SPACING

Sets the frequency spacing.

#### REFERENCE WAVELENGTH

Sets the grid table reference wavelength. This can be set in the range of 1000.0000 to 1700.0000 nm.

#### VALUE EDIT

You can edit channel points.

#### **Note**

---

For details on the Grid table, see appendix 1, "WDM Wavelength Grid Table."

---

## 7.11 Measurement of Level Fluctuations in Single-Wavelength Light (0 nm Sweeping)

### Procedure

This function measures changes over time in the level of a specific wavelength level. It is useful for purposes such as optical axis alignment when connecting an optical fiber to a light source. The following discussion pertains to an example in which the spatial light of an He-Ne gas laser (1152.274 nm) is input to an optical fiber.

#### Setting the Center Wavelength to 1152.274 nm

1. Press **CENTER**. The soft key menu for setting the center wavelength appears.
2. Press the **CENTER WL** soft key. The center wavelength setting screen is displayed.
3. Enter a center wavelength of 1152.274 nm using the rotary knob or numeric key pad.
4. Press **nm/ENTER**.

#### Setting the Resolution to 2.000 nm

5. Press **SETUP**. The soft key menu for sweep condition settings appears.
6. Press the **RESOLUTION** soft key. The resolution selection menu is displayed.
7. Press the **2.000nm** soft key.
8. Press **nm/ENTER**.

#### Setting the Sweep Width to 0 nm

9. Press **SPAN**. The soft key menu for setting the sweep width appears.
10. Press the **SPAN WL** soft key. The sweep width setting screen is displayed.
11. Enter a sweep width of 0 nm using the rotary knob or numeric key pad.
12. Press **nm/ENTER**. Set the sweep width to 0 nm. The measurement start wavelength, measurement center wavelength, and measurement stop wavelength are all set to 1152.274 nm.

#### Setting the Sweep Time

13. Press the **0 nm SWEEP TIME** soft key. A screen for specifying the sweep time is displayed.
14. Enter a numerical value using the rotary knob or numeric key pad, then press **nm/ENTER**.
15. Press **SWEEP**, followed by the **REPEAT** soft key. Sweeping begins.

## 7.11 Measurement of Level Fluctuations in Single-Wavelength Light (0 nm Sweeping)

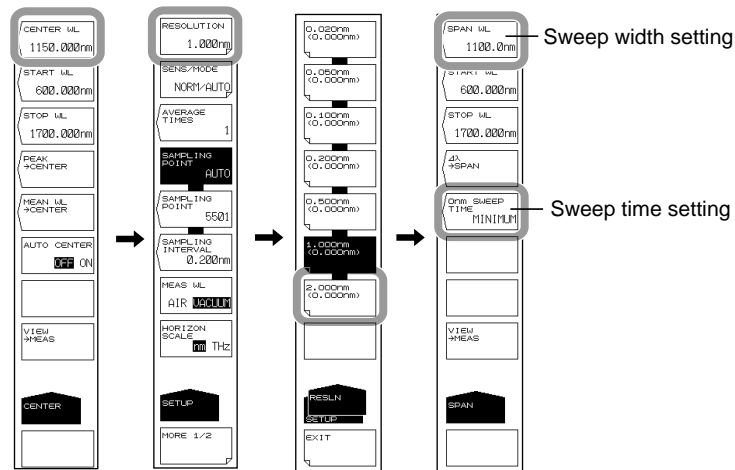

### Note

- When the sweep range is set to 0 nm, the horizontal axis is set as the time axis as a result.
- The sweeping time varies depending on the measurement sensitivity (SENS/MODE soft key under SETUP). If the setting for this key is less than the sweeping time for each sensitivity, the setting for the key is invalid and the MINIMUM setting is used.

**Explanation**

The following is the structure in which the spatial light of an He-Ne gas laser (1152.274 nm) is input to an optical fiber.

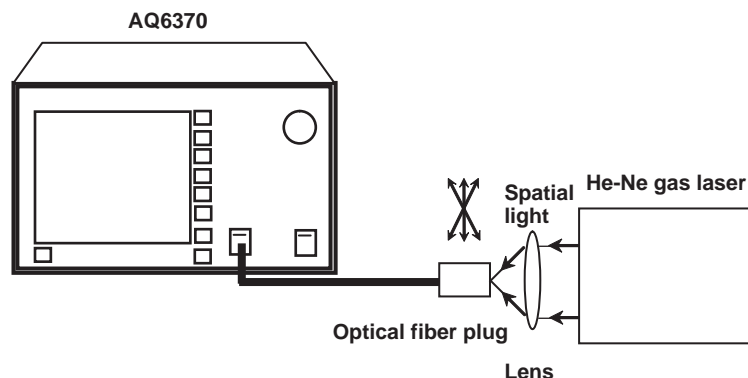

The sweep width is set to 0 nm, the center wavelength is fixed, and measurement of the single-wavelength light only is taken. Finely adjust the optical fiber plug while observing the displayed waveform so as to set the light source input level to the peak.

**0nm SWEEP TIME**

When the sweep width is 0 nm, the horizontal axis is set as the time axis. The time required to measure from the left edge to the right edge of the screen is set. The allowed settings are MINIMUM and the range of 1 to 50 s. The value changes in 1 s steps.

If you press the COARSE key, you can change the setting in 1-2-5 steps.

If 0 is entered, MINIMUM is shown on the display. Also, the sweeping time varies depending on the measurement sensitivity (SENS/MODE soft key under SETUP). If the setting for this key is less than the sweeping time for each sensitivity, the setting for the key is invalid and the MINIMUM setting is used. The sampling points are automatically set to 1001.

## 7.12 Go/No-Go Judgment (Template)

### Procedure

This function compares preset reference data (template data) with a measured waveform, and makes a Go/No-Go judgment.

#### Creating Template Data on the Instrument

1. Press **ADVANCE** followed by the **TEMPLATE** soft key.
2. Press the **TEMPLATE EDIT** soft key. The template creation screen is displayed.
3. Press the **LINE SELECT** soft key.
4. Press the soft key corresponding to the type of template you wish to create.  
 UPPER LINE: Upper limit line  
 LOWER LINE: Lower limit line  
 TARGET LINE: Target value line
5. Press the **MODE ABS/REL** soft key to select either ABS (absolute) or REL (relative) as the type (template data types).
6. Press the **EXTRAPOL TYPE** soft key to select the extrapolation method.  
 TYPE A: Extrapolation type A  
 TYPE B: Extrapolation type B  
 NONE: No extrapolation
7. To edit template data, move the cursor to the location of the data to be edited using the rotary knob or arrow keys, then press the **VALUE EDIT** soft key. Enter a value using the numeric key pad, rotary knob, or arrow keys.
8. To add template data, press the **INSERT** soft key. The data at the cursor location is added. Edit the value using the procedure in step 7 and set it as new data.
9. To delete template data, move the cursor to the location of the data to be deleted using the rotary knob or arrow keys, then press the **DELETE** soft key. To delete all template data points, press the **ALL DELETE** soft key.

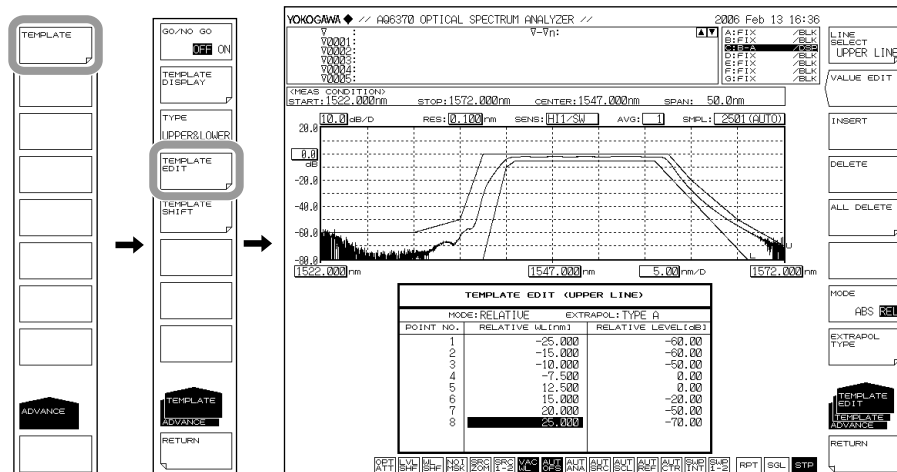

#### Note

- For information about extrapolation methods, see the explanation.
- The same wavelength/level data prior to insertion are inserted as data in the points that were inserted using the INSERT soft key.
- When the target line is turned OFF with the TEMPLATE DISPLAY soft key, if you edit the template data at the target line, the target line TEMPLATE DISPLAY turns ON.

## Executing Go/No Go Judgment

1. After creating or loading template data, press **ADVANCE** followed by the **TEMPLATE** soft key.
2. Press the **TYPE** soft key. The judgment condition setting menu is displayed.
3. Press the **UPPER**, **LOWER**, or **UPPER & LOWER** soft key once.
4. Press the **RETURN** soft key. The screen returns to the previous stage.
5. Press the **GO/NO GO** soft key to select ON. The judgment results are displayed on screen as PASS or FAIL.

## Loading Template Data

Load template data on the instrument.

1. Press **FILE**, followed by the **ITEM SELECT** soft key. The soft key menu for selecting the data type appears.
2. Press the **TEMPLATE** soft key.
3. Press the **READ** soft key.
4. Press the **FILE ->@@@** soft key. The load target line selection menu is displayed (where @@@ is the currently set contents).
5. Press the **UPPER LINE**, **LOWER LINE**, or **TARGET LINE** soft key once. The screen returns to the previous stage.
6. Move the cursor to the template data file to load from the file list, then press the **EXECUTE** soft key.

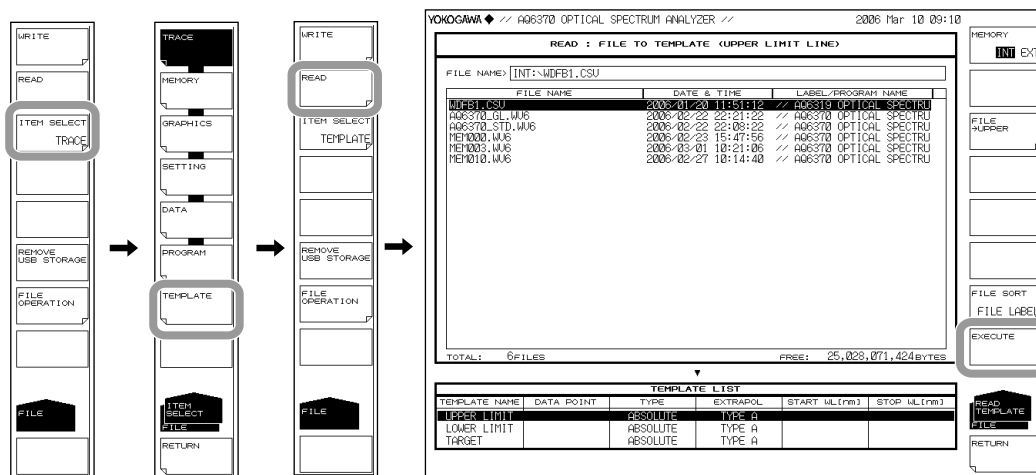

## Template Data Types

The following types of template data are available.

- CSV (comma delimited) files created on an external PC
- Waveform files of the instrument (.CSV or .BIN files)

### Note

- After loading data, WL SHIFT and LVL SHIFT in the template are set to zero.
- For information about data formats when creating template data on an external PC, see the Explanation subsection.

### Setting the Shift Amount and Shifting the Template

The template data wavelength/level can be shifted without changing the template data. The procedure for doing this is shown below.

1. Press **ADVANCE** followed by the **TEMPLATE** soft key.
2. Press the **TEMPLATE SHIFT** soft key. The shift item selection menu is displayed.
3. To shift the wavelength, press the **WL SHIFT \*\*\*\*.\*\*\*nm** soft key. To shift the level, press the **LEVEL SHIFT \*\*.\*dB** soft key.
4. Enter a shift amount using the rotary knob, arrow keys, or numeric key pad.

#### Note

- Use of this function does not change the template data.
- Use of this function does not query the template type. Both absolute and relative are supported.
- Shifts set by this function apply to all three line types (UPPER LIMIT LINE, LOWER LIMIT LINE, AND TARGET LINE). To shift just one line, edit the template data.

### Switching Absolute and Relative Value, and Shifting the Template

This function shifts the wavelength/level based on the template data ABSOLUTE/RELATIVE switching function. The template data themselves can be shifted by changing the ZOOM CENTER WL or REF LEVEL.

The following settings are an example.

- ZOOM CENTER WL: 1547.000 nm
- REF LEVEL: 0.00 dBm

### Creating a Template in ABSOLUTE Mode

TEMPLATE EDIT (UPPER LINE)		
MODE: ABSOLUTE		EXTRAPOL: TYPE A
POINT NO.	ABSOLUTE WL [nm]	ABSOLUTE LEVEL [dB]
1	1522.000	-60.00
2	1532.000	-60.00
3	1537.000	-50.00
4	1539.500	0.00
5	1559.500	0.00
6	1562.000	-20.00
7	1567.000	-50.00
8	1572.000	-50.00

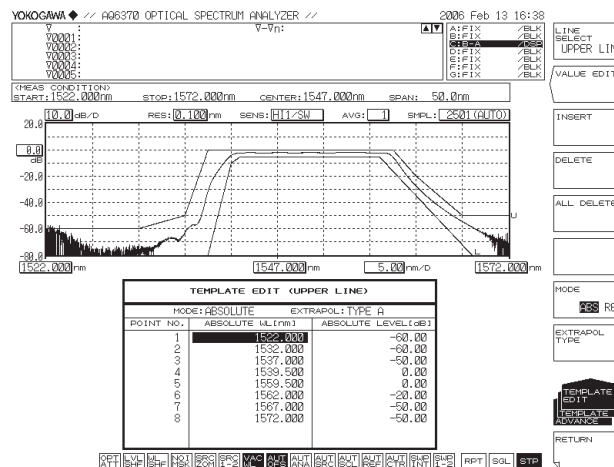

### Switching to RELATIVE Mode

1. Press **ADVANCE** followed by the **TEMPLATE** soft key.
2. Press the **TEMPLATE EDIT** soft key. The edit menu is displayed.
3. Press the **MODE ABS/REL** soft key to select **REL**. The instrument enters Relative mode.

TEMPLATE EDIT (UPPER LINE)		
MODE: RELATIVE		EXTRAPOL: NONE
POINT NO.	RELATIVE WL[nm]	RELATIVE LEVEL[dB]
1	-25.000	-60.00
2	-15.000	-60.00
3	-10.000	-50.00
4	-7.500	0.00
5	12.500	0.00
6	15.000	-20.00
7	20.000	-50.00
8	25.000	-50.00

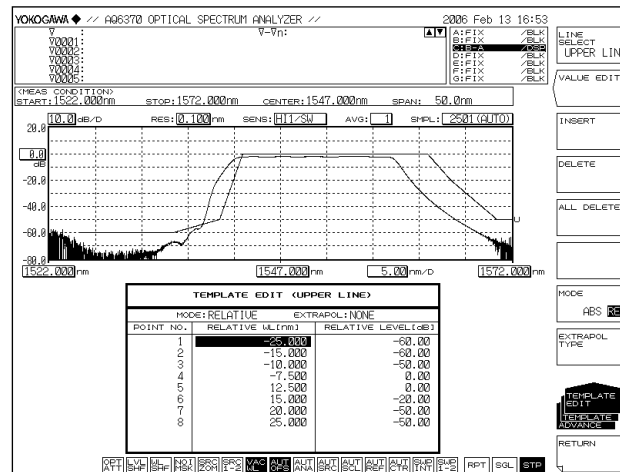

### Changing ZOOM CENTER WL and REF LEVEL

- ZOOM CENTER WL: 1544.000 nm
  - REF LEVEL: 10.00 dBm
4. Press **ZOOM**, followed by the **ZOOM CENTER WL** soft key.
  5. Enter 1544.000 using the rotary knob or arrow keys, then press **nm/ENTER**.
  6. Press **LEVEL**, followed by the **REF LEVEL** soft key.
  7. Enter 10.00 using the rotary knob or arrow keys, then press **nm/ENTER**.

TEMPLATE EDIT (UPPER LINE)		
MODE: RELATIVE		EXTRAPOL: NONE
POINT NO.	RELATIVE WL[nm]	RELATIVE LEVEL[dB]
1	-25.000	-60.00
2	-15.000	-60.00
3	-10.000	-50.00
4	-7.500	0.00
5	12.500	0.00
6	15.000	-20.00
7	20.000	-50.00
8	25.000	-50.00

The template relative value does not change after editing.

## 7.12 Go/No-Go Judgment (Template)

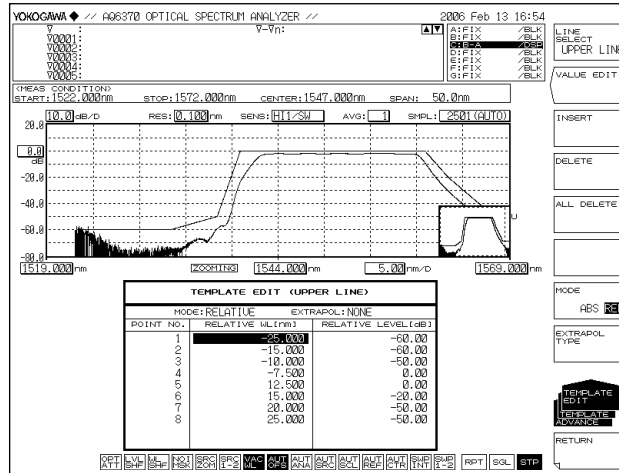

### Switching to ABSOLUTE Mode

8. Press **ADVANCE** followed by the **TEMPLATE** soft key.
9. Press the **TEMPLATE EDIT** soft key. The edit menu is displayed.
10. Press the **MODE ABS/REL** soft key, then select **ABS**. The instrument enters Absolute mode.

TEMPLATE EDIT (UPPER LINE)		
MODE: ABSOLUTE		EXTRAPOL: NONE
POINT NO.	ABSOLUTE WL [nm]	ABSOLUTE LEVEL [dB]
1	1519.000	-60.00
2	1529.000	-60.00
3	1534.000	-50.00
4	1536.500	0.00
5	1556.500	0.00
6	1559.000	-20.00
7	1564.000	-50.00
8	1569.000	-50.00

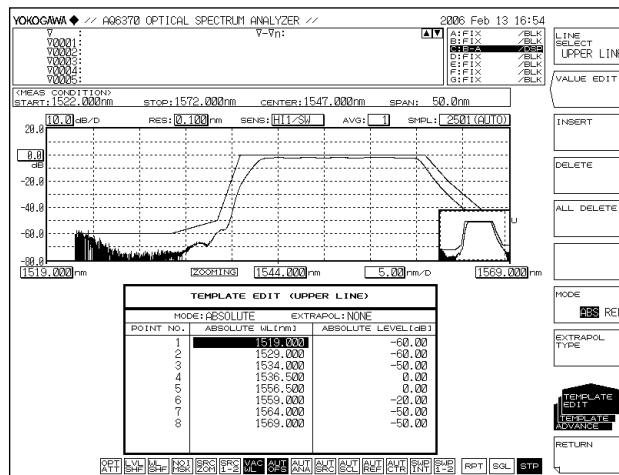

The results and template are shifted 3 nm to the left on screen.

### Turning the Template Data Display ON/OFF

1. Press **ADVANCE** followed by the **TEMPLATE** soft key.
2. Press the **TEMPLATE DISPLAY** soft key. The display ON/OFF switch menu is displayed.
3. Press the soft keys for each of the three lines (**UPPER LINE DISPLAY**, **LOWER LINE DISPLAY**, and **TARGET LINE DISPLAY**), and select ON or OFF. The selection changes each time you press the key.

#### **Note**

If the GO/NO GO soft key is set to ON, a Go/No Go test is performed according to the test type, even if the TEMPLATE DISPLAY soft key indicator is set to OFF.

**Explanation**

**Go/No Go Judgment**

The following are the three types of template.

- Upper limit line
- Lower limit line
- Target line

Upper and lower limit lines are used for Go/No Go judgment. For target line only, the function displays the targeted spectrum on the measurement screen without comparing it to the measured waveform.

**Upper Limit Line Judgment**

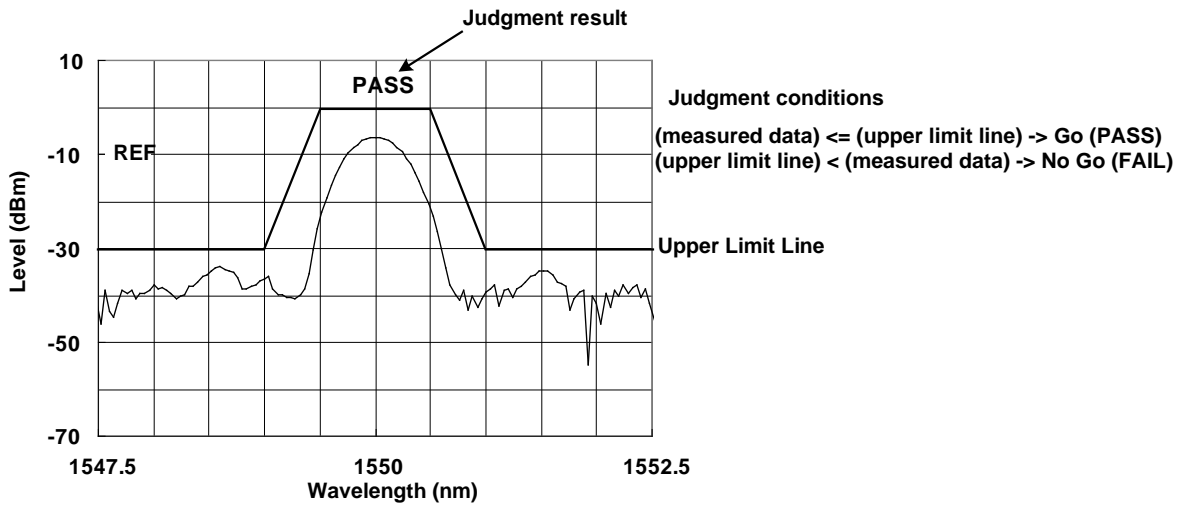

**Lower Limit Line Judgment**

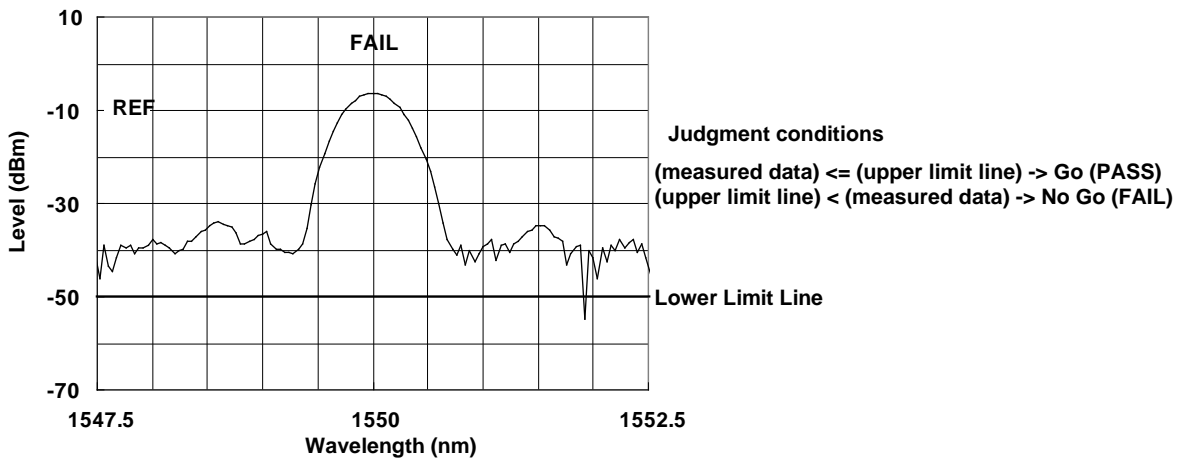

## Upper Limit Line and Lower Limit Line Judgment

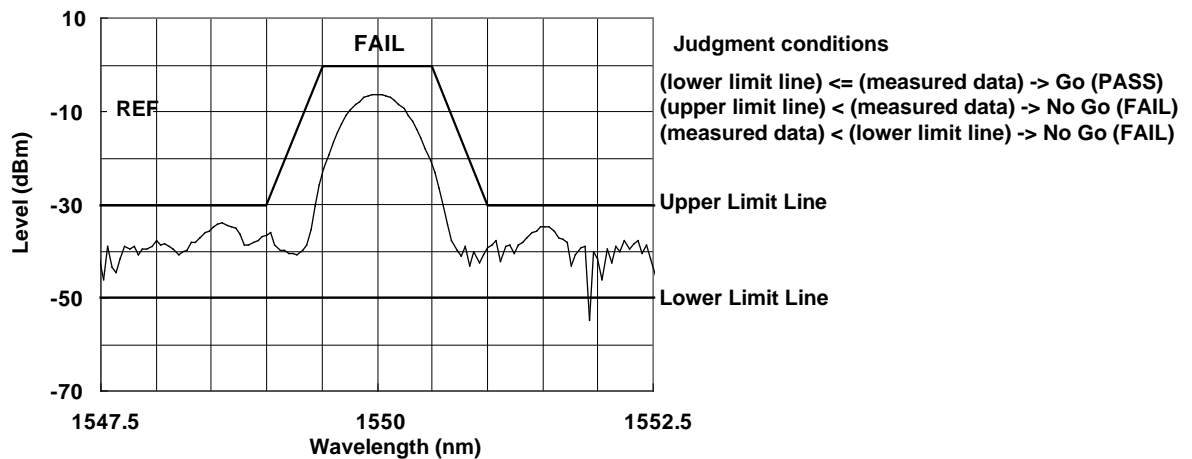
**Note**

- Go/No Go judgment is executed within the wavelength range shown on the screen.
- During execution, the line marker search (<SEARCH/ANA L1-L2> key) and zoom area search function (<SEARCH/ANA ZOOM AREA> key) are enabled.

**Target Line**

The target line function displays the targeted spectrum on the measurement screen without comparing it to the measured waveform.

This function can be used for displaying and adjusting the target spectrum serving as a reference for adjustments such as adjusting the optical axis of an optical device.

Target Line Display

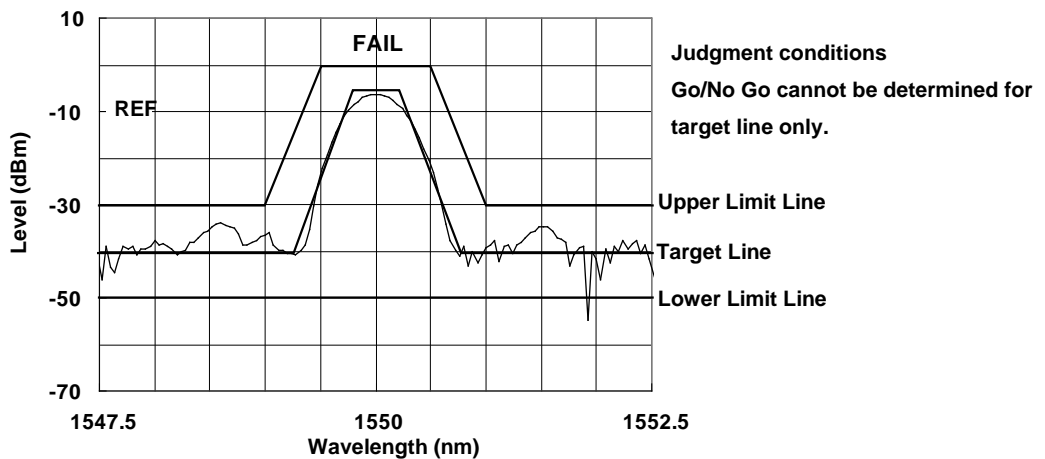

**Template Data**

- Template data consist of wavelength and level data. Up to 50,001 points of data may be defined.
- An upper limit, lower limit, and target line can be set.
- The on-screen template data display range and the Go/No Go test function execution range follow the display scale wavelength range.

**Relationship between Go/No Go Judgment and Wavelength Range**

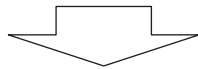
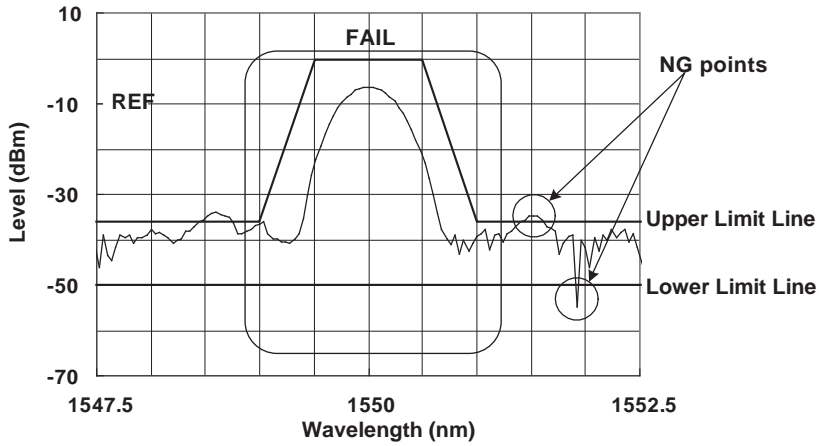

If the waveform is zoomed and the NG point is outside the displayed range, the judgment result is PASS.

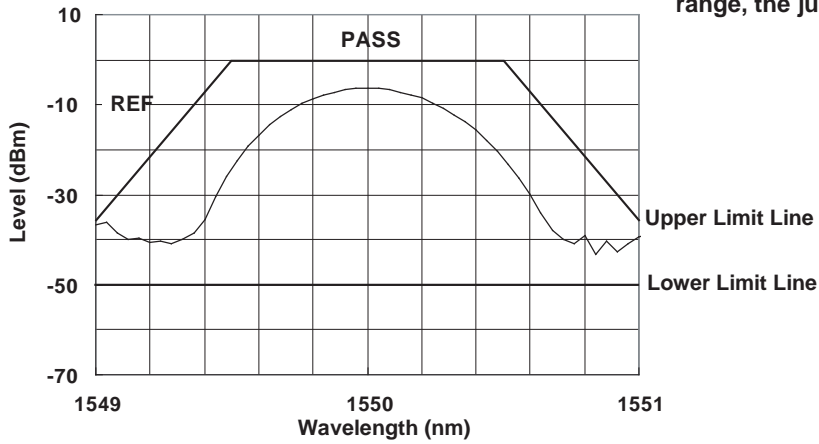

**Note**

When performing Go/No Go judgment, display the wavelength range on the screen. The Go/No Go testing process is not performed on wavelength ranges that are not displayed.

## Template Data Types

### ABSOLUTE Templates

ABSOLUTE template data specify both wavelengths and levels as absolute values. The waveform and template data change in conjunction with changes to the center wavelength or display sweep width on the display scale.

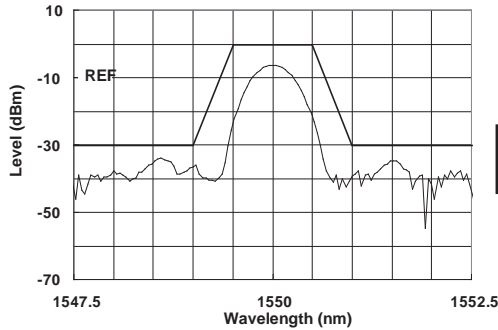

When ZOOM CENTER WL = 1550 nm

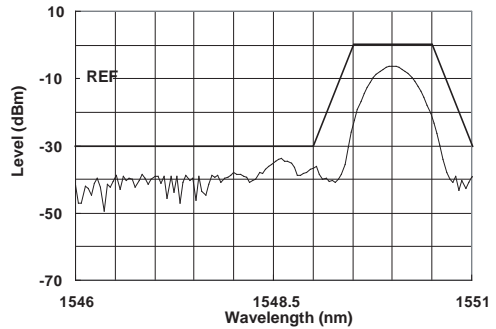

When ZOOM CENTER WL is changed to 1548.5 nm  
(template also moves in synch with the waveform)

### RELATIVE Templates

RELATIVE template data are specified as relative values with respect to the display scale. These template data are fixed to the scale position even if the center wavelength or display sweep width of the display scale is changed (not linked to the waveform).

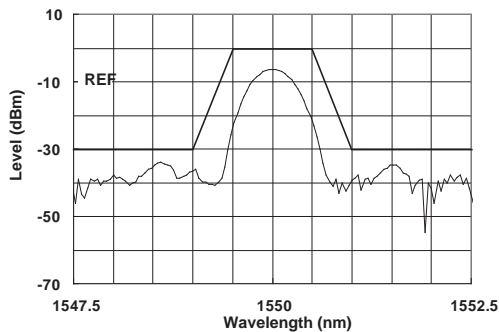

When ZOOM CENTER WL = 1550 nm

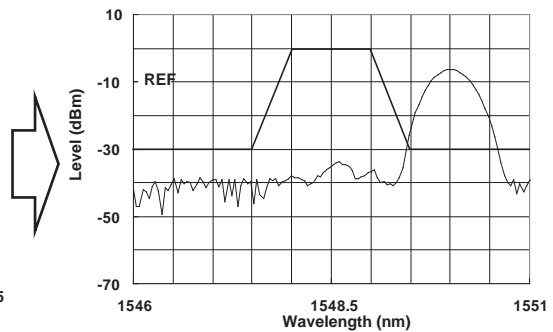

When ZOOM CENTER WL is changed to 1548.5 nm  
(template not moved)

### Extrapolating Template Data

In cases where the display scale is outside the defined range for template data, the template data outside the range can be extrapolated.

The following three types of extrapolation are available in these situations.

- Type A Extends the outermost data point of the template data to the outside.
- Type B Extends, to the outside, a line joining the outermost template data and the adjacent data point.
- None No extrapolation.

#### For Type A and Type B

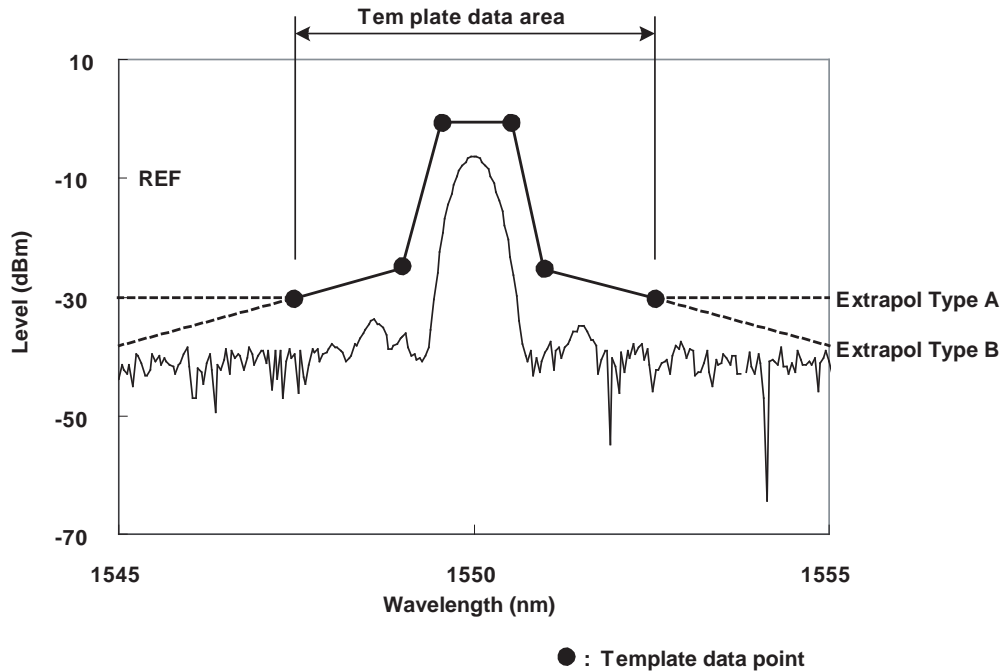

#### For Extrapolation Type of None

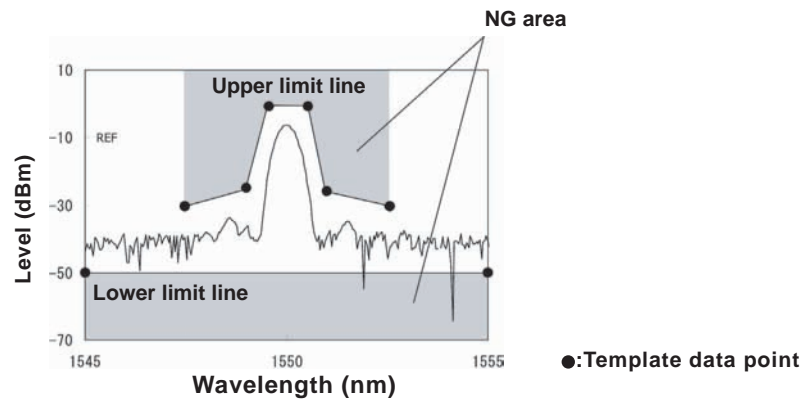

#### Note

- Data created through extrapolation is limited by the LOG LIMIT setting.
- For templates set to None, the Go/No Go judgment range from the template can be narrower than the waveform display screen. Pay attention to the judgment execution ranges for the upper limit and lower limit lines.

## Template Data Format

The file extension for template data file names is always .CSV.

The template data format is shown below. Here, all capital letters are used. As many as 50,001 template data points can be defined.

Save the template data created on an external PC to a USB storage device for loading in the instrument.

	A	B
1	AQ6370	
2	TEMPLATE	
3	TYPE	ABSOLUTE
4	EXTRAPOL	A
5	1540.000	-20.00
6	1550.000	-10.00
7	1560.000	-20.00

<- Header for the AQ6370

<- Header indicating template data

<- Header indicating the template type (ABSOLUTE or RELATIVE)

<- Extrapolation type (A or B or None)

<- Wavelength and level data (1550.123, -20.00)

Up to 50001 points of data sorted in order starting from the data of the smallest wavelength

.CSV file containing the above template data

```
AQ6370,
TEMPLATE,
TYPE,ABSOLUTE
EXTRAPOL,A
1540.000,-20.00
1550.000,-10.00
1560.000,-20.00
```

### Note

- Only English capital letters and numbers are supported for all template data.
- Like normal templates, template data can contain up to 50001 points.
- The .CSV extension must be used when saving.
- If the format is not unified, the instrument will not be able to load the template data.

## 7.13 Specifying an Analysis Range

### Analysis between Line Markers

#### Power Measurement between Line Markers

You can determine the totalized power for the area enclosed by wavelength line marker 1 and wavelength line marker 2.

1. Set wavelength line marker 1 and wavelength line marker 2 at either end of the range where you want to measure the totalized power.
2. Press the **MARKER** switch. The soft key menu for marker settings appears.
3. Press the **MORE 1/3**, **MORE 2/3** soft keys in succession.
4. Press the **SEARCH/ANA L1-L2** soft key, and select ON. When this key is set to ON, **[SRC 1-2]** is displayed at the very bottom of the screen.
5. Press **ANALYSIS**. The soft key menu for analyzing measured waveforms appears.
6. Press the **ANALYSIS 1** soft key. The analysis function selection menu is displayed.
7. Press the **POWER** soft key. Analysis is performed between line markers, and the results are displayed in the data area.
8. To cancel, press the **SEARCH/ANA L1-L2** soft key, and select OFF. Analysis is performed over the entire screen.

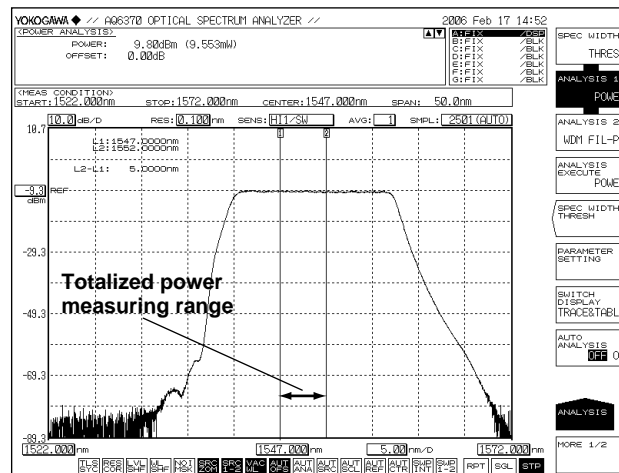

#### Note

- If both L1 and L2 are set, measurement is executed between line markers 1 and 2.
- If just L1 is set, the measurement occurs over the span from line marker 1 to the right edge of the screen.
- If just L2 is set, the measurement occurs over the span from the left edge of the screen to line marker 2.
- If neither L1 nor L2 is set, measurement is performed from the set start wavelength to the stop wavelength.

## Analysis in the Zoom Area

### Power Measurement in the Zoom Area

Optical power can be measured by integrating the measured waveform level measurements in the zoom area.

1. Zoom in on the measured waveform. Set the range you want to measure to the display scale. For the procedure on zooming in on the waveform, see section 6.1, "Zooming In/Out on a Waveform."
2. Press the **MARKER** switch. The soft key menu regarding the markers appears.
3. Press the **MORE 1/3**, **MORE 2/3** soft keys in succession.
4. Press the **SEARCH/ANA ZOOM AREA** soft key, and select ON.

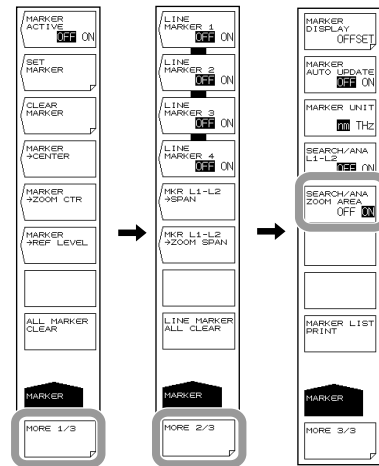

5. Press **ANALYSIS**. The soft key menu for analyzing measured waveforms appears.
6. Press the **ANALYSIS 1** soft key. The analysis function selection menu is displayed.
7. Press the **POWER** soft key. Analysis is performed between display scales, and the results are displayed in the data area.

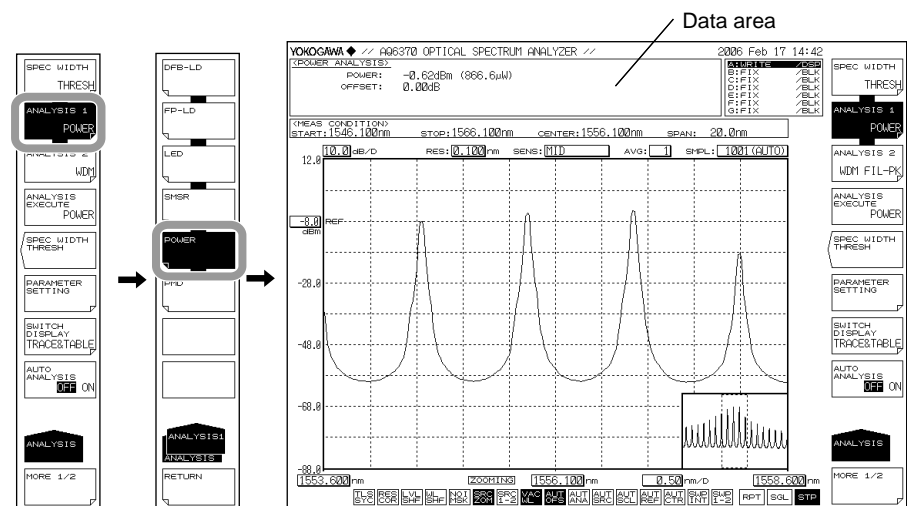

### Note

- When the zoom area search function is enabled, **SRC ZOM** is displayed in inverse video.
- If the SEARCH/ANA ZOOM AREA key is OFF, analysis is performed over the entire range of the measurement scale.
- For details on the POWER analysis function, see appendix 3, "Details of Analysis Functions."

### 7.13 Specifying an Analysis Range

#### Explanation

When the line marker search function and zoom area search functions are enabled at the same time, the intersection of the two ranges is the range for analysis.

The following shows the POWER measurement analysis range when both the **SEARCH/ANA L1-L2** and **SEARCH/ANA ZOOM AREA** soft keys are ON.

As both of these soft keys are ON, **SEARCH** and **ZOOM** at the bottom of the screen are displayed in inverse video.

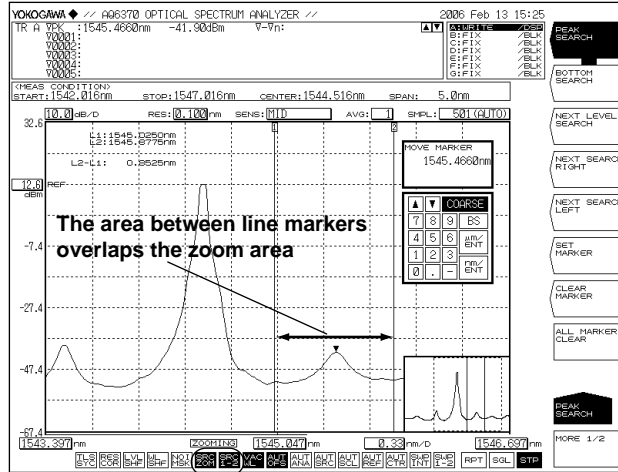

## 7.14 Correcting Displayed Values

### Procedure

#### Setting the Wavelength Shift Amount

1. Press **SYSTEM**.
2. Press the **WL SHIFT** soft key. The wavelength shift setting screen is displayed.
3. Enter a wavelength shift amount using the rotary knob, arrow keys, or numeric key pad.
4. Press **ENTER**.

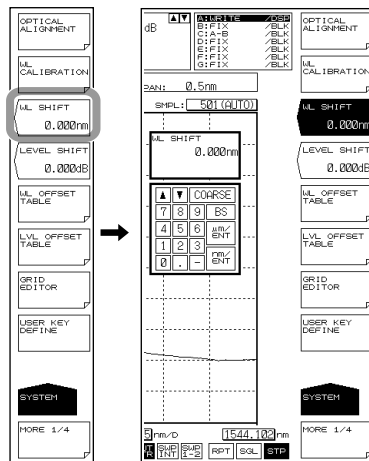

#### Setting the Level Shift Amount

1. Press **SYSTEM**.
2. Press the **LEVEL SHIFT** soft key. The level shift setting screen is displayed.
3. Enter a level shift amount using the rotary knob, arrow keys, or numeric key pad.
4. Press **ENTER**.

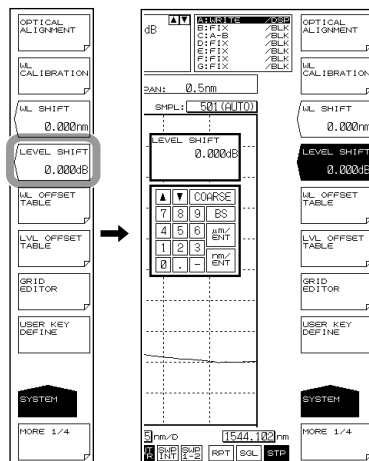

#### Note

After entering the wavelength or level shift amount, the setting is applied to the displayed values upon the next measurement.

### Determining the Level Shift Amount

Even if NA of the optical fiber used is unknown, the level shift amount enabling correct level measurements can be determined.

1. Set up a light source such as a DFB-LD with a spectrum width that is narrower than the instrument's resolution (with a wavelength of 1310 nm or 1550 nm).
2. Connect the light source and the instrument using an optical fiber cord and set the instrument's resolution to 1.000 nm.
3. Execute measurement and determine the peak level.
4. Disconnect the optical fiber cord from the instrument and connect it to a light power meter to measure the light power.
5. Calculate the difference between the peak level value obtained from the instrument and the power value obtained from the light power meter, and set this amount as the instrument's level shift.

### Explanation

#### Input Optical Fiber Numerical Aperture (NA) and Level Measurement Values

The level measurement error of the instrument changes as shown in the figure below, according to the numerical aperture (NA) of the optical fiber connected to the input connector. The instrument's absolute level is calibrated using a 9.5/125  $\mu\text{m}$  single-mode optical fiber (SSMA type in JIS C6835, with PC polishing, 9.5  $\mu\text{m}$  mode field diameter, and 0.104 to 0.107 NA). Even if a single-mode optical fiber is used, the level accuracy will be outside the specifications if the NA is not in the range shown above.

Input optical fiber numerical aperture and level error (typical characteristics)

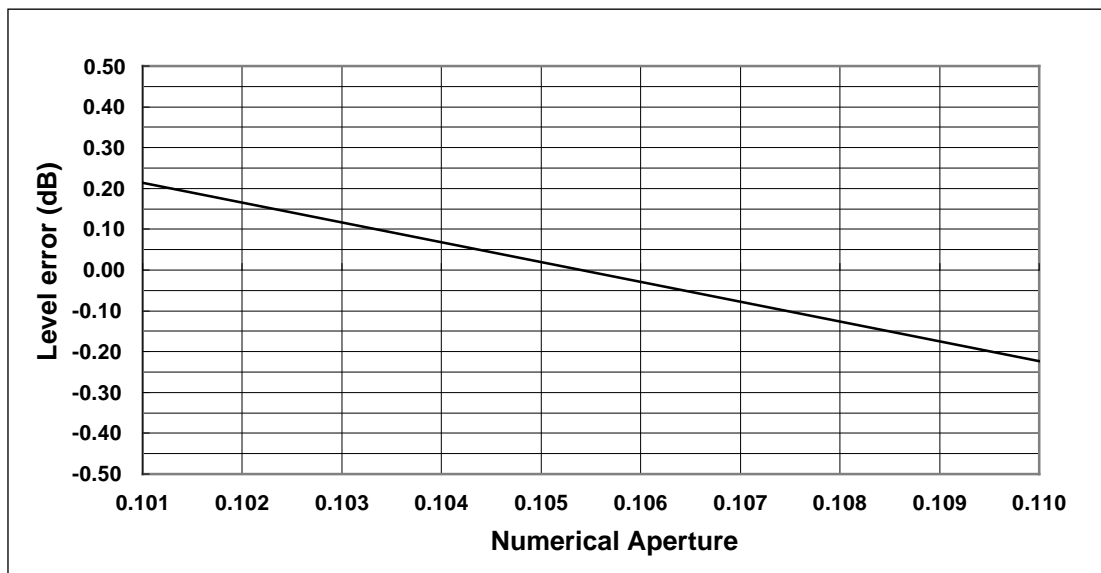

### Absolute Level Accuracy

The instrument's absolute level is calibrated with a 9.5  $\mu\text{m}$  single-mode optical fiber. In terms of actual capability, even single-mode optical fibers that do not have a core diameter of 9.5  $\mu\text{m}$  provide nearly the same level of accuracy.

Multimode (GI) fiber provides a relatively accurate spectrum if the light source is low-coherent light such as white light, natural light, or an LED. If the light source has high coherency as in the case of a laser beam, interference will occur inside the optical fiber, and the intensity distribution of light radiating from the fiber tip will vary according to the fiber form. As a result, the spectrum (measurement level) may fluctuate if the fiber is moved.

When an optical fiber with a large core diameter or large NA value is used, a low fraction of the light emitted from the optical fiber is received. Therefore, the measurement level is lower than the true value, but the optical spectrum is accurate in relative terms.

### WL SHIFT \*\*. \*\*nm

This key is used to set the wavelength shift.

When the wavelength shift is changed, the set value is added to the display value on the wavelength axis. This key is used for purposes such as correcting differences in wavelength display values among different measurement instruments.

The setting range is -5.000 to 5.000 nm. Settings can be adjusted in steps of 0.001 nm.

The value changes in steps of 0.1 nm if you press the COARSE key.

When setting the wavelength shift amount,  is displayed at the bottom of the screen in inverse video.

### LEVEL SHIFT\*\*\*.\*\*\*dB

This key is used to set the level shift.

When the level shift is changed, the set value is added to the display value on the level axis.

This key is used for purposes such as correcting level errors due to differences in the NA values of 9.5/125  $\mu\text{m}$  SM optical fibers connected to the instrument, and correcting loss on externally connected isolators, filters and the like.

The setting range is -60.00 to 60.00 dB. Settings can be adjusted in steps of 0.01 dB.

The value changes in steps of 0.1 dB if you press the COARSE key.

When setting the wavelength shift amount,  is displayed at the bottom of the screen in inverse video.

## 8.1 USB Storage Media

### Supported USB Storage Media

The instrument supports USB 1.0 or USB 2.0 compliant USB memory devices or hard disks. For details, contact your nearest Yokogawa representative.

### Removing USB Storage Media

Always follow the procedure below when removing USB storage media.

1. Press **FILE**. The file menu is displayed.  
Check whether the **REMOVE USB STORAGE** soft key is enabled or disabled (dimmed). If the REMOVE USB STORAGE soft key is disabled (dimmed), the USB storage media can be safely removed.
2. If the REMOVE USB STORAGE soft key is enabled, press the **REMOVE USB STORAGE** soft key. If the REMOVE USB STORAGE soft key is disabled (dimmed), the USB storage media can be safely removed.



For other precautions, please read the user's manual of your USB memory device.

## 8.2 Temporarily Saving and Redisplaying Traces to and from Internal Memory

### Procedure

You can save waveforms being displayed by the instrument to the instrument's internal memory, and redisplay data that has been saved to the internal memory.

#### Temporarily Saving Trace Data to Internal Memory

1. Press **MEMORY**. The soft key menu for the internal memory appears.
2. Press the **SAVE** soft key. The internal memory list and trace list are displayed.
3. Select a destination memory number using the **rotary knob**, **arrow keys**, or **numeric key pad**.
4. Press the soft key corresponding to the trace to be saved. The trace data is saved to the selected memory number.

YOKOGAWA // AQ6370 OPTICAL SPECTRUM ANALYZER // 2006 Feb 27 11:44

WRITE : TRACE TO MEMORY NO. 01

TR	CENTER	SPAN	REF LVL	LVL SCL	RESLN	AVG	SAMPL	SENS	ATTR
A	1150.000nm	1100.0nm	-10.0dBm	10.0dB	1.000nm	1	5501	NORM-AUT	MEAS
B	1150.000nm	1100.0nm	-10.0dBm	10.0dB	1.000nm	1	5501	NORM-AUT	MEAS
C	1150.000nm	1100.0nm	-10.0dBm	10.0dB	1.000nm	1	5501	NORM-AUT	MEAS
D	1150.000nm	1100.0nm	-10.0dBm	10.0dB	1.000nm	1	5501	NORM-AUT	MEAS
E	1150.000nm	1100.0nm	-10.0dBm	10.0dB	1.000nm	1	5501	NORM-AUT	MEAS
F	1150.000nm	1100.0nm	-10.0dBm	10.0dB	1.000nm	1	5501	NORM-AUT	MEAS
G	1150.000nm	1100.0nm	-10.0dBm	10.0dB	1.000nm	1	5501	NORM-AUT	MEAS

NO	LABEL	ATTR
00	/// AQ6370 OPTICAL SPECTRUM ANALYZER //	MEAS
01	/// AQ6370 OPTICAL SPECTRUM ANALYZER //	MEAS
02		
03		
04		
05		
06		
07		
08		
09		
10		
11		
12		
13		
14		
15		
16		
17		
18		
19		

Change display contents

### Redisplaying Trace Data

1. Press **MEMORY**. The soft key menu for the internal memory appears.
2. Press the **RECALL** soft key. The internal memory list and trace list are displayed.
3. Select a source memory number using the **rotary knob**, **arrow keys**, or **numeric key pad**.
4. Press the soft key corresponding to the trace number to assign to the data of the selected memory number.
5. Returning to the waveform display screen, data of the selected memory number is displayed in the specified trace number.

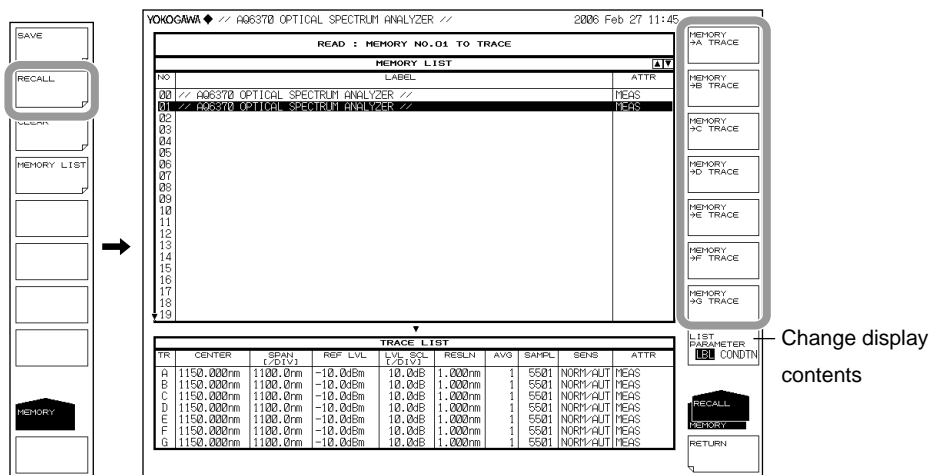

### Clearing Memory Data

1. Press **MEMORY**. The soft key menu for the internal memory appears.
2. Press the **CLEAR** soft key. The internal memory list and trace list are displayed.
3. Select the memory number of the data to be cleared using the **rotary knob**, **arrow keys**, or the **UP/DOWN arrow** soft keys.
4. Press the **EXECUTE** soft key. The data of the selected memory number is cleared.

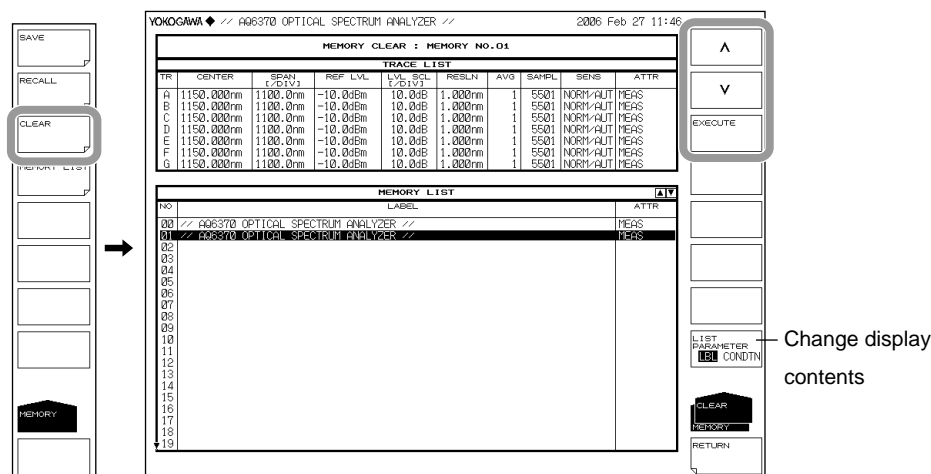

## 8.2 Temporarily Saving and Redisplaying Traces to and from Internal Memory

### Displaying and Changing the Memory List

1. Press **MEMORY**. The soft key menu for the internal memory appears.
2. Press the **MEMORY LIST** soft key. The internal memory list and trace list are displayed.
3. Press the **LIST PARAMETER** soft key, then select either **LBL** (label) or **CONDTN** (data measurement condition).

The displayed items of the memory list change to labels or measurement conditions. You can also change the display contents of the memory list by using the **SAVE**, **RECALL**, and **CLEAR** menus.

**LBL (Label)**

YOKOGAWA ♦ A96370 OPTICAL SPECTRUM ANALYZER // 2006 Feb 27 13:12

**MEMORY LIST**

TRACE LIST										
TR	CENTER	SPAN	REF LVL	LVL	SCL	RESLN	AVG	SAMPL	SENS	ATTR
A	1150.000nm	1100.0nm	-10.0dBm	10.0dB	1.000nm	1	5501	NORM-AUT	MEAS	
B	1150.000nm	1100.0nm	-10.0dBm	10.0dB	1.000nm	1	5501	NORM-AUT	MEAS	
C	1150.000nm	1100.0nm	-10.0dBm	10.0dB	1.000nm	1	5501	NORM-AUT	MEAS	
D	1150.000nm	1100.0nm	-10.0dBm	10.0dB	1.000nm	1	5501	NORM-AUT	MEAS	
E	1150.000nm	1100.0nm	-10.0dBm	10.0dB	1.000nm	1	5501	NORM-AUT	MEAS	
F	1150.000nm	1100.0nm	-10.0dBm	10.0dB	1.000nm	1	5501	NORM-AUT	MEAS	
G	1150.000nm	1100.0nm	-10.0dBm	10.0dB	1.000nm	1	5501	NORM-AUT	MEAS	

**MEMORY LIST**

NO	LABEL	ATTR
00	A96370 OPTICAL SPECTRUM ANALYZER //	MEAS
01	A96370 OPTICAL SPECTRUM ANALYZER //	MEAS
02		
03		
04		
05		
06		
07		
08		
09		
10		
11		
12		
13		
14		
15		
16		
17		
18		
19		

SAVE  
RECALL  
CLEAR  
**MEMORY LIST**  
MEMORY  
LIST PARAMETER  
**LBL** CONDTN  
LIST  
MEMORY  
RETURN

**CONDIN (Measurement conditions)**

YOKOGAWA ♦ A96370 OPTICAL SPECTRUM ANALYZER // 2006 Feb 27 13:12

**MEMORY LIST**

TRACE LIST										
TR	CENTER	SPAN	REF LVL	LVL	SCL	RESLN	AVG	SAMPL	SENS	ATTR
A	1150.000nm	1100.0nm	-10.0dBm	10.0dB	1.000nm	1	5501	NORM-AUT	MEAS	
B	1150.000nm	1100.0nm	-10.0dBm	10.0dB	1.000nm	1	5501	NORM-AUT	MEAS	
C	1150.000nm	1100.0nm	-10.0dBm	10.0dB	1.000nm	1	5501	NORM-AUT	MEAS	
D	1150.000nm	1100.0nm	-10.0dBm	10.0dB	1.000nm	1	5501	NORM-AUT	MEAS	
E	1150.000nm	1100.0nm	-10.0dBm	10.0dB	1.000nm	1	5501	NORM-AUT	MEAS	
F	1150.000nm	1100.0nm	-10.0dBm	10.0dB	1.000nm	1	5501	NORM-AUT	MEAS	
G	1150.000nm	1100.0nm	-10.0dBm	10.0dB	1.000nm	1	5501	NORM-AUT	MEAS	

**MEMORY LIST**

NO	CENTER	SPAN	REF LVL	LVL	SCL	RESLN	AVG	SAMPL	SENS	ATTR
00	1150.000nm	1100.0nm	-10.0dBm	10.0dB	1.000nm	1	5501	NORM-AUT	MEAS	
01	1150.000nm	1100.0nm	-10.0dBm	10.0dB	1.000nm	1	5501	NORM-AUT	MEAS	
02										
03										
04										
05										
06										
07										
08										
09										
10										
11										
12										
13										
14										
15										
16										
17										
18										
19										

LIST PARAMETER  
**CONDTN**  
LIST  
MEMORY  
RETURN

### Explanation

Up to 64 data can be saved.

It is often useful to temporarily save waveform data for redisplay at a later time. The following data can be saved.

Types of Data	Display in List (ATTR Field)
Measured waveforms	MEAS
Normalized displayed waveforms	NORM A, NORM B, NORM C
Maximum value detection display waveforms	MAX_H
Minimum value detection display waveforms	MIN_H
Curve-fit waveforms	CRV FIT A, CRV FIT B, CRV FIT C
Peak curve fit waveforms	PKCVFIT A, PKCVFIT B, PKCVFIT C
LOG calculation display waveforms	A-B, B-A, A+B, C-D, D-C, C+D, D-E, E-D, D+E, C-F, F-C, C+F, E+F, F-E, E+F, F-E, E+F
Linear calculation display waveforms	A+B LIN, A-B LIN, B-A LIN, 1-k(A/B), 1-k(B/A), C+D LIN, C-D LIN, D-C LIN, D+E LIN, D-E LIN, E-D LIN, C+F LIN, C-F LIN, F-C LIN, E+F LIN, E-F LIN, F-ELIN

## 8.3 Saving/Loading Displayed Data

### Procedure

Waveforms displayed by the instrument and waveforms temporarily saved to internal memory can be saved to a USB storage medium or the internal memory, and loaded from the USB storage medium.

### CAUTION

Do not remove the USB storage medium or turn the power OFF while the USB storage medium access indicator is blinking. This can damage the data on the medium or the device itself. Also, always place a USB storage medium in the removable state (following the procedure in section 8.1) before removing it.

### Saving Trace Data

#### Setting the Type of the File to Be Saved to TRACE

1. Press **FILE**. The soft key menu for saving and loading data appears.
2. Press the **ITEM SELECT** soft key. The menu for selecting the type of files to be saved is displayed.
3. Press the **TRACE** soft key. TRACE is selected, and the screen returns to the previous stage.
4. Press the **WRITE** soft key. The TRACE LIST is displayed on screen.

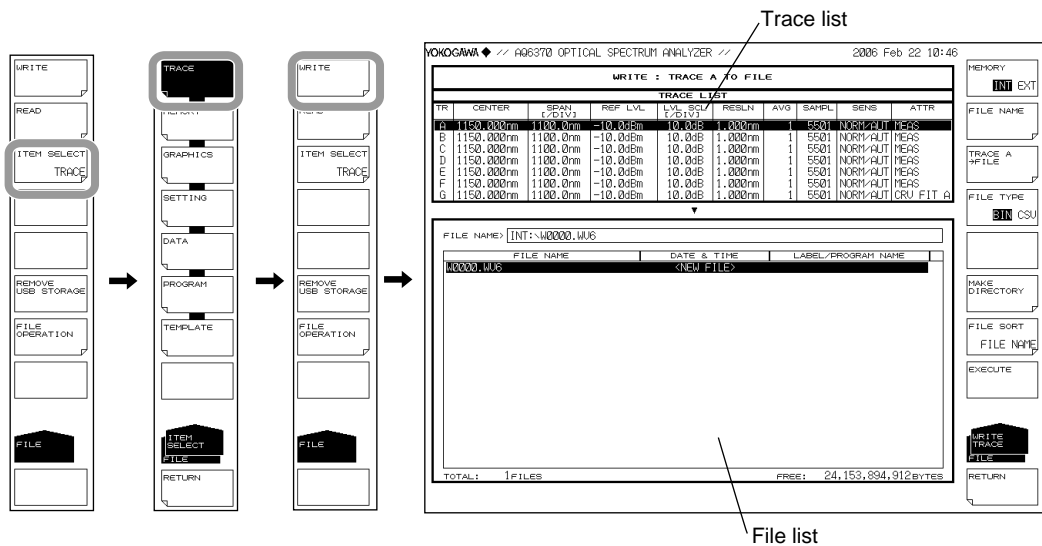

### Selecting the Save Destination and Data Format

5. Press the **MEMORY** soft key and specify a save destination of INT (internal memory) or EXT (USB storage medium).
6. Press the **FILE TYPE** soft key and specify a data format of BIN (binary) or CSV (ASCII format).



### Selecting a Trace to Save

7. Press the **TRACE @->FILE** soft key (where @ is the currently selected trace number). The trace selection menu is displayed.
8. Press the soft key corresponding to the trace to be saved.

Selected trace

WRITE : TRACE B TO FILE									
TRACE LIST									
TR	CENTER	SPAN (GHz)	REF LVL	LV (dB)	RESLN	AVG	SAMPL	SENS	ATTR
A	1150.000nm	1100.0nm	-10.0dBm	10.0dB	1.000nm	1	5501	NORM/AUT	PEAKS
B	1150.000nm	1100.0nm	-10.0dBm	10.0dB	1.000nm	1	5501	NORM/AUT	PEAKS
C	1150.000nm	1100.0nm	-10.0dBm	10.0dB	1.000nm	1	5501	NORM/AUT	PEAKS
D	1150.000nm	1100.0nm	-10.0dBm	10.0dB	1.000nm	1	5501	NORM/AUT	PEAKS
E	1150.000nm	1100.0nm	-10.0dBm	10.0dB	1.000nm	1	5501	NORM/AUT	PEAKS
F	1150.000nm	1100.0nm	-10.0dBm	10.0dB	1.000nm	1	5501	NORM/AUT	PEAKS
G	1150.000nm	1100.0nm	-10.0dBm	10.0dB	1.000nm	1	5501	NORM/AUT	CRU FIT A

### Entering a File Name (When Saving to an Arbitrary File Name)

If a file name is not entered, it is automatically assigned in the form WXXXX.CSV or WXXXX.WV6 (where XXXX is a serial number).

For creating a directory and sorting the file list, see the next page.

9. **Using the rotary knob**, move the cursor to the line in the file list displaying NEW FILE.
10. **Press the FILE NAME** soft key. The text entry window and corresponding soft key menu are displayed.
- 11 Follow the instructions in section 4.3 to enter a file name.
12. **Press the DONE** soft key. The file name is confirmed, and the screen returns to the previous stage.

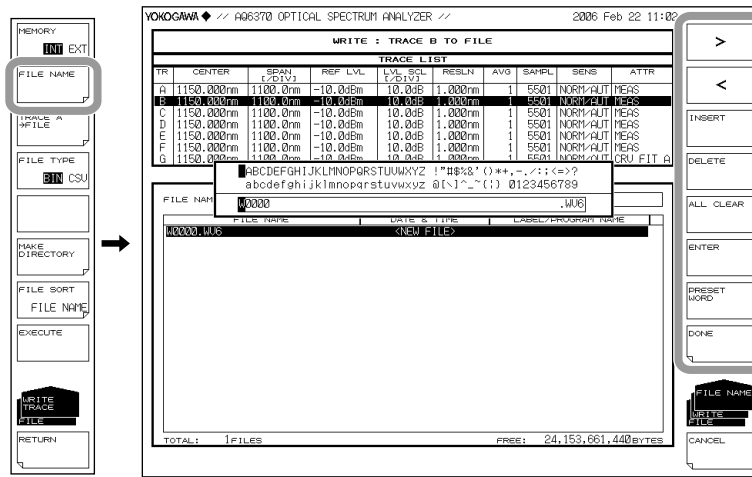

### Executing the Save

13. To overwrite an existing file, move the cursor to the file name to be overwritten.

14. **Press the EXECUTE** soft key. The save executes.

When the **RETURN** soft key is pressed, the data is saved. The screen returns to the previous stage.

15. When overwriting during a save, a confirmation message appears. Press the YES soft key.

To cancel the save press NO soft key.

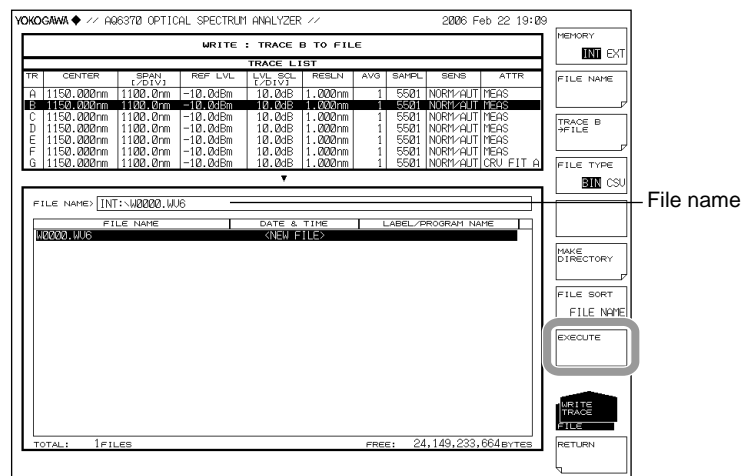

### Creating a Directory and Sorting Files

Perform the following procedure if needed.

16. Press the **MAKE DIRECTORY** soft key. The menu for creating directories is displayed.
17. Press the **DIRECTORY NAME** soft key. The text entry window and corresponding soft key menu are displayed. Enter a directory name in the same manner as when entering a file name.
18. Press the **EXECUTE** soft key. The directory is created. Press the **CANCEL** soft key to cancel creation of the directory.
19. Press the **FILE SORT** soft key. The file sort menu is displayed.
20. Press the soft key corresponding to the item by which to sort. The files are sorted in ascending order by the selected item.

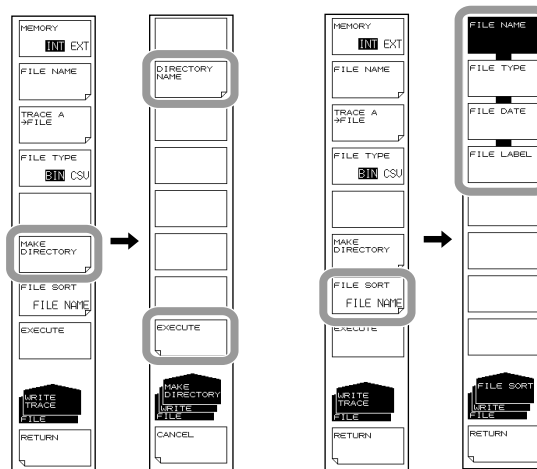

## Loading Trace Data

### Setting the Type of the File to Be Loaded to TRACE

1. Press **FILE**. The soft key menu for saving and loading data appears.
2. Press the **ITEM SELECT** soft key. The menu for selecting the type of files to be saved is displayed.
3. Press the **TRACE** soft key. TRACE is selected, and the screen returns to the previous stage.
4. Press the **READ** soft key. The file list is displayed on screen.

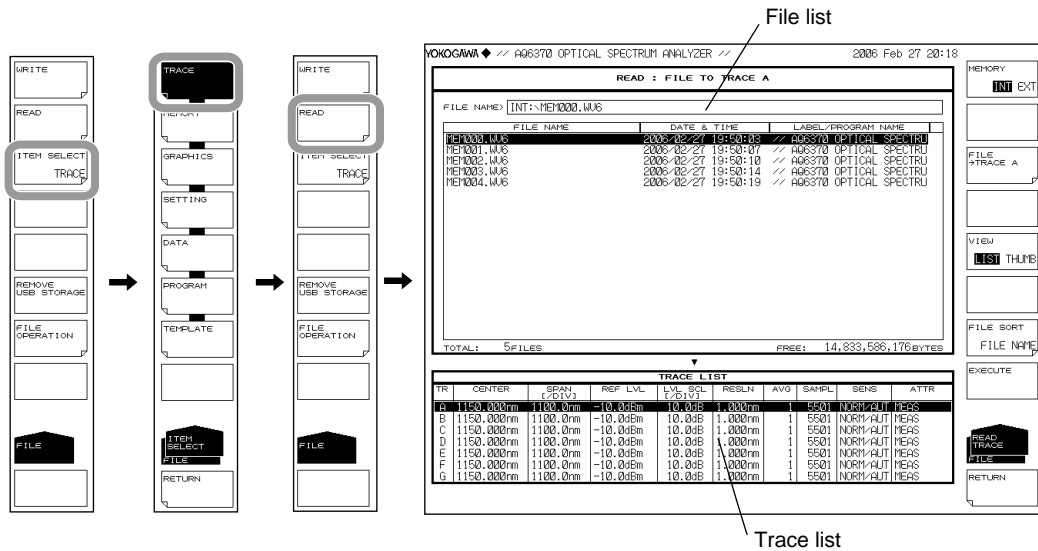

### Selecting the File to Be Loaded

5. Press the **MEMORY** soft key and specify INT (internal memory) or EXT (USB storage medium). A file list of the selected medium is displayed.
6. Select a file to load from the file list using the **rotary knob** or the **arrow keys**.  
If the **VIEW** soft key is pressed, the display toggles between list and thumbnail display. To sort the files, see page 8-9.

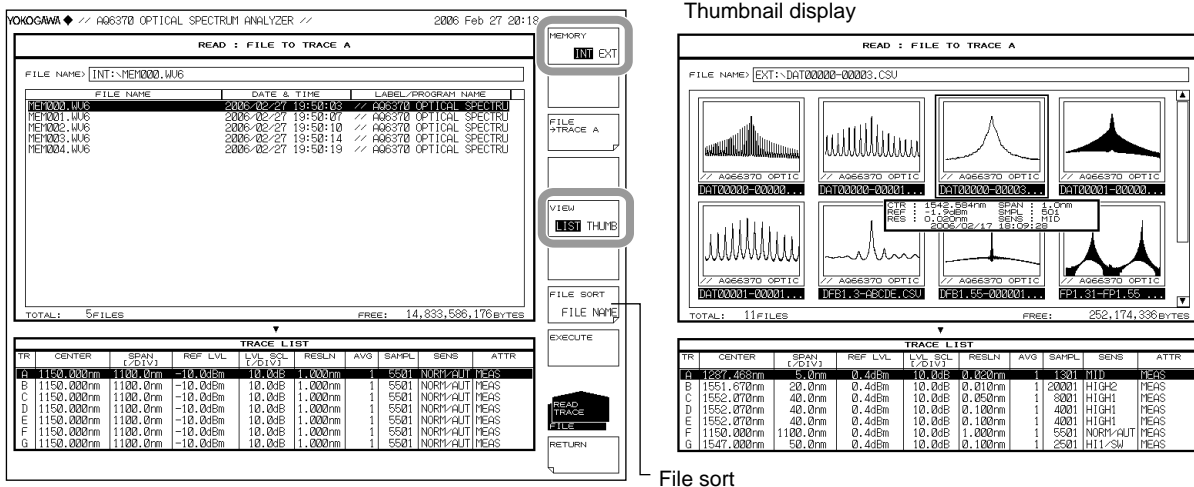

### Selecting a Trace from the Loaded Data

7. Press the **FILE->TRACE @** soft key (where @ is the currently selected trace number). The trace selection menu is displayed.
8. Press the soft key corresponding to the trace to be assigned.

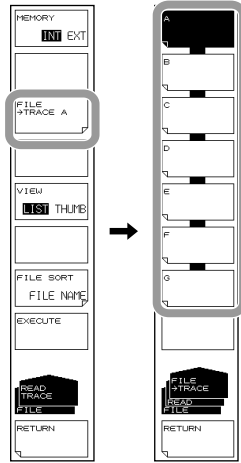

### Executing the Load

9. Press the **EXECUTE** soft key. The file is loaded and displayed as the specified trace number.

When the **RETURN** soft key is pressed, the file is not loaded. The screen returns to the previous stage.

YOKOGAWA // A66370 OPTICAL SPECTRUM ANALYZER // 2006 Feb 27 20:18

READ : FILE TO TRACE A

FILE NAME: [INT:\MEM1000.MUS]

FILE NAME	DATE & TIME	LABEL/PROGRAM NAME
MEM1000.MUS	2006-02-27 19:58:08	// A66370 OPTICAL SPECTRU
MEM1001.MUS	2006-02-27 19:58:07	// A66370 OPTICAL SPECTRU
MEM1002.MUS	2006-02-27 19:58:10	// A66370 OPTICAL SPECTRU
MEM1003.MUS	2006-02-27 19:58:14	// A66370 OPTICAL SPECTRU
MEM1004.MUS	2006-02-27 19:58:19	// A66370 OPTICAL SPECTRU

TOTAL: 5 FILES      FREE: 14,833,586,176 BYTES

TRACE LIST

TR	CENTER	SPAN	REF LVL	LVL SQL	RESLN	AVG	SAHPL	SENS	ATTR
A	1150.000nm	1100.0nm	-10.0dBm	10.0dB	1.000nm	1	5501	NORM-AUT	MEAS
B	1150.000nm	1100.0nm	-10.0dBm	10.0dB	1.000nm	1	5501	NORM-AUT	MEAS
C	1150.000nm	1100.0nm	-10.0dBm	10.0dB	1.000nm	1	5501	NORM-AUT	MEAS
D	1150.000nm	1100.0nm	-10.0dBm	10.0dB	1.000nm	1	5501	NORM-AUT	MEAS
E	1150.000nm	1100.0nm	-10.0dBm	10.0dB	1.000nm	1	5501	NORM-AUT	MEAS
F	1150.000nm	1100.0nm	-10.0dBm	10.0dB	1.000nm	1	5501	NORM-AUT	MEAS
G	1150.000nm	1100.0nm	-10.0dBm	10.0dB	1.000nm	1	5501	NORM-AUT	MEAS

Soft keys on the right: MEMORY [INT] EXT, FILE->TRACE A, VIEW [LIST] THUMB, FILE SORT FILE NAME, EXECUTE (highlighted), READ TRACE FILE, RETURN.

## Saving the Data Temporarily Saved to Internal Memory Setting the Type of the File to Be Saved to MEMORY

1. Press **FILE**.
2. Press the **ITEM SELECT** soft key. The soft key menu switches.
3. Press the **MEMORY** soft key. MEMORY is selected, and the screen returns to the previous stage.
4. Press the **WRITE** soft key. The memory list and file list are displayed.

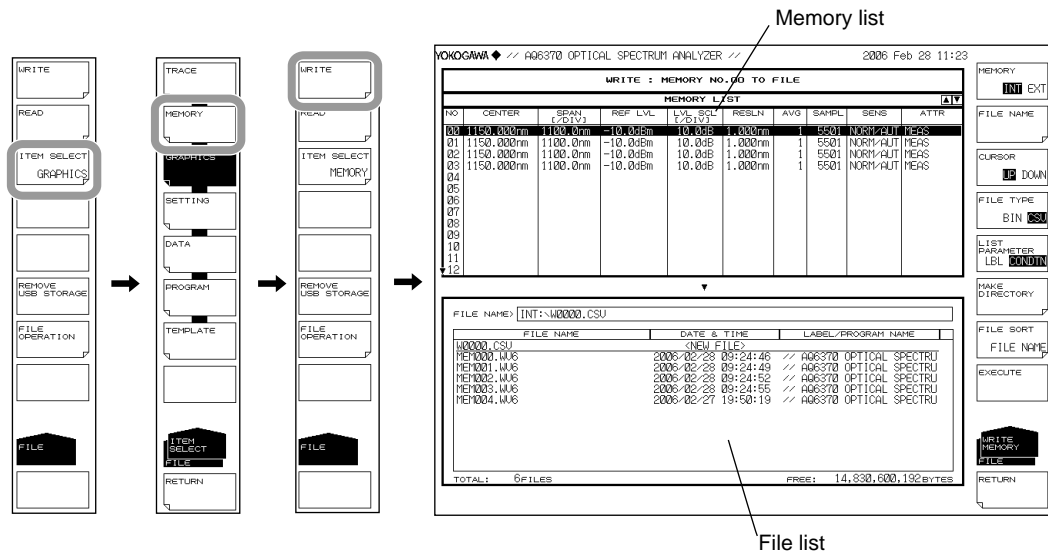

## Selecting the Save Destination and Data Format

5. Press the **MEMORY** soft key and specify a save destination of INT (internal memory) or EXT (USB storage medium).
6. Press the **FILE TYPE** soft key and specify a data format of BIN (binary) or CSV (ASCII format).



### Selecting a Memory Number to Save

7. Press the **CURSOR** soft key, then set the cursor selection to UP (on the memory list side).
8. Select the memory number of the data to save using the **rotary knob**, **arrow keys**, or **numeric key pad**.

Press the **LIST PARAMETER** soft key, allowing you to change the information displayed in the memory list to label names or measurement conditions. For more information, see section 8.2.

WRITE : MEMORY NO.00 TO FILE

NO	CENTER	SPAN	REF. LVL	LVL	RESLN	AVG	SAMP	SENS	ATTR
00	1150.000nm	1100.0nm	-10.0dBm	10.0dB	1.000nm	1	5501	NORM-AUT	MEAS
01	1150.000nm	1100.0nm	-10.0dBm	10.0dB	1.000nm	1	5501	NORM-AUT	MEAS
02	1150.000nm	1100.0nm	-10.0dBm	10.0dB	1.000nm	1	5501	NORM-AUT	MEAS
03	1150.000nm	1100.0nm	-10.0dBm	10.0dB	1.000nm	1	5501	NORM-AUT	MEAS
04									
05									
06									
07									
08									
09									
10									
11									
12									

FILE NAME: INT:\M0000.CSU

FILE NAME	DATE & TIME	LABEL/PROGRAM NAME
M0000.CSU	2006-02-28 09:24:46	// A06370 OPTICAL SPECTRU
MEM000.WV6	2006-02-28 09:24:49	// A06370 OPTICAL SPECTRU
MEM002.WV6	2006-02-28 09:24:52	// A06370 OPTICAL SPECTRU
MEM003.WV6	2006-02-28 09:24:55	// A06370 OPTICAL SPECTRU
MEM004.WV6	2006-02-27 19:58:19	// A06370 OPTICAL SPECTRU

TOTAL: 6 FILES FREE: 14,830,600,192 BYTES

### Entering the Name of the File to Be Saved

If a file name is not entered, it is automatically assigned in the form WXXXX.CSV or WXXXX.WV6 (where XXXX is a serial number).

For creating a directory and sorting the file list, see the page 8-9.

9. Press the **CURSOR** soft key, then set the cursor selection to DOWN (on the file list side). An underscore is displayed with the memory number selected in step 8.
10. Using the **rotary knob** or **arrow keys**, move the cursor to the line in the file list displaying NEW FILE.
11. Press the **FILE NAME** soft key. The text entry window and corresponding soft key menu are displayed.
- 12 Follow the instructions in section 4.3 to enter a file name.
13. Press the **DONE** soft key. The file name is confirmed, and the screen returns to the previous stage.

WRITE : MEMORY NO.00 TO FILE

NO	CENTER	SPAN	REF. LVL	LVL	RESLN	AVG	SAMP	SENS	ATTR
00	1150.000nm	1100.0nm	-10.0dBm	10.0dB	1.000nm	1	5501	NORM-AUT	MEAS
01	1150.000nm	1100.0nm	-10.0dBm	10.0dB	1.000nm	1	5501	NORM-AUT	MEAS
02	1150.000nm	1100.0nm	-10.0dBm	10.0dB	1.000nm	1	5501	NORM-AUT	MEAS
03	1150.000nm	1100.0nm	-10.0dBm	10.0dB	1.000nm	1	5501	NORM-AUT	MEAS
04									
05									
06									
07									
08									
09									
10									
11									
12									

FILE NAME: INT:\M0000.CSU

FILE NAME	DATE & TIME	LABEL/PROGRAM NAME
M0000.CSU	2006-02-28 09:24:46	// A06370 OPTICAL SPECTRU
MEM001.WV6	2006-02-28 09:24:49	// A06370 OPTICAL SPECTRU
MEM002.WV6	2006-02-28 09:24:52	// A06370 OPTICAL SPECTRU
MEM003.WV6	2006-02-28 09:24:55	// A06370 OPTICAL SPECTRU
MEM004.WV6	2006-02-27 19:58:19	// A06370 OPTICAL SPECTRU

TOTAL: 6 FILES FREE: 14,830,600,192 BYTES

Executing the Save

14. To overwrite an existing file, move the cursor to the file name to be overwritten.

15. Press the EXECUTE soft key. The save executes.

When the RETURN soft key is pressed, the data is saved. The screen returns to the previous stage.

16. When overwriting during a save, a confirmation message appears. Press the YES soft key.

To cancel the save press NO soft key.

YOKOGAWA // A96370 OPTICAL SPECTRUM ANALYZER // 2006 Feb 28 11:23

WRITE : MEMORY NO.00 TO FILE

MEMORY LIST

NO	CENTER	SPAN (GHz)	REF. LVL	LVL (dB)	SCL (dB)	RESLN	AVG	SAMPL	SENS	ATTR
00	1150.000nm	1100.0nm	-10.0dBm	10.0dB	1.000nm	1	5501	NORM-AUT	MEAS	
01	1150.000nm	1100.0nm	-10.0dBm	10.0dB	1.000nm	1	5501	NORM-AUT	MEAS	
02	1150.000nm	1100.0nm	-10.0dBm	10.0dB	1.000nm	1	5501	NORM-AUT	MEAS	
03	1150.000nm	1100.0nm	-10.0dBm	10.0dB	1.000nm	1	5501	NORM-AUT	MEAS	
04										
05										
06										
07										
08										
09										
10										
11										
12										

FILE NAME: INT:MEM000.CSU

FILE NAME	DATE & TIME	LABEL/PROGRAM NAME
MEM000.CSU	2006-02-28 09:24:46	// A96370 OPTICAL SPECTRU
MEM001.WJG	2006-02-28 09:24:49	// A96370 OPTICAL SPECTRU
MEM002.WJG	2006-02-28 09:24:52	// A96370 OPTICAL SPECTRU
MEM003.WJG	2006-02-28 09:24:55	// A96370 OPTICAL SPECTRU
MEM004.WJG	2006-02-27 19:50:19	// A96370 OPTICAL SPECTRU

TOTAL: 6 FILES FREE: 14,830,600,192 BYTES

SOFT KEYS: MEMORY, INT, EXT, FILE NAME, CURSOR, UP, DOWN, FILE TYPE, BIN, LIST, PARAMETER, LBL, BOUND, MAKE DIRECTORY, FILE SORT, FILE NAME, EXECUTE, WRITE MEMORY, FILE, RETURN

## Loading from the Temporary Save Memory

### Setting the Type of the File to Be Loaded to MEMORY

1. Press **FILE**.
2. Press the **ITEM SELECT** soft key. The soft key menu switches.
3. Press the **MEMORY** soft key. MEMORY is selected, and the screen returns to the previous stage.
4. Press the **READ** soft key. The memory list and file list are displayed.

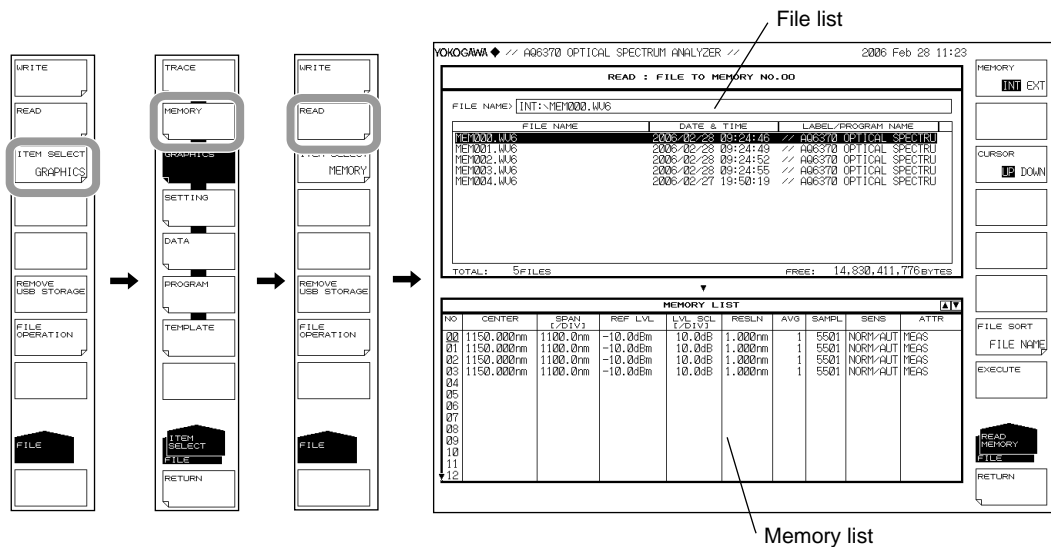

### Selecting the File to Be Loaded

5. Press the **MEMORY** soft key and specify INT (internal memory) or EXT (USB storage medium). A file list of the selected medium is displayed.
6. Press the **CURSOR** soft key, then set the cursor selection to UP (on the file list side).
7. Select a file to load from the file list using the **rotary knob** or the **arrow keys**.  
 You can also press the **FILE SORT** soft key to sort the files. For more information, see page 8-9.

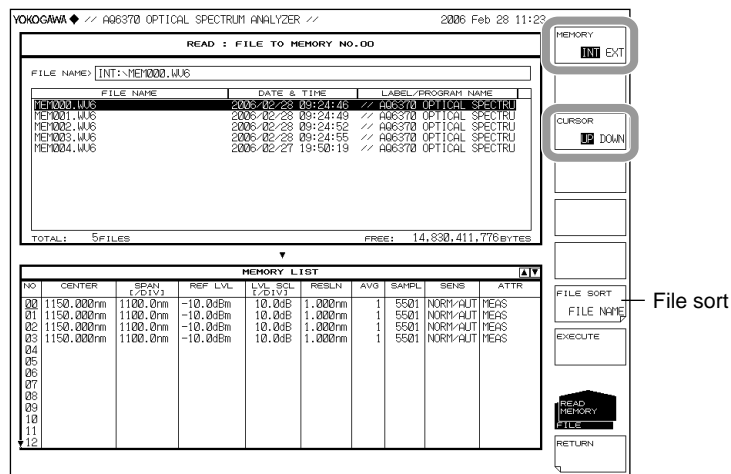

### 8.3 Saving/Loading Displayed Data

#### Selecting a Memory Number to Save

8. Press the **CURSOR** soft key, then set the cursor selection to DOWN (on the memory list side).
9. Select the memory number of the load destination using the **rotary knob**, **arrow keys**, or **numeric key pad**.

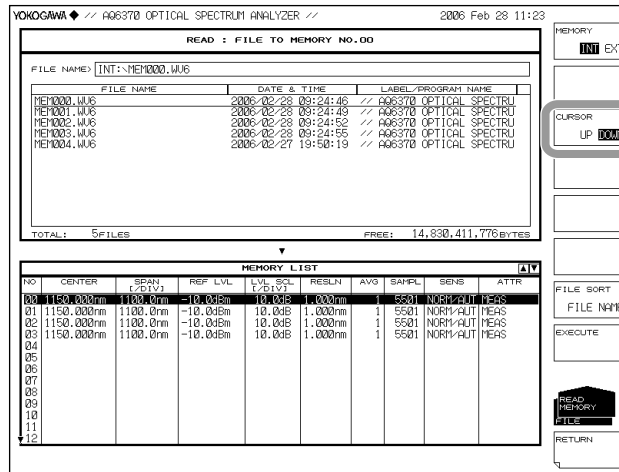

#### Executing the Load

10. Press the **EXECUTE** soft key. The file is loaded and registered into the specified memory number.

When the **RETURN** soft key is pressed, the file is not loaded. The screen returns to the previous stage.

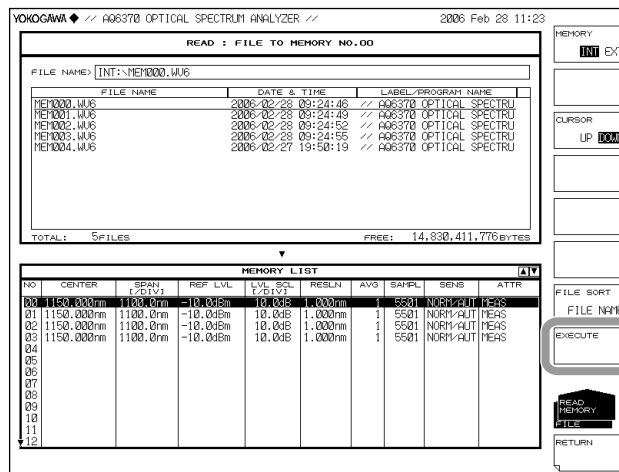

**Explanation**

You can save data from traces A–G to internal memory or a USB storage medium, or assign previously saved data to trace A–G and display it.

Also, you can save (MEMORY) data that was temporarily saved to internal memory or a USB storage medium, or register previously saved data to the temporary save memory.

**Extensions**

The extensions used when saving TRACE and MEMORY data are as follows.

BIN (binary format): .WV6

CSV (ASCII format): .CSV

**File Name**

You can have a file name automatically assigned, or specify an arbitrary name for the save. If you do not assign a file name, a file name is automatically assigned as follows.

File name: WXXXX.CSV (or .WV6)

XXXX is a serial number from 0000 to 9999

**Note**

Only use the characters allowed in file names by MS-DOS when changing a file name. The maximum file name length is 56 characters (including the extension). The following characters can be used in file names.

!#\$%&'()-

0123456789@

ABCDEFGHIJKLMNOPQRSTUVWXYZ^

abcdefghijklmnopqrstuvwxyz}~

**Data Format**

Data can be saved in the following two formats.

**BIN**

Saves the file in binary format.

With this selection, the waveform data cannot be directly checked using an external application. The file size is smaller than that obtained with ASCII format.

**CSV**

Saves the file in CSV (Comma Separated Value) ASCII format.

With this selection, the waveform data can be directly checked using an external application. The file size is larger than that obtained with binary format.

**File Size**

The file size differs depending on the data saved. Be sure to check whether sufficient space is available before saving.

**File Sort**

You can sort the file list in ascending order by file name, file type, file date, or label.

**CSV Data Format**

CSV data is saved in the following format.

```

70CSV2
// AQ6370 OPTICAL SPECTRUM ANALYZER //
25
"CTRWL",1553.200000
"SPAN", 20.000000
"START WL",1543.200000
"STOP WL",1563.200000
"WLFREQ", 0
"REFL",-10.0
"LSCL",10.0
"RESLN",0.200
"AVG", 1
"SMPLAUTO", 0
"SMPL", 1001
"SMPLINTVL",0.02
"HIGH 1"
"MEAS"
"LSUNT",0
"NMSKV","OFF"
"RESCOR",0
"RESPARM",10372
"FREQPARM",10372

[TRACE DATA]
1543.2000, -66.267
1543.2200, -66.295
:
:
:
1563.2000, -65.371
    
```

Header

Measurement condition parameters

Waveform data

**Header**

70CSV2	File header
// AQ6370 OPTICAL SPECTRUM ANALYZER //	Label (57 characters)
25	No. of measurement condition parameters

**Measurement Condition Parameters**

"CTRWL",1553.200000	Center wavelength
"SPAN", 20.000000	Span
"START WL",1543.200000	Measurement start wavelength
"STOP WL",1563.200000	Measurement stop wavelength
"WLFREQ", 0	Horizontal axis scale mode (0: wavelength mode, 1: frequency mode)
"REFL",-10.0	Reference level
"LSCL",10.0	Main level scale
"RESLN",0.200	Measurement resolution
"AVG", 1	Averaging times
"SMPLAUTO", 0	Sampling points setting mode (0: MANUAL, 1: AUTO, 2: SMPL INTVL)
"SMPL", 1001	The number of sampling points for measurements
"SMPLINTVL", 0.02	Measurement sampling interval

"HIGH 1"	Measurement sensitivity
"MEAS"	Measurement identifier
"LSUNT",0	Vertical axis scale mode (0: dBm, 1: dBm/nm)
"NMSKV","OFF"	Noise mask setting (NMSKV:VERTICAL, NMSKH:HORIZONTAL)
"RESCORE",0	Resolution correction setting (0: OFF, 1: ON)
"RESPARM",10372	Wavelength resolution RMS coefficient
"FREQPARM",10372	Frequency resolution RMS coefficient

The reference level and main level scale are saved to one of the following depending on the vertical scale.

#### Main level scale

Vertical Axis Scale	Save Format	Description
LOG	"REFL",***.*	Reference level
	"LSCL",***.*	Level scale
Linear	"REFL",***.*	Reference level
	"LSCL",***.*	Level scale
	"BASEL",****.*	Base level

#### Sub-level scale

Vertical Axis Scale	Save Format	Description
LOG	"REFL",***.*	Reference level
	"SSCLOG",***.*	Level scale
	"LOFST",***.*	Level offset
Linear	"REFL",***.*	Reference level
	"SSCLN",***.*	Level scale
	"SMIN",****.*	Base level
DB/km	"REFL",***.*	Reference level
	"SSKM",***.*	Level scale
	"OFSKM",***.*	Offset level
	"LENG",**.*	Optical fiber length
%	"REFL",***.*	Reference level
	"SSPS",***.*	Level scale
	"SMINP",***.*	Base scale

#### Measurement Sensitivity

The data below is saved as measurement sensitivity depending on the measurement sensitivity type.

Format	Measurement Sensitivity Type
"NORM-HOLD"	NORM/HOLD
"NORM-AUTO"	NORM/AUTO
"NORMAL"	NORMAL
"MID"	MID
"HIGH 1"	HIGH 1 (CHOP OFF)
"HIGH 2"	HIGH 2 (CHOP OFF)
"HIGH 3"	HIGH 3 (CHOP OFF)
"HI1_CHOP"	HIGH 1 (CHOP ON)
"HI2_CHOP"	HIGH 2 (CHOP ON)
"HI3_CHOP"	HIGH 3 (CHOP ON)
"MID_SW"	MID (SWITCH ON)
"HI1_SW"	HIGH1 (SWITCH ON)
"HI2D_SW"	HIGH2 (SWITCH ON)
"HI3D_SW"	HIGH3 (SWITCH ON)

#### Note

If PEAK HOLD is selected in pulse light measurement mode, a P- is added to the front of the data above. Similarly, if EXTERNAL TRIGGER is selected, an E- is added.

### 8.3 Saving/Loading Displayed Data

#### Measurement Identifier

The data below is saved as a waveform identifier depending on the waveform type.

Format	Waveform Type	Format	Waveform Type	Format	Waveform Type
"MEAS"	WRITE	"E-D"	E-D(LOG)	"C+FL"	C+F(LIN)
"MAXH"	MAX HOLD	"C+D"	C+D(LOG)	"C-FL"	C-F(LIN)
"MINH"	MIN HOLD	"D+E"	D+E(LOG)	"F-CL"	F-C(LIN)
"RAVG"	ROLL AVG	"C+DL"	C+D(LIN)	"E+FL"	E+F(LIN)
"A-B"	A-B(LOG)	"C-DL"	C-D(LIN)	"E-FL"	E-F(LIN)
"B-A"	B-A(LOG)	"D-CL"	D-C(LIN)	"F-EL"	F-E(LIN)
"A+B"	A+B(LOG)	"D+EL"	D+E(LIN)	"NORM A"	NORMALIZE A
"A-BL"	A-B(LIN)	"D-EL"	D-E(LIN)	"NORM B"	NORMALIZE
"B-AL"	B-A(LIN)	"E-DL"	E-D(LIN)	"NORM C"	NORMALIZE
"A+BL"	A+B(LIN)	"C-F"	C-F(LOG)	"CVFT A",**	CRV FIT A
"1-K(A/B)",*****	1-k(A/B)	"F-C"	F-C(LOG)	"CVFT B",**	CRV FIT B
"1-K(B/A)",*****	1-k(B/A)	"E-F"	E-F(LOG)	"CVFT C",**	CRV FIT C
"C-D"	C-D(LOG)	"F-E"	F-E(LOG)	"CVFTPK A",**	PK CRV FIT A
"D-C"	D-C(LOG)	"C+F"	C+F(LOG)	"CVFTPK B",**	PK CRV FIT B
"D-E"	D-E(LOG)	"E+F"	E+F(LOG)	"CVFTPK C",**	PK CRV FIT C

#### Waveform Data

Measures waveform data are stored as wavelength values and level values for the number of measurement sampling points.

A waveform measured in frequency mode is also stored as wavelength values. Level values are stored as log values if the vertical axis scale is LOG, and as linear values if the vertical axis scale is linear.

(For LOG Scale)

[TRACE DATA] Header indicating the start of the trace data  
 \*\*\*\*.\*\*\*, ±\*\*\*.\*\*\*(CR)(LF) Wavelength value and level value (LOG) of first point  
 \*\*\*\*.\*\*\*, ±\*\*\*.\*\*\*(CR)(LF) Wavelength value and level value (LOG) of second point  
 :  
 \*\*\*\*.\*\*\*, ±\*\*\*.\*\*\*(CR)(LF) Wavelength value and level value (LOG) of final point

(For LINEAR Scale)

[TRACE DATA] Header indicating the start of the trace data  
 \*\*\*\*.\*\*\*, \*\*\*E±\*\*\*(CR)(LF) Wavelength value and level value (LINEAR) of first point  
 \*\*\*\*.\*\*\*, \*\*\*E±\*\*\*(CR)(LF) Wavelength value and level value (LINEAR) of second point  
 :  
 \*\*\*\*.\*\*\*, \*\*\*E±\*\*\*(CR)(LF) Wavelength value and level value (LINEAR) of final point

## 8.4 Saving/Loading Setting Data

### Procedure

The measurement conditions set on the instrument and soft key set statuses are saved in binary format.

### CAUTION

Do not remove the USB storage medium or turn the power OFF while the USB storage medium access indicator is blinking. This can damage the data on the medium or the device itself. Also, always place a USB storage medium in the removable state (following the procedure in section 8.1) before removing it.

### Setting the Type of the File to Be Saved to SETTING

1. Press **FILE**.
2. Press the **ITEM SELECT** soft key. The soft key menu switches.
3. Press the **SETTING** soft key. SETTING is selected, and the screen returns to the previous stage.
4. Press the **WRITE** soft key. The file list is displayed.

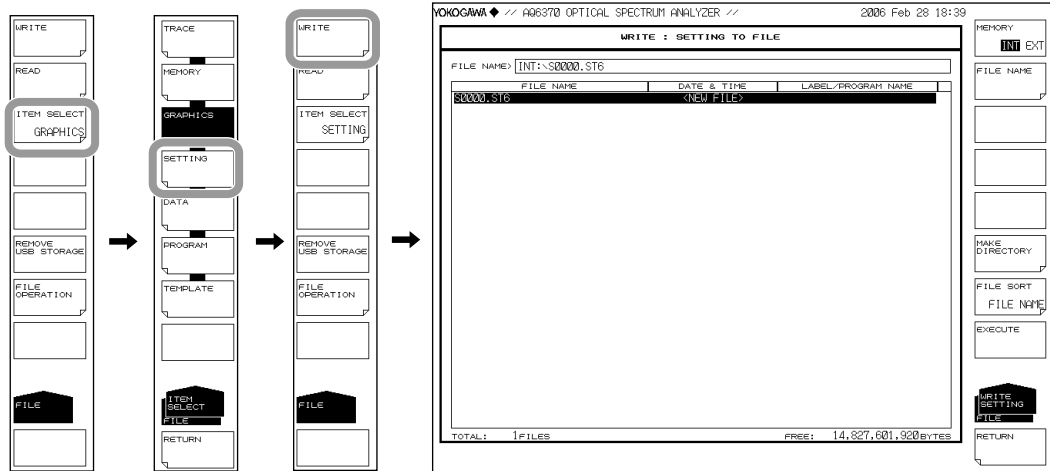

### Selecting the Save Destination Medium

5. Press the **MEMORY** soft key and specify INT (internal memory) or EXT (USB storage medium). A file list of the selected medium is displayed.



### Entering the Name of the File to Be Saved

If a file name is not entered, it is automatically assigned in the form SXXXX.ST6 (where XXXX is a serial number starting from 0000).

For creating a directory and sorting the file list, see the page 8-9.

6. Using the **rotary knob** or **arrow keys**, move the cursor to the line in the file list displaying NEW FILE.
7. Press the **FILE NAME** soft key. The text entry window and corresponding soft key menu are displayed.
8. Follow the instructions in section 4.3 to enter a file name.
9. Press the **DONE** soft key. The file name is confirmed, and the screen returns to the previous stage.

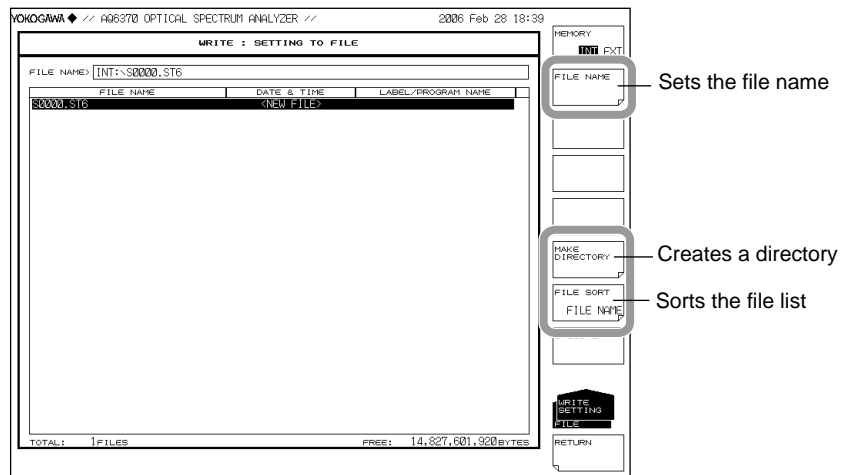

## Executing the Save

10. To overwrite an existing file, move the cursor to the file name to be overwritten.

11. Press the **EXECUTE** soft key. The save executes.

When the **RETURN** soft key is pressed, the data is saved. The screen returns to the previous stage.

12. When overwriting during a save, a confirmation message appears. Press the YES soft key.

To cancel the save press NO soft key.

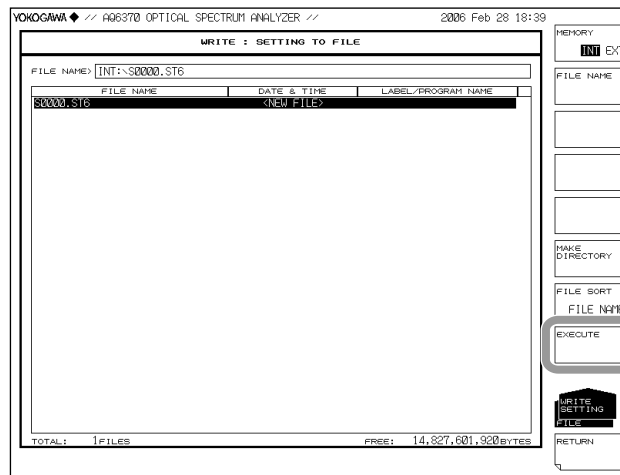

## Loading Settings

### Setting the Type of the File to Be Loaded to SETTING

1. Press **FILE**.

2. Press the **ITEM SELECT** soft key. The soft key menu switches.

3. Press the **SETTING** soft key. SETTING is selected, and the screen returns to the previous stage.

4. Press the **READ** soft key. The file list is displayed.

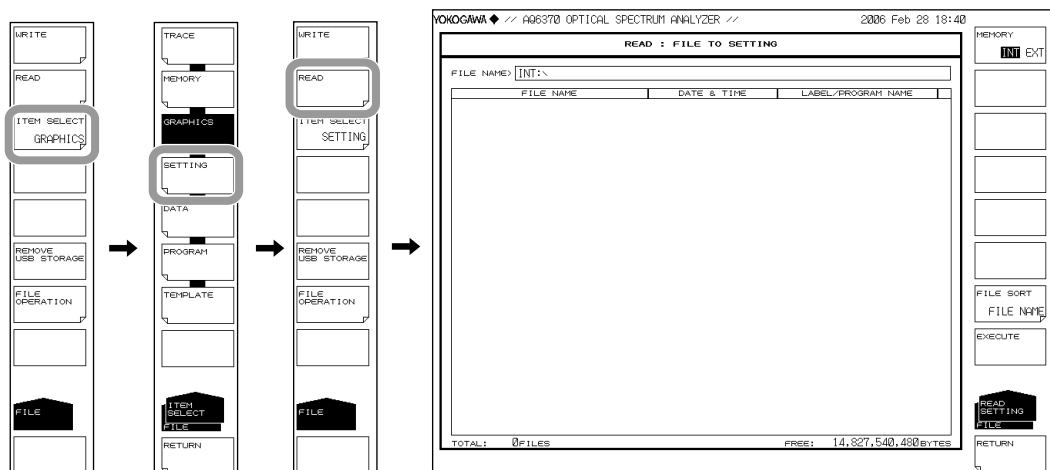

### Selecting the File to Be Loaded

5. Press the **MEMORY** soft key and specify INT (internal memory) or EXT (USB storage medium). A file list of the selected medium is displayed.
6. Select a file to load from the file list using the **rotary knob** or the **arrow keys**.  
You can also press the **FILE SORT** soft key to sort the files. For more information, see page 8-9.

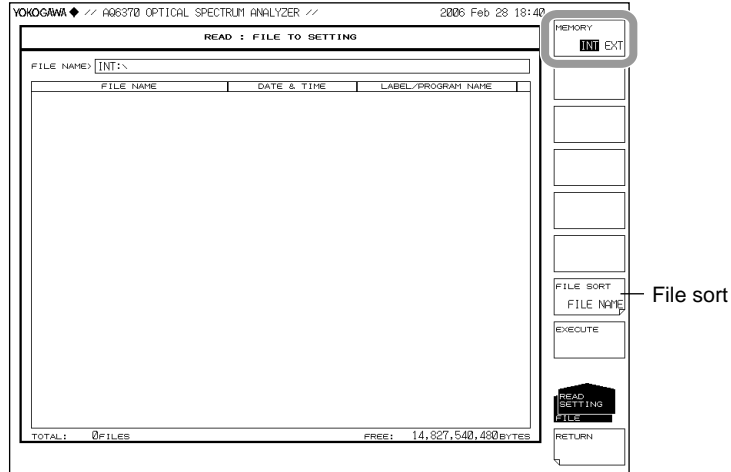

### Executing the Load

7. Press the **EXECUTE** soft key. The file is loaded and the settings on the instrument are changed.  
When the **RETURN** soft key is pressed, the file is not loaded. The screen returns to the previous stage.

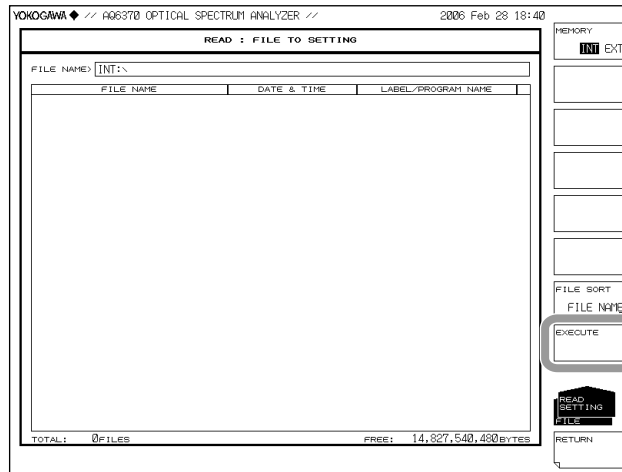

**Explanation**

You can save instrument setting data to internal memory or a USB storage medium, or load previously saved setting data and modify the settings.

**Extension**

The extension used when loading is .ST6.

**File Name**

You can have a file name automatically assigned, or specify an arbitrary name for the save. If you do not assign a file name, a file name is automatically assigned as follows.

File name: SXXXX.ST6

XXXX is a serial number from 0000 to 9999

**Note**

Only use the characters allowed in file names by MS-DOS when changing a file name. The maximum file name length is 56 characters (including the extension). The following characters can be used in file names.

!#\$%&'()-

0123456789@

ABCDEFGHIJKLMNOPQRSTUVWXYZ^

abcdefghijklmnopqrstuvwxyz}`

**File Size**

The file size is approximately 74 KB.

**File Sort**

You can sort the file list in ascending order by file name, file type, file date, or label.

## 8.5 Saving/Loading Analysis Results Data

### Procedure

You can save analysis results including the time and waveform data of the original save in ASCII or binary format.

### CAUTION

Do not remove the USB storage medium or turn the power OFF while the USB storage medium access indicator is blinking. This can damage the data on the medium or the device itself. Also, always place a USB storage medium in the removable state (following the procedure in section 8.1) before removing it.

### Setting the Type of the File to Be Saved to DATA

1. Press **FILE**.
2. Press the **ITEM SELECT** soft key. The soft key menu switches.
3. Press the **DATA** soft key. DATA is selected, and the screen returns to the previous stage.
4. Press the **WRITE** soft key. The file list is displayed.

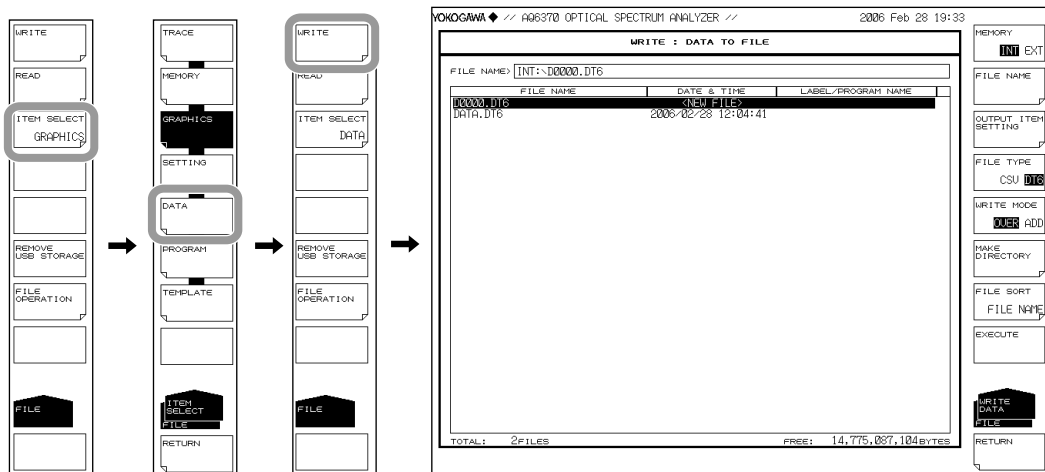

### Selecting the Save Destination Medium and Data Format

5. Press the **MEMORY** soft key and specify INT (internal memory) or EXT (USB storage medium). A file list of the selected medium is displayed.
6. Press the **FILE TYPE** soft key and specify a data format of DT6 (ASCII) or CSV (ASCII format).

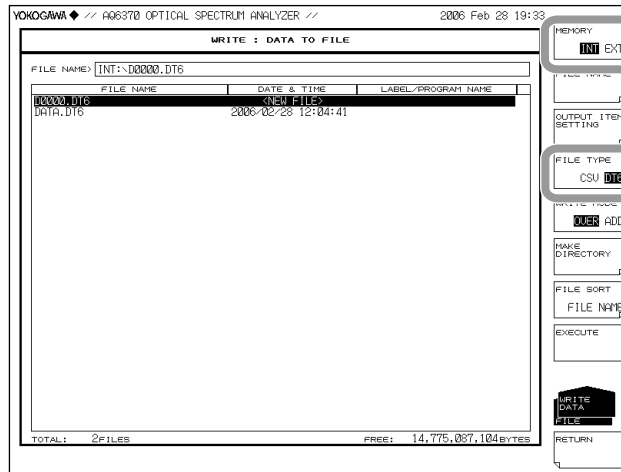

### Selecting Data Items to Save

7. Press the **OUTPUT ITEM SETTING** soft key. The menu for selecting data items to be saved is displayed.
8. Press the **Data Item** soft key and specify ON (save) or OFF (do not save).

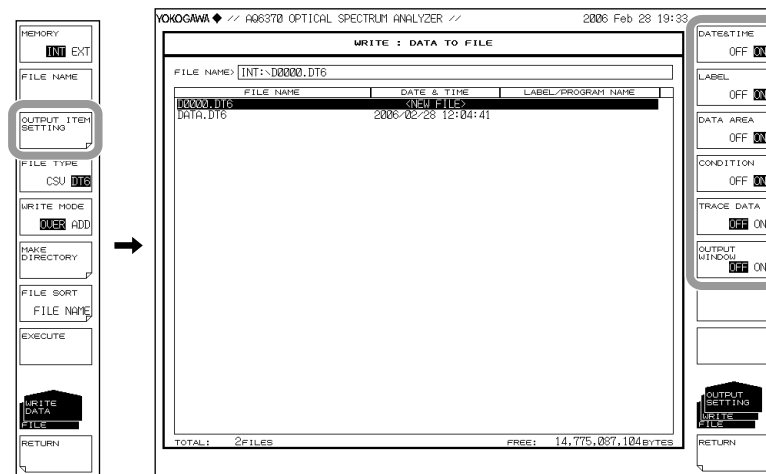

### Entering the Name of the File to Be Saved

If a file name is not entered, it is automatically assigned in the form DXXXX.DT6 or DXXXX.CSV (where XXXX is a serial number starting from 0000).  
 For creating a directory and sorting the file list, see the page 8-9.

9. Using the **rotary knob** or **arrow keys**, move the cursor to the line in the file list displaying NEW FILE.
10. Press the **FILE NAME** soft key. The text entry window and corresponding soft key menu are displayed.
- 11 Follow the instructions in section 4.3 to enter a file name.
12. Press the **DONE** soft key. The file name is confirmed, and the screen returns to the previous stage.

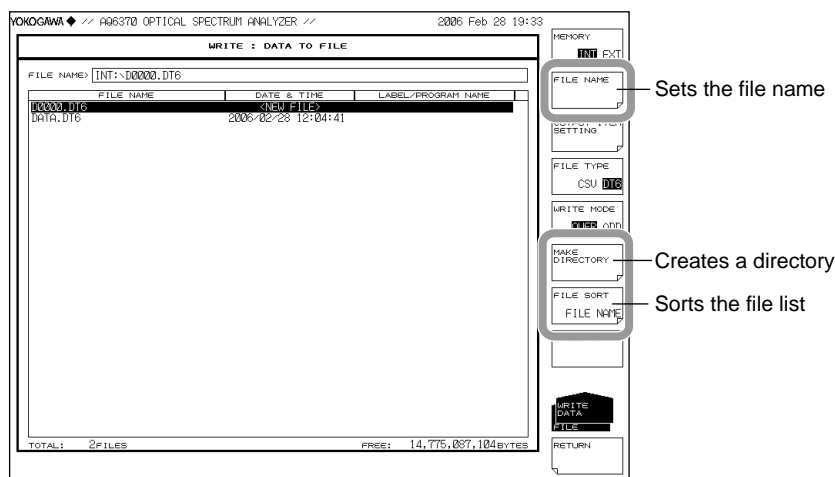

### Setting the Save Method and Executing the Save

13. Press the **WRITE MODE** soft key and specify OVER (overwrite) or ADD (add).
14. To overwrite an existing file, move the cursor to the file name to be overwritten.
15. Press the **EXECUTE** soft key. The save executes.  
 When the **RETURN** soft key is pressed, the data is saved. The screen returns to the previous menu.
16. When overwriting during a save, a confirmation message appears. Press the YES soft key. To cancel the save press NO soft key.

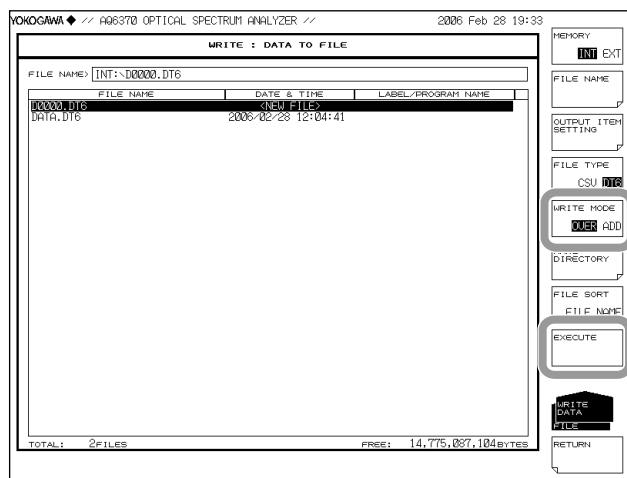

## Loading Analysis Data

### Setting the Type of the File to Be Loaded to DATA

1. Press **FILE**.
2. Press the **ITEM SELECT** soft key. The soft key menu switches.
3. Press the **DATA** soft key. DATA is selected, and the screen returns to the previous stage.
4. Press the **READ** soft key. The file list is displayed.

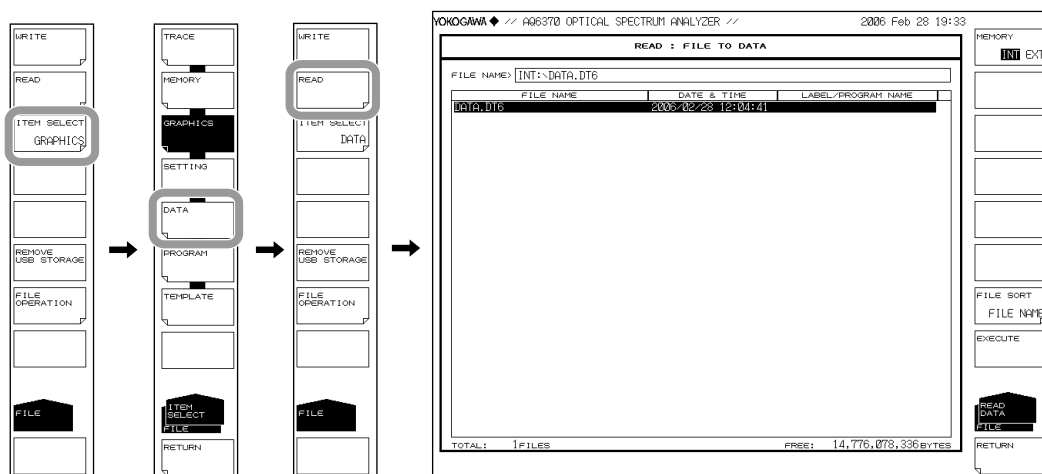

### Selecting the File to Be Loaded

5. Press the **MEMORY** soft key and specify INT (internal memory) or EXT (USB storage medium). A file list of the selected medium is displayed.
6. Select a file to load from the file list using the **rotary knob** or the **arrow keys**. You can also press the **FILE SORT** soft key to sort the files. For more information, see page 8-9.

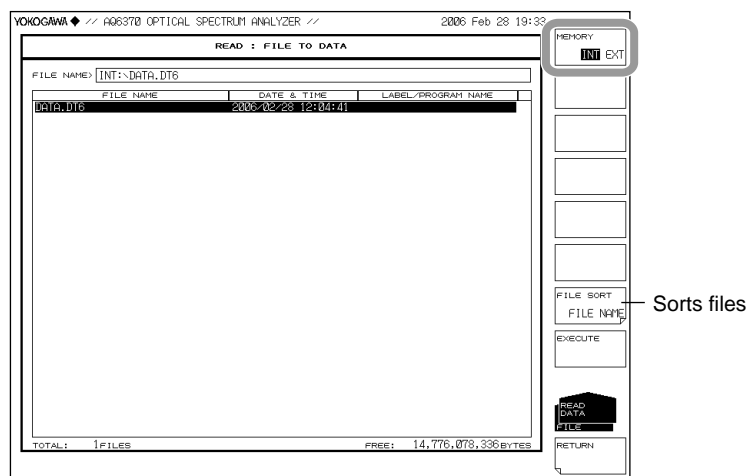

## 8.5 Saving/Loading Analysis Results Data

---

### Executing the Load

7. Press the **EXECUTE** soft key. The file is loaded.

When the **RETURN** soft key is pressed, the file is not loaded. The screen returns to the previous stage.

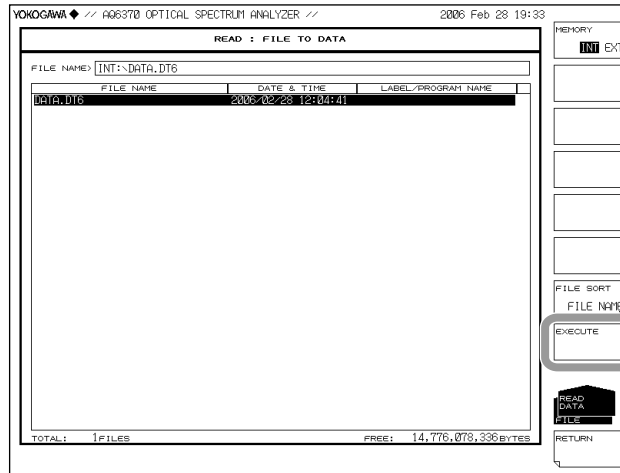

**Explanation****Extensions**

The extensions used when saving are as follows.

DAT (ASCII format): .DT6

CSV (ASCII format): .CSV

**File Name**

You can have a file name automatically assigned, or specify an arbitrary name for the save. If you do not assign a file name, a file name is automatically assigned as follows.

File name: DXXXX.CSV (or .DT6)

XXXX is a serial number from 0000 to 9999

**Note**

Only use the characters allowed in file names by MS-DOS when changing a file name. The maximum file name length is 56 characters (including the extension).

The following characters can be used in file names.

!#\$%&'()-

0123456789@

ABCDEFGHIJKLMNOPQRSTUVWXYZ^

abcdefghijklmnopqrstuvwxyz}`

**Saveable Data**

The following data can be saved.

Saved Item	Initial Value	Description
DATE&TIME	ON	Date and time
LABEL	ON	Label
DATA AREA	ON	Data area value
CONDITION	ON	Measurement conditions
TRACE DATA	OFF	Trace data
OUTPUT WINDOW	OFF	Output window data used by program function

**File Size**

The file size differs depending on the data saved. Be sure to check whether sufficient space is available before saving.

**File Sort**

You can sort the file list in ascending order by file name, file type, file date, or label.

**Overwrite Method**

If files of the same name reside in the save destination, you can select whether to overwrite them or add the data.

OVER: Overwrites the file.

ADD: Adds the data to be saved to the existing file data.

**8.5 Saving/Loading Analysis Results Data**

---

**Data Format**

You can save in ASCII format.

**DT6**

Saves as text data.

**CSV**

Saves the file in CSV (comma separated value) ASCII format.

**Data Format**

DT6 format is as follows.

```
"70DAT "
"
2006 Apr 07 16:42
"<NF ANALYSIS> TH:20.00dB MODE DIFF:3.00dB OFST(IN):0.00dB OFST(OUT):0.00dB"
" ASE ALGO:AUTO-FIX FIT AREA:AUTO MASK AREA:--- FIT ALGO:LINEAR "
" NO.   WAVELENGTH INPUT LVL OUTPUT LVL ASE LVL RESOLN  GAIN   NF"
"      [nm]         [dBm]   [dBm]   [dBm]  [nm]   [dB]   [dB]"
"  1    1544.4983   -29.320 -2.260  -22.281 0.102  27.017 8.533
"  2    1545.3041   -29.530 -2.420  -22.184 0.101  27.064 8.619
"
"CTRWL 1551.670000"
"SPAN  20.000000"
"REFL -10.0 dBm"
"LSCL 10.0"
"RESLN 0.100"
"AVG", 1
"SMPL 2001"
"HIGH 2"
"NMSK OFF"
1541.6700, -23.200
..... ..
```

Label

Date/time of save

Header and data analysis results

Measurement condition parameter

Sampling point portion of the waveform data (wavelength and level value)

CSV format is as follows.

```

70DAT2
TEST
2005 Apr 07 16:42
<NF ANALYSIS>
TH[dB],20.00
MODE DIFF[dB],3.00
OFST(IN)[dB],0.00
OFST(OUT)[dB],0.00
ASE ALGO,AUTO-FIX
FIT AREA,AUTO
MASK AREA,---
FIT ALGO,LINEAR
NO.,WAVELENGTH[nm],INPUT LVL[dBm],OUTPUT LVL[dBm],
ASE LVL[dBm],RESOLN[nm],GAIN[dB],NF[dB]
1,1544.4983,-29.320,-2.260,-22.281,0.102,27.017,8.533
2,1545.3041,-29.530,-2.420,-22.184,0.101,27.064,8.619
CTRWL,1551.670000
SPAN,20.000000
REFL[dBm],-10.0
LSCL,10.0
RESLN,0.100
AVG,1
SMPL,2001
HIGH 2
NMSK,OFF
1541.6700, -23.200

```

Label  
 Date/time data saved  
 Analysis results header and data  
 Measurement condition parameter  
 Sampling point portion of the waveform data (wavelength and level value)

## 8.6 Saving/Loading Program Data

### Procedure

Programs created with the program function are saved in binary format.

### CAUTION

Do not remove the USB storage medium or turn the power OFF while the USB storage medium access indicator is blinking. This can damage the data on the medium or the device itself. Also, always place a USB storage medium in the removable state (following the procedure in section 8.1) before removing it.

### Setting the Type of the File to Be Saved to PROGRAM

1. Press **FILE**.
2. Press the **ITEM SELECT** soft key. The soft key menu switches.
3. Press the **PROGRAM** soft key. PROGRAM is selected, and the screen returns to the previous stage.
4. Press the **WRITE** soft key to display the program list and file list.

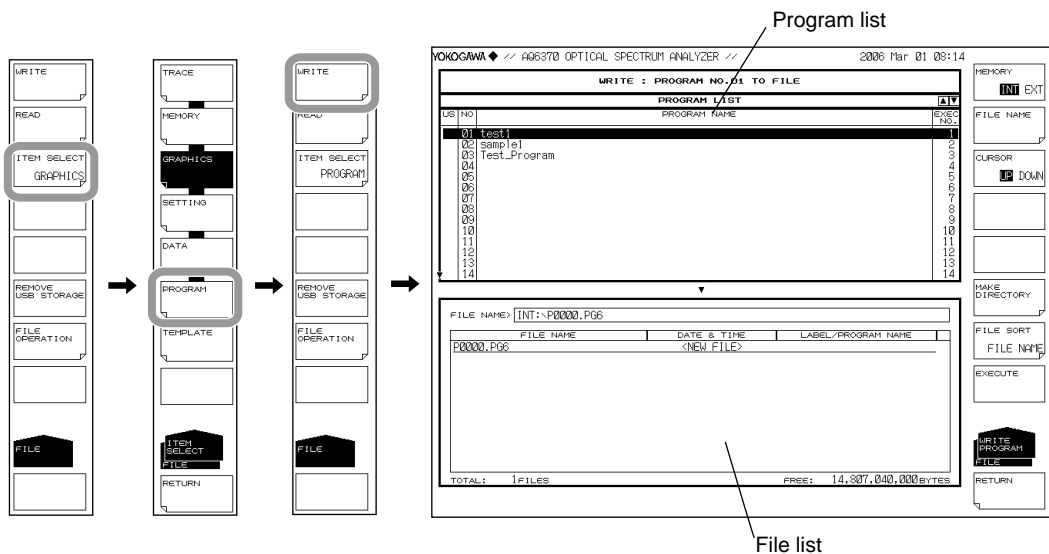

### Selecting the Save Destination and Data Format

5. Press the **MEMORY** soft key and specify a save destination of INT (internal memory) or EXT (USB storage medium).



### Selecting a Memory Number to Save

6. Press the **CURSOR** soft key, then set the cursor selection to UP (on the program list side).
7. Select the program number of the data to save using the **rotary knob**, **arrow keys**, or **numeric key pad**.

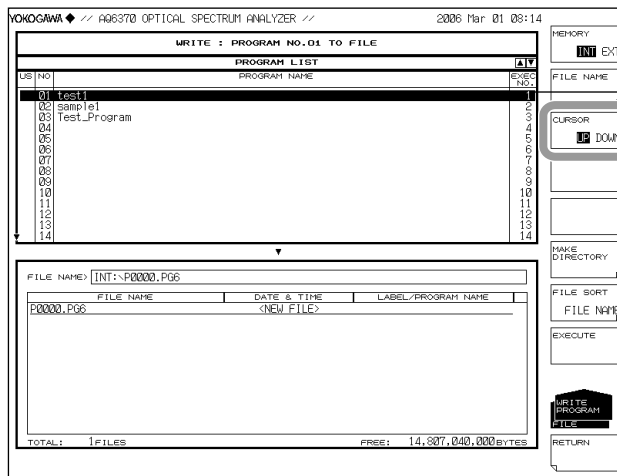

Selected program number

### Entering the Name of the File to Be Saved

If a file name is not entered, it is automatically assigned in the form PXXXX.PG6 (where XXXX is a serial number starting from 0000).

For creating a directory and sorting the file list, see the page 8-9.

8. Press the **CURSOR** soft key, then set the cursor selection to DOWN (on the file list side). An underscore is displayed with the program number selected in step 7.
9. Using the **rotary knob** or **arrow keys**, move the cursor to the line in the file list displaying NEW FILE.
10. Press the **FILE NAME** soft key. The text entry window and corresponding soft key menu are displayed.
- 11 Follow the instructions in section 4.3 to enter a file name.
12. Press the **DONE** soft key. The file name is confirmed, and the screen returns to the previous stage.

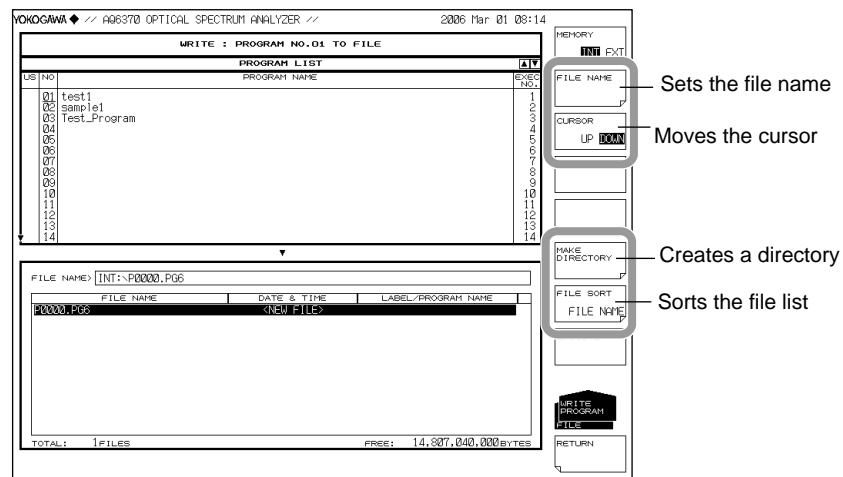

### Executing the Save

13. To overwrite an existing file, move the cursor to the file name to be overwritten.
14. Press the **EXECUTE** soft key. The save executes.  
When the **RETURN** soft key is pressed, the data is saved. The screen returns to the previous menu.
15. When overwriting during a save, a confirmation message appears. Press the **YES** soft key. To cancel the save press **NO** soft key.

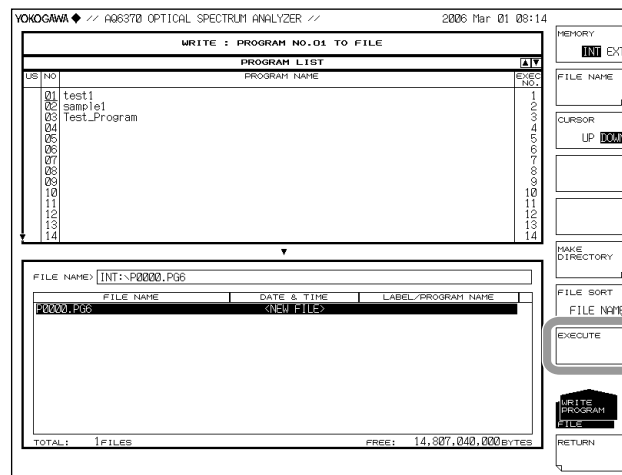

## Loading a Program File

### Setting the Type of the File to Be Loaded to PROGRAM

1. Press **FILE**.
2. Press the **ITEM SELECT** soft key. The soft key menu switches.
3. Press the **PROGRAM** soft key. PROGRAM is selected, and the screen returns to the previous stage.
4. Press the **READ** soft key. The program list is displayed.

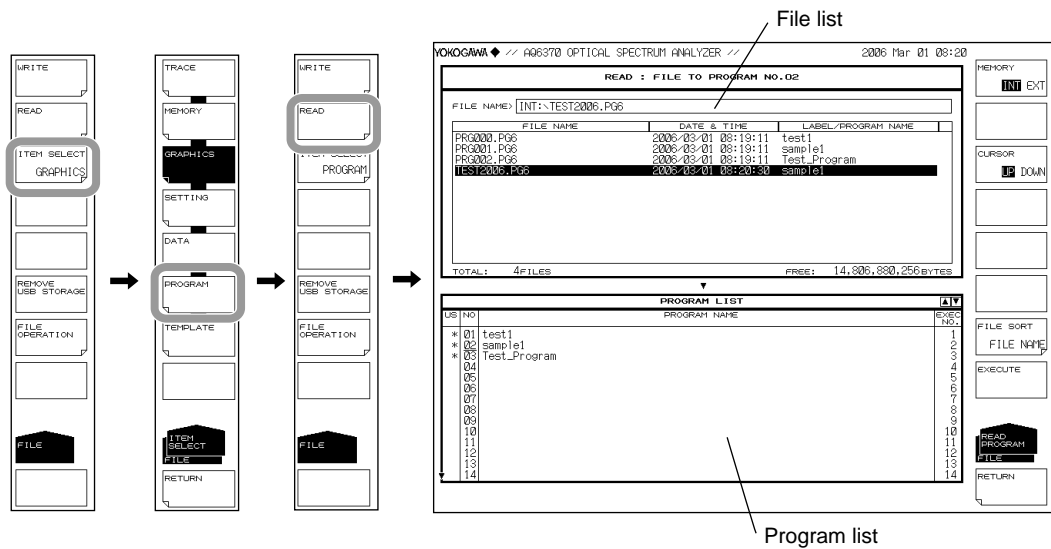

### Selecting the File to Be Loaded

5. Press the **MEMORY** soft key and specify INT (internal memory) or EXT (USB storage medium). A file list of the selected medium is displayed.
6. Press the **CURSOR** soft key, then set the cursor selection to UP (on the file list side).
7. Select a file to load from the file list using the **rotary knob** or the **arrow keys**.  
You can also press the **FILE SORT** soft key to sort the files. For more information, see page 8-9.

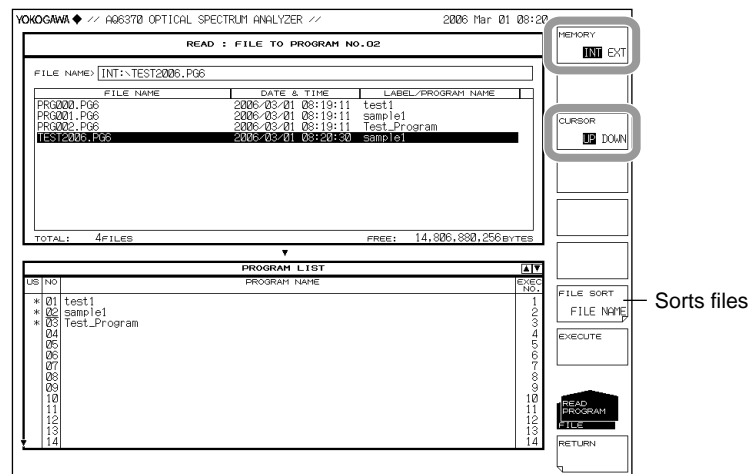

Selecting a Program Number to Save

8. Press the **CURSOR** soft key, then set the cursor selection to DOWN (on the program list side).
9. Select the program number of the load destination using the **rotary knob**, **arrow keys**, or **numeric key pad**.

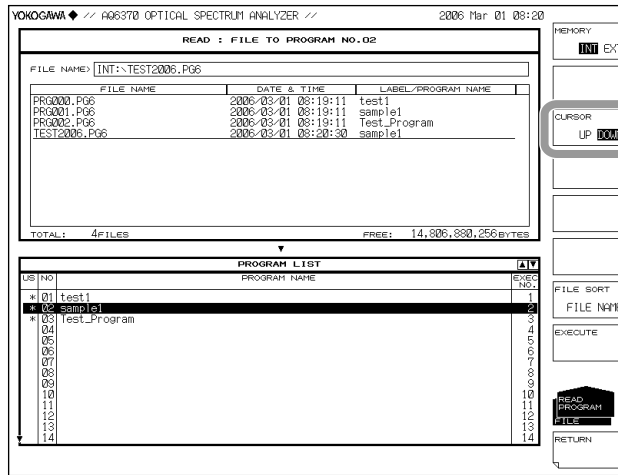

Executing the Load

10. Press the **EXECUTE** soft key. The file is loaded and registered to the specified program number.

When the **RETURN** soft key is pressed, the file is not loaded. The screen returns to the previous stage.

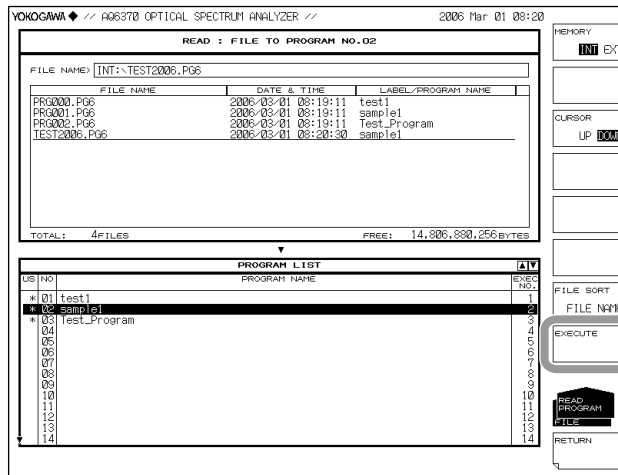

**Explanation****Extension**

The extension used when saving is as follows.

BIN (binary format): .PG6

**File Name**

You can have a file name automatically assigned, or specify an arbitrary name for the save. If you do not assign a file name, a file name is automatically assigned as follows.

File name: PXXXX.PG6

XXXX is a serial number from 0000 to 9999

**Note**

Only use the characters allowed in file names by MS-DOS when changing a file name. The maximum file name length is 56 characters (including the extension).

The following characters can be used in file names.

!#\$%&'()-

0123456789@

ABCDEFGHIJKLMNOPQRSTUVWXYZ^

abcdefghijklmnopqrstuvwxyz{|}~

**File Size**

The file size is approximately 13 KB.

**Data Format**

Saves the file in binary format.

## 8.7 Saving Screen Image Data

### Procedure

You can save the screen as an image file.

### CAUTION

Do not remove the USB storage medium or turn the power OFF while the USB storage medium access indicator is blinking. This can damage the data on the medium or the device itself. Also, always place a USB storage medium in the removable state (following the procedure in section 8.1 before removing it).

### Setting the Type of the File to Be Saved to GRAPHIC

1. Press **FILE**.
2. Press the **ITEM SELECT** soft key. The soft key menu switches.
3. Press the **GRAPHIC** soft key. GRAPHIC is selected, and the screen returns to the previous stage.
4. Press the **WRITE** soft key to display the file list.

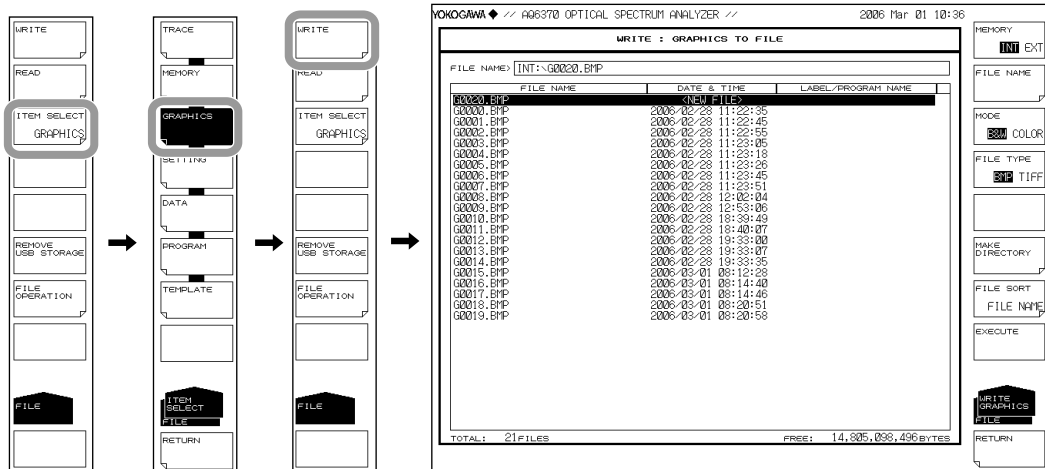

## Selecting the Save Destination and Data Format

- Press the **MEMORY** soft key and specify a save destination of INT (internal memory) or EXT (USB storage medium).



## Selecting the Color and File Format

- Press the **MODE** soft key and specify B&W (black and white) or COLOR.
- Press the **FILE TYPE** soft key to select BMP or TIFF.

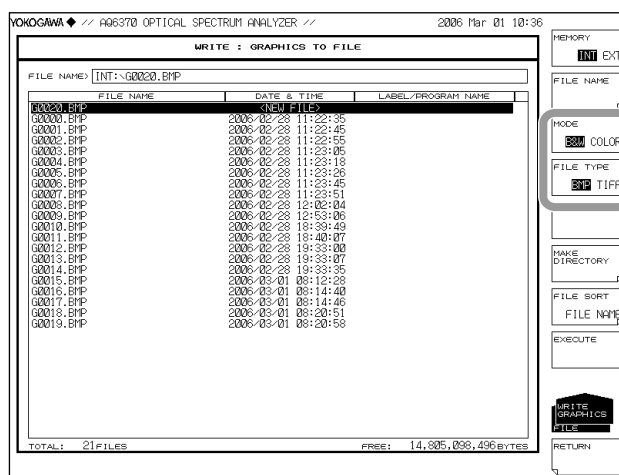

### Entering the Name of the File to Be Saved

If a file name is not entered, it is automatically assigned in the form GXXXX.BMP or GXXXX.TIF (where XXXX is a serial number starting from 0000).

For creating a directory and sorting the file list, see the page 8-9.

8. Press the **CURSOR** soft key, then set the cursor selection to DOWN (on the file list side). An underscore is displayed with the program number selected in step 7.
9. Using the **rotary knob** or **arrow keys**, move the cursor to the line in the file list displaying NEW FILE.
10. Press the **FILE NAME** soft key. The text entry window and corresponding soft key menu are displayed.
- 11 Follow the instructions in section 4.3 to enter a file name.
12. Press the **DONE** soft key. The file name is confirmed, and the screen returns to the previous stage.

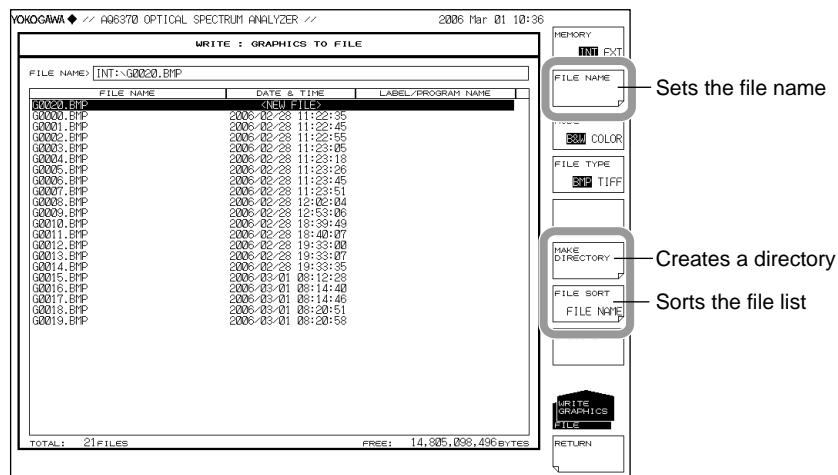

### Executing the Save

14. To overwrite an existing file, move the cursor to the file name to be overwritten.
15. Press the **EXECUTE** soft key. The save executes.  
When the **RETURN** soft key is pressed, the data is saved. The screen returns to the previous stage.
16. When overwriting during a save, a confirmation message appears. Press the YES soft key. To cancel the save press NO soft key.

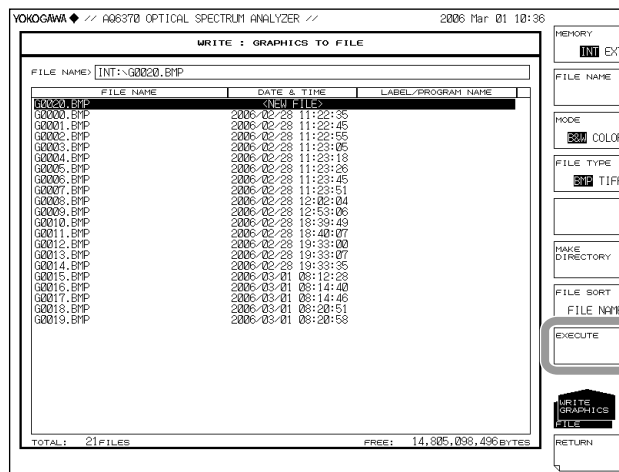

**Explanation****Extensions**

The extensions used when saving are as follows.

BMP (bit-mapped format): .BMP

TIFF: .TIF

**File Name**

You can have a file name automatically assigned, or specify an arbitrary name for the save. If you do not assign a file name, a file name is automatically assigned as follows.

File name: GXXXX.BMP or GXXXX.TIF

XXXX is a serial number from 0000 to 9999

**Note**

Only use the characters allowed in file names by MS-DOS when changing a file name. The maximum file name length is 56 characters (including the extension).

The following characters can be used in file names.

!#\$%&'()-

0123456789@

ABCDEFGHIJKLMNOPQRSTUVWXYZ^

abcdefghijklmnopqrstuvwxyz}`

**Color**

You can save the file in black and white or color.

**Data Format**

You can save the file as a bit-mapped (BMP) or TIFF file.

**File Size**

The file size differs depending on the data format and color specified.

BMP (color): Differs depending on the display color.

BMP (B&W): Approximately 52 KB

TIFF (color): Approximately 412 KB

TIFF (black & white): Approximately 52 KB

## 8.8 Saving/Loading Template Data

### Procedure

You can save or load template file in CSV format.

### CAUTION

Do not remove the USB storage medium or turn the power OFF while the USB storage medium access indicator is blinking. This can damage the data on the medium or the device itself. Also, always place a USB storage medium in the removable state (following the procedure in section 8.1) before removing it.

### Setting the Type of the File to Be Saved to TEMPLATE

1. Press **FILE**.
2. Press the **ITEM SELECT** soft key. The soft key menu switches.
3. Press the **TEMPLATE** soft key. **TEMPLATE** is selected, and the screen returns to the previous stage.
4. Press the **WRITE** soft key to display the template list and file list.

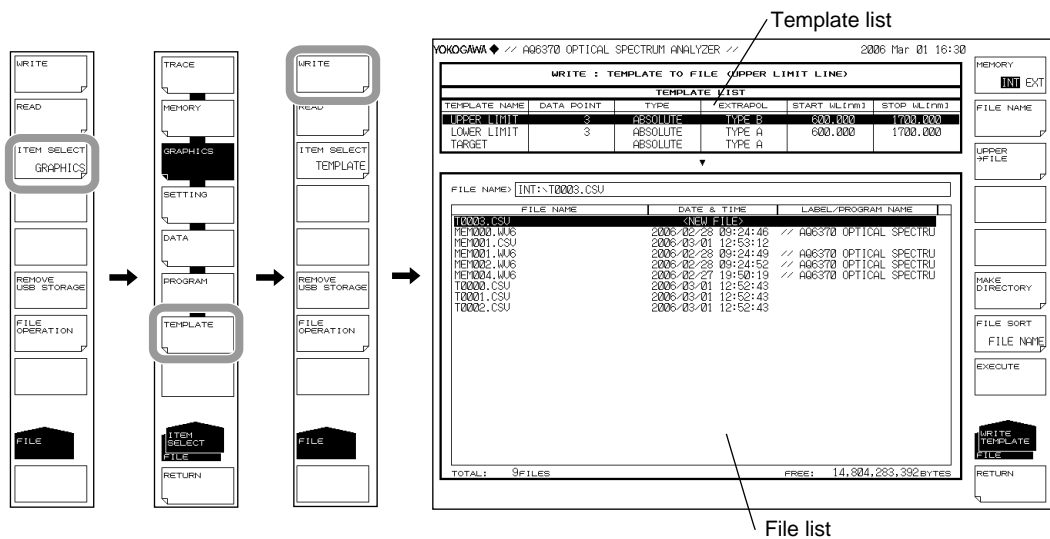

### Selecting the Save Destination and Data Format

5. Press the **MEMORY** soft key and specify a save destination of INT (internal memory) or EXT (USB storage medium).



### Selecting a Template to Save

6. Press the **@@@->FILE** soft key (where @@@ is UPPER, LOWER, or TARGET). The template selection screen appears.
7. Press the soft key corresponding to the template to be saved.

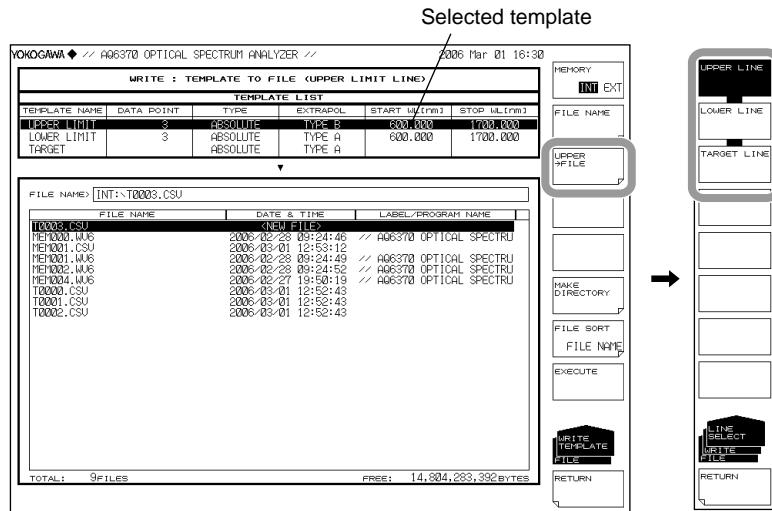

### Entering the Name of the File to Be Saved

If a file name is not entered, it is automatically assigned in the form TXXXX.CSV (where XXXX is a serial number starting from 0000).

For creating a directory and sorting the file list, see the page 8-9.

8. Press the **CURSOR** soft key, then set the cursor selection to DOWN (on the file list side). An underscore is displayed with the program number selected in step 7.
9. Using the **rotary knob** or **arrow keys**, move the cursor to the line in the file list displaying NEW FILE.
10. Press the **FILE NAME** soft key. The text entry window and corresponding soft key menu are displayed.
- 11 Follow the instructions in section 4.3 to enter a file name.
12. Press the **DONE** soft key. The file name is confirmed, and the screen returns to the previous stage.

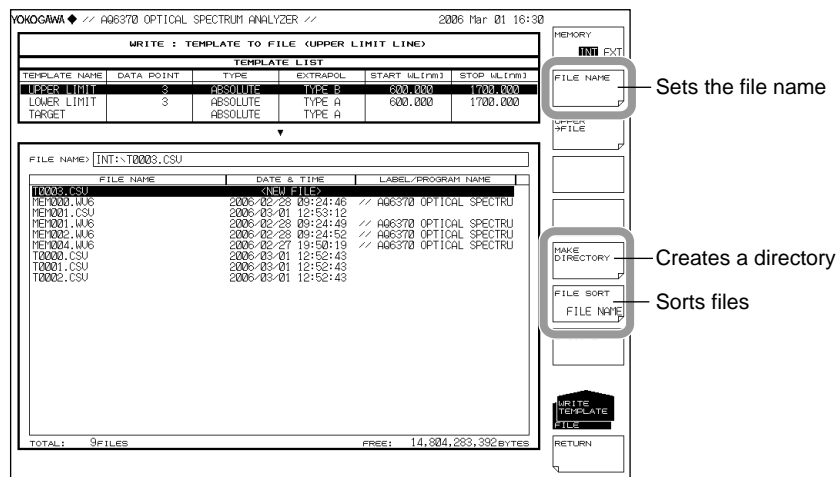

### Executing the Save

13. To overwrite an existing file, move the cursor to the file name to be overwritten.
14. Press the **EXECUTE** soft key. The save executes.  
When the **RETURN** soft key is pressed, the data is saved. The screen returns to the previous stage.
15. When overwriting during a save, a confirmation message appears. Press the **YES** soft key. To cancel the save press **NO** soft key.

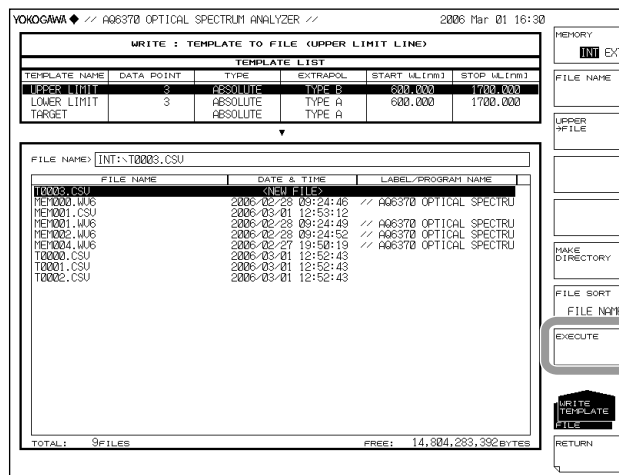

## Loading a Template File

### Setting the Type of the File to Be Loaded to TEMPLATE

1. Press **FILE**.
2. Press the **ITEM SELECT** soft key. The soft key menu switches.
3. Press the **TEMPLATE** soft key. **TEMPLATE** is selected, and the screen returns to the previous stage.
4. Press the **READ** soft key. The template list is displayed.

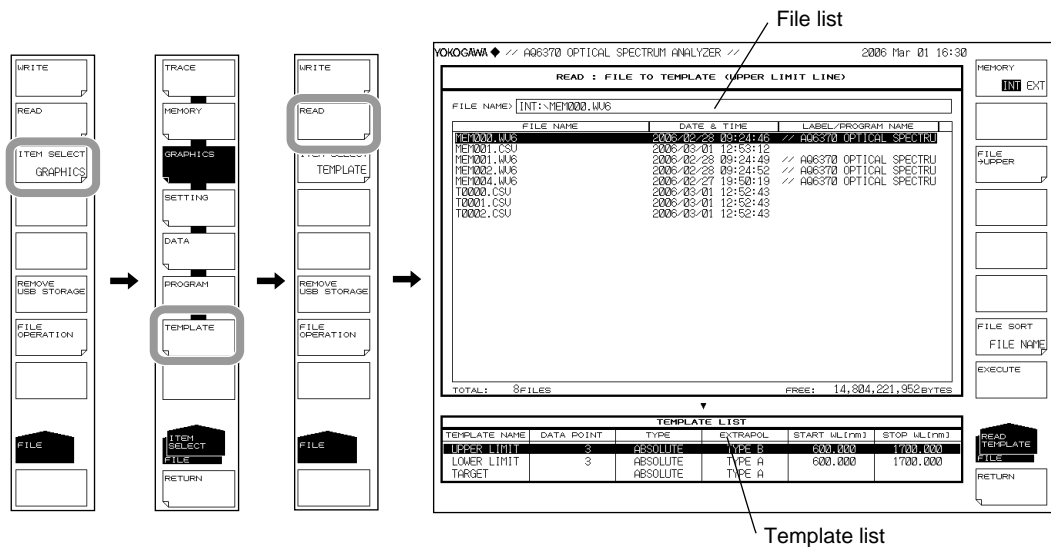

### Selecting the File to Be Loaded

5. Press the **MEMORY** soft key and specify **INT** (internal memory) or **EXT** (USB storage medium). A file list of the selected medium is displayed.
6. Select a file to load from the file list using the **rotary knob** or the **arrow keys**. You can also press the **FILE SORT** soft key to sort the files. For more information, see page 8-9.

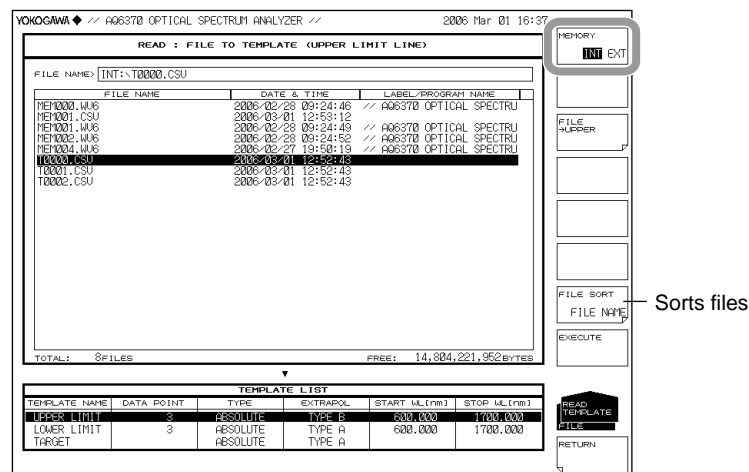

## 8.8 Saving/Loading Template Data

### Selecting a Template

8. Press the **FILE->@@@** soft key (where @@@ is UPPER, LOWER, or TARGET). The template selection screen appears.
9. Press the soft key corresponding to the template to be loaded to.

YOKOGAWA // A66370 OPTICAL SPECTRUM ANALYZER // 2006 Mar 01 16:37

READ : FILE TO TEMPLATE (UPPER LIMIT LINE)

FILE NAME: [INT:\T0000.CSU]

FILE NAME	DATE & TIME	LABEL/PROGRAM NAME
MEM000.MUS	2006-02-28 09:24:46	// A66370 OPTICAL SPECTRU
MEM001.CSU	2006-03-01 12:53:12	// A66370 OPTICAL SPECTRU
MEM001.MUS	2006-02-28 09:24:49	// A66370 OPTICAL SPECTRU
MEM002.MUS	2006-02-28 09:24:52	// A66370 OPTICAL SPECTRU
MEM004.MUS	2006-02-27 19:50:19	// A66370 OPTICAL SPECTRU
T0000.CSU	2006-03-01 12:52:43	
T0001.CSU	2006-03-01 12:52:43	
T0002.CSU	2006-03-01 12:52:43	

TOTAL: 8 FILES FREE: 14,804,221,952 BYTES

TEMPLATE NAME	DATA POINT	TYPE	EXTRAPOL	START WL(nm)	STOP WL(nm)
UPPER LIMIT	3	ABSOLUTE	TYPE B	600.000	1700.000
LOWER LIMIT	3	ABSOLUTE	TYPE A	600.000	1700.000
TARGET		ABSOLUTE	TYPE A		

SOFT KEYS: MEMORY, INT EXT, FILE UPPER, FILE SORT, FILE NAME, EXECUTE, READ TEMPLATE FILE, RETURN.

Vertical stack of soft keys: UPPER LINE, LOWER LINE, TARGET LINE, LINE SELECT, READ FILE, RETURN.

### Executing the Load

10. Press the **EXECUTE** soft key. The file is loaded as the specified template.
- When the **RETURN** soft key is pressed, the file is not loaded. The screen returns to the previous stage.

YOKOGAWA // A66370 OPTICAL SPECTRUM ANALYZER // 2006 Mar 01 16:37

READ : FILE TO TEMPLATE (UPPER LIMIT LINE)

FILE NAME: [INT:\T0000.CSU]

FILE NAME	DATE & TIME	LABEL/PROGRAM NAME
MEM000.MUS	2006-02-28 09:24:46	// A66370 OPTICAL SPECTRU
MEM001.CSU	2006-03-01 12:53:12	// A66370 OPTICAL SPECTRU
MEM001.MUS	2006-02-28 09:24:49	// A66370 OPTICAL SPECTRU
MEM002.MUS	2006-02-28 09:24:52	// A66370 OPTICAL SPECTRU
MEM004.MUS	2006-02-27 19:50:19	// A66370 OPTICAL SPECTRU
T0000.CSU	2006-03-01 12:52:43	
T0001.CSU	2006-03-01 12:52:43	
T0002.CSU	2006-03-01 12:52:43	

TOTAL: 8 FILES FREE: 14,804,221,952 BYTES

TEMPLATE NAME	DATA POINT	TYPE	EXTRAPOL	START WL(nm)	STOP WL(nm)
UPPER LIMIT	3	ABSOLUTE	TYPE B	600.000	1700.000
LOWER LIMIT	3	ABSOLUTE	TYPE A	600.000	1700.000
TARGET		ABSOLUTE	TYPE A		

SOFT KEYS: MEMORY, INT EXT, FILE UPPER, FILE SORT, FILE NAME, EXECUTE, READ TEMPLATE FILE, RETURN.

**Explanation****Extension**

The extension used when saving is .CSV.

**File Name**

You can have a file name automatically assigned, or specify an arbitrary name for the save. If you do not assign a file name, a file name is automatically assigned as follows.

File name: TXXXX.PG6

XXXX is a serial number from 0000 to 9999

**Note**

Only use the characters allowed in file names by MS-DOS when changing a file name. The maximum file name length is 56 characters (including the extension).

The following characters can be used in file names.

!#\$%&'()-

0123456789@

ABCDEFGHIJKLMNOPQRSTUVWXYZ^

abcdefghijklmnopqrstuvwxyz}`

**File Size**

The file size differs depending on the data.

**Data Format**

You can save the file in CSV format.

**Data Format**

AQ6370	}	Header indicating the AQ6370,
TEMPLATE,		Header indicating template data
TYPE,ABSOLUTE	}	Template type (ABSOLUTE or RELATIVE)
EXTRAPOL,A		Extrapolation type (A, B, or NONE)
1540.000,-20.00		Wavelength and level data
1550.000,-10.00		Data starting with the smallest wavelength
1560.000,-20.00		Sorts up to 50001 points of data

**Template Types**

The following types of templates are available for saving or loading.

UPPER: UPPER LINE  
 LOWER: LOWER LINE  
 TARGET: TARGET LINE

## 8.9 Creating Files

### Procedure

You can change file names, copy files, and perform other file manipulations.

### CAUTION

Do not remove the USB storage medium or turn the power OFF while the USB storage medium access indicator is blinking. This can damage the data on the medium or the device itself. Also, always place a USB storage medium in the removable state (following the procedure in section 8.1) before removing it.

### Selecting Medium of the File

1. Press **FILE**.
2. Press the **FILE OPERATION** soft key. The file operation menu is displayed.
3. Press the **MEMORY** soft key and specify **INT** (internal memory) or **EXT** (USB storage medium). A file list of the selected medium is displayed.

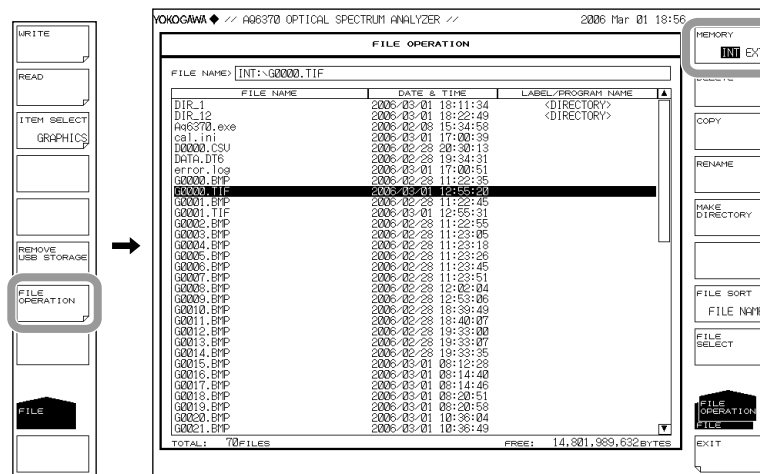

### Selecting the File/Directory

4. Select a file or directory using the **rotary knob** or the **arrow keys**. To move to a directory, select the directory and press **ENTER**. The instrument moves to the selected directory.

Select "." and press **ENTER** to move up one directory.

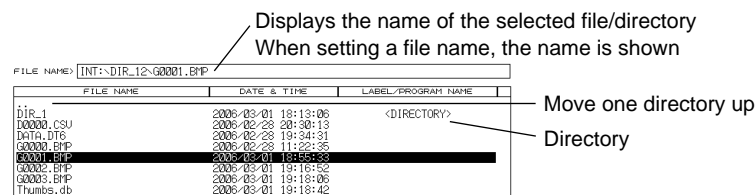

## Selecting All Files

5. Press the **FILE SELECT** soft key. The file selection menu is displayed.
  6. Press the **ALL SELECT** soft key. All files are selected.
- Press the **ALL CLEAR** soft key to clear the file selection.

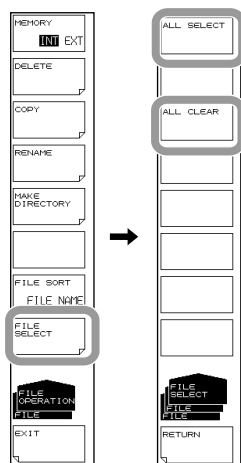

## Deleting a File/Directory

5. Select a file or directory to delete using the procedure in step 4.
6. Press the **DELETE** soft key. A deletion confirmation message appears.
7. Press the **YES** soft key. The selected file or directory is deleted. Press the **NO** soft key to cancel deletion of the file or directory. The screen returns to the previous state.

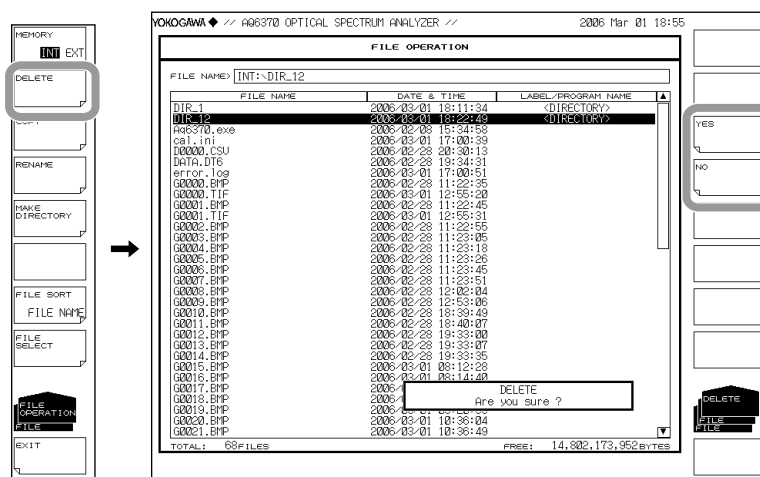

### Copying a File/Directory

5. Select a file or directory to copy using the procedure in step 4.
6. Press the **COPY** soft key.
7. Display the copy destination file list using steps 3 and 4. If the copy source and copy destination media are not the same, press the **MEMORY** soft key to select the copy destination medium.
8. When pasting to the same name, press the **EXECUTE** soft key. The selected file or directory is pasted.

When pasting under a different name from the copy source, press the **FILE NAME** soft key. The text entry window and corresponding soft key menu are displayed.

9. Follow the instructions in section 4.3 to enter a file name.
10. Press the **DONE** soft key. The file name is confirmed, and the screen returns to the previous stage.
11. Press the **EXECUTE** soft key. The data is pasted under the specified file or directory name. Press the **CANCEL** soft key to cancel changing of the file or directory name.

**Note**

When pasting in the same directory as the copy source, change the name before pasting.

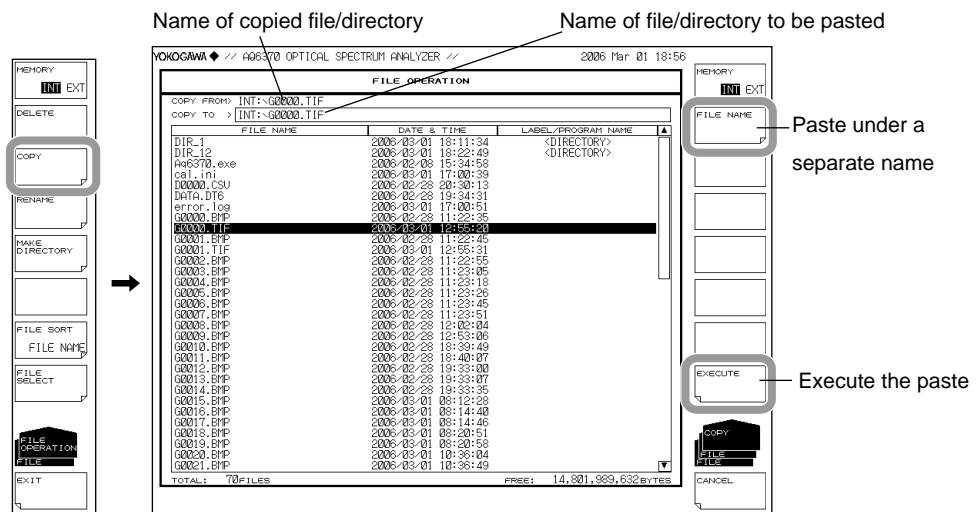

### Changing a File/Directory Name

5. Select a file or directory name to change using the procedure in step 4.
6. Press the **RENAME** soft key. The menu for setting names appears.
7. Press the **FILE NAME** soft key. The text entry window and corresponding soft key menu are displayed.
8. Follow the instructions in section 4.3 to enter a file name.
9. Press the **DONE** soft key. The file or directory name is confirmed, and the screen returns to the previous stage.
10. Press the **EXECUTE** soft key. The data is changed to the specified file or directory name. Press the **CANCEL** soft key to cancel changing of the file or directory name.

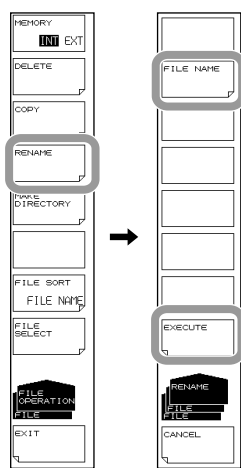

### Creating a Directory

5. Display the directory file list for creating directories using the procedure in step 4.
6. Press the **MAKE DIRECTORY** soft key. The menu for setting names appears.
7. Press the **DIRECTORY NAME** soft key. The text entry window and corresponding soft key menu are displayed.
8. Follow the instructions in section 4.3 to enter a directory name.
9. Press the **DONE** soft key. The directory name is confirmed, and the screen returns to the previous stage.
10. Press the **EXECUTE** soft key. A new directory is created. **Press the CANCEL** soft key to cancel creation of the directory.

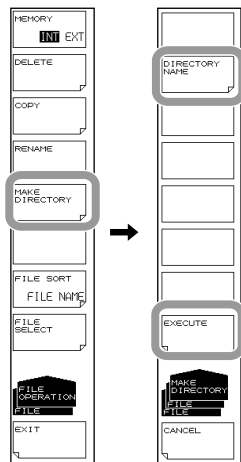

### Sorting Files

5. Press the **FILE SORT** soft key. The file sort menu is displayed.
6. Press the soft key corresponding to the item by which to sort. The files are sorted in ascending order by the selected item.

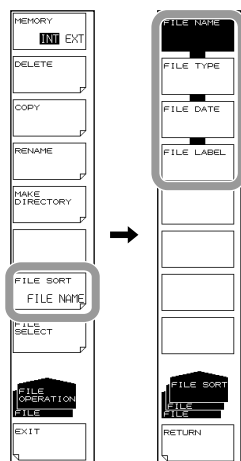

**Explanation****File/Directory Name**

When changing file/directory names, only use the characters allowed by MS-DOS for file and directory names. The maximum file name length is 56 characters (including the extension).

The following characters can be used in file names.

!#\$%&'()-

0123456789@

ABCDEFGHIJKLMNOPQRSTUVWXYZ^

abcdefghijklmnopqrstuvwxyz~

**File Sort**

You can sort the file list in ascending order by file name, file type, file date, or label.

# 9.1 Registering Soft keys

## Procedure

1. Press **SYSTEM**. The soft key menu regarding the system appears.
2. Press the **USER KEY DEFINE** soft key. A registration screen (USER KEY DEFINE MODE) key is displayed.  
To exit the soft key registration mode, press UNDO/LOCAL.
3. Press the panel key corresponding to the soft key to register.
4. Press the soft key to register. The name of the soft key you pressed is displayed in the registered key display area of the registration screen.
5. Press **USER**. The soft key menu switches to the USER menu.
6. Press soft key into which you wish to register the soft key selected in step 4. It switches to the name of the soft key to register. At the same time, the registration key display area goes blank again. If a soft key has already been registered, it is overwritten.
7. To clear a registered soft key, register a blank soft key using the same procedure.

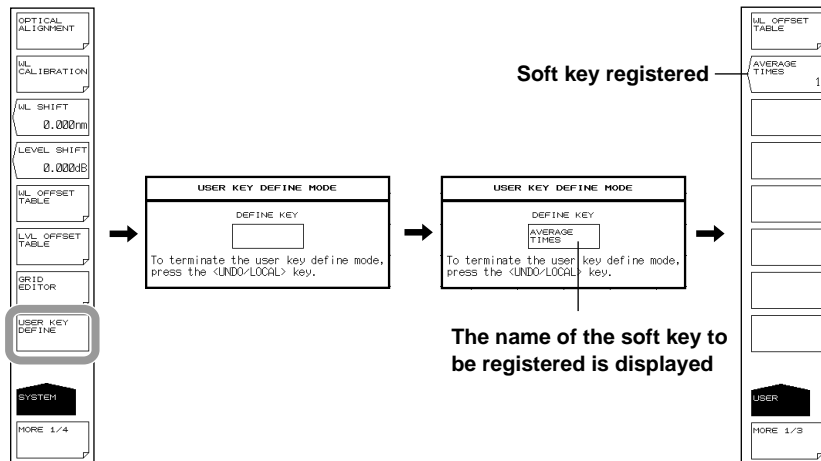

### Note

- In principle, only soft keys that are displayed after pressing a function key can be registered. Subsequent soft keys cannot be registered. Soft keys that cannot be registered are not displayed in the registered key display area.
- Like the soft keys of other function keys, registered soft keys execute actions based on the registered contents.

## Explanation

Any soft key can be registered as one of up to 24 user keys. Frequently used functions can be registered to a user soft key for easy access in the USER menu.

## 9.2 Data Initialization

### Procedure

1. Press **SYSTEM**. The soft key menu regarding the system appears.
2. Press the **MORE 1/4** soft key to display 4/4.
3. Press the **PARAMETER INITIALIZE** soft key. The initialization item setting menu is displayed.
4. Set the initialization type according to the items to be initialized.
5. Press the **EXECUTE** soft key. The initialization executes.  
To cancel, press the **CANCEL** soft key.

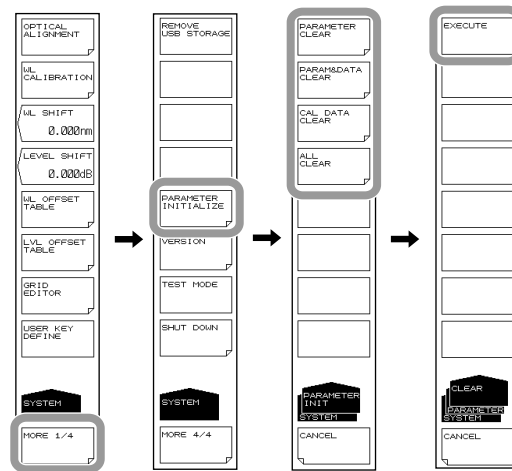

### Explanation

You can restore all settings to their factory defaults.

The following four types of initialization are available depending on the items to be initialized.

- **PARAMETER CLEAR**  
The parameter setting value of each function is initialized.  
Waveform data of TRACE A - G is also initialized.  
Use this to return the settings of the instrument to the already-known states.
- **PARAM&DATA CLEAR**  
Parameter setting values as well as data including MEMORY and PROGRAM are initialized.
- **CAL DATA CLEAR**  
Alignment adjustment values and wavelength calibration values are initialized.
- **ALL CLEAR**  
Current parameter setting values and data as well as alignment adjustment values and wavelength calibration values are initialized.

The initial values for each setting are shown below.

### SWEEP

Function	Initial Value	Maximum Value	Minimum Value
SEGMENT POINT****	1	50001	1
SWEEP MKR L1-L2 OFF/ON	OFF	-	-
SWEEP INTERVAL ****s	MINIMUM=0	99999	MINIMUM=0

### CENTER

Function	Initial Value	Maximum Value	Minimum Value
CENTER WL ****.***nm	1150.000	1700.000	600.000
CENTER FREQ ***.****THz	338.0013	500.0000	176.5000
START WL ****.***nm	600.000	1700.000	50.000
START FREQ ***.****THz	176.3485	500.0000	11.5000
STOP WL ****.***nm	1700.000	2250.000	600.000
STOP FREQ ***.****THz	499.6541	665.0000	176.5000
AUTO CENTER OFF/ON	OFF	-	-

### SPAN

Function	Initial Value	Maximum Value	Minimum Value
SPAN****.***nm	1100.0	1100.0	0 / 0.1
SPAN FREQ***.***THz	323.31	330.00	0.00
START WL ****.***nm	600.000	1700.000	50.000
START FREQ***.****THz	176.3485	500.0000	11.5000
STOP WL****.***nm	1700.000	2250.000	600.000
STOP FREQ***.****THz	499.6541	665.0000	176.5000
0nm SWEEP TIME**s	MINIMUM	50	MINIMUM

### LEVEL

Function	Initial Value	Maximum Value	Minimum Value
REF LEVEL	LOG	-10.0	30.0
	LINEAR	100μW	1000mW
LOG SCALE**.*dB/D	10.0 , ON	10.0	0.1
LIN SCALE	OFF	-	-
LIN BASE LEVEL**.*mW	0	REFx0.9	0
AUTO REF LEVEL OFF/ON	OFF	-	-
LEVEL UNIT dBm / dBm/nm / dBm/THz	dBm	-	-
Y SCALE SETTING	Y SCALE DIVISION 8/10/12	10	12
	REF LEVEL POSITION **DIV	8	12
SUB LOG**.*dB/D	5.0 , ON	10	0.1
SUB LIN*.**/D	0.125 , OFF	1.250	0.005
SUB SCALE**.*dB/km	5.0 , OFF	10.0	0.1
SUB SCALE**.*%/D	10.0 , OFF	125.0	0.5
OFFSET LEVEL **.*dB	0.0	99.9	-99.9
SCALE MIN *.*	0.00	1.25	0.00
OFFSET LEVEL **.*dB/km	0.0	99.9	-99.9
SCALE MIN **.*%	0.0	100.0	0.0
LENGTH**.*km	1.000	99.999	0.001
AUTO SUB SCALE OFF/ON	OFF	-	-
SUB REF LVL POSITION **DIV	5	10	0

## 9.2 Data Initialization

### SETUP

Function		Initial Value	Maximum Value	Minimum Value
RESOLUTION @@@@nm		1.000	2.000	0.020
SENS/MODE	NORM/HOLD	OFF	-	-
	NORM/AUTO	ON	-	-
	NORMAL	OFF	-	-
	MID	OFF	-	-
	HIGH1	OFF	-	-
	HIGH2	OFF	-	-
	HIGH3	OFF	-	-
CHOP MODE OFF/CHOP/SWITCH		OFF	-	-
AVG TIMES ***		1	999	1
SAMPLING POINT AUTO		ON	-	-
SAMPLING POINT *****		<SAMPLING POINT AUTO> calculated value, OFF	50001	101
SAMPLING INTERVAL *.****nm		<SAMPLING POINT AUTO> calculated value, OFF	SPAN/100	0.001
MEAS WL AIR/VACUUM		VAC	-	-
HORZN SCALE nm/THz		nm	-	-
EXT TRIGGER MODE OFF/ON		OFF	-	-
EXT TRIGGER SETTING	EDGE RISE/FALL	RISE	-	-
	DELAY ****.*µs	0.0	1000.0	0.0
RESOLN CORRECT OFF/ON		OFF	-	-
TLS SYNC SWEEP OFF/ON		OFF	-	-

### ZOOM

Function		Initial Value	Maximum Value	Minimum Value
ZOOM CENTER WL ****.*nm		Center wavelength during measurement of the trace that was measured or read last	1700.000	600.000
ZOOM CENTER FREQ ***.****THz		Center frequency during measurement of the trace that was measured or read last	500.0000	176.5000
ZOOM SPAN WL ****.*nm		Measurement span of the trace that was measured or read last	1100.0	0.1
ZOOM SPAN FREQ***.****THz		Measurement span of the trace that was measured or read last	330.0000	0.0100
ZOOM START WL ****.*nm		Measurement start wavelength of the trace that was measured or read last	1699.950	50.000
ZOOM START FREQ ***.****THz		Measurement start frequency of the trace that was measured or read last	499.9950	11.5000
ZOOM STOP WL ****.*nm		Measurement stop wavelength of the trace that was measured or read last	2250.000	600.050
ZOOM STOP FREQ ***.****THz		Measurement stop frequency of the trace that was measured or read last	665.0000	176.5050
OVERVIEW DISPLAY OFF/L/R		R	-	-
OVERVIEW SIZE LARGE/SMALL		LARGE	-	-

**DISPLAY**

Function		Initial Value	Maximum Value	Minimum Value
NORMAL DISPLAY		ON	-	-
SPLIT DISPLAY		OFF	-	-
SPLIT DISPLAY	TRACE A UP/LOW	UP	-	-
	TRACE B UP/LOW	UP	-	-
	TRACE C UP/LOW	LOW	-	-
	TRACE D UP/LOW	UP	-	-
	TRACE E UP/LOW	UP	-	-
	TRACE F UP/LOW	LOW	-	-
	TRACE G UP/LOW	LOW	-	-
HOLD	UPPER HOLD OFF/ON	OFF	-	-
	LOWER HOLD OFF/ON	OFF	-	-
LABEL		// AQ6370 OPTICAL SPECTRUM ANALYZER //	-	-
NOISE MASK ***dB		OFF	0	OFF(-999)
MASK LINE VERT / HRZN		HRZN	-	-

**TRACE**

Function		Initial Value	Maximum Value	Minimum Value	
ACTIVE TRACE A/B/C/D/E/F/G		TRACE A	-	-	
VIEW @ DISP/BLANK		TRACE A=DISP, TRACE B/C/D/E/F/G =BLANK	-	-	
FIX @		TRACE B/C/D/E/F/G	-	-	
HOLD @	MAX HOLD	No TRACE , TRACE A,C,E,G	-	-	
	MIN HOLD	No TRACE , TRACE B,D,F	-	-	
ROLL AVG *		No TRACE , 2	100	2	
CALCULATE C @@@@	LOG MATH @@@@	C=A-B(LOG) , ON	-	-	
	LIN MATH @@@@	C=A+B(LIN) , OFF	-	-	
CALCULATE F	LOG MATH @@@@	F=C-D(LOG) , ON	-	-	
	LIN MATH @@@@	F=C+D(LIN) , OFF	-	-	
CALCULATE G	LOG MATH @@@@	G=C-F(LOG) , ON	-	-	
	LIN MATH @@@@	G=C+F(LIN) , OFF	-	-	
	NORMALIZE @@@@	G=NORM A , OFF	-	-	
	CURVE FIT @@@@		G=CRVFIT A , OFF	-	-
		THRESH **dB	20	99	0
		OPERATION AREA ALL / INSIDE L1-L2 / OUTSIDE L1-L2	ALL	-	-
	FITTING ALGO		GAUSS	-	-
			G=PKCVFIT A , OFF	-	-
		THRESH **dB	20	99	0
	PEAK CURVE FIT @@@@	OPERATION AREA ALL / INSIDE L1-L2 / OUTSIDE L1-L2	ALL	-	-
FITTING ALGO		GAUSS	-	-	
TRACE COPY	SOURCE TRACE @	A	-	-	
	DESTINATION TRACE @	B	-	-	

## 9.2 Data Initialization

### MARKER

Function		Initial Value	Maximum Value	Minimum Value
MARKER ACTIVE OFF/ON		OFF	-	-
SET MARKER	SET	1	1024	1
LINE MARKER 1 OFF/ON		OFF	WL=1700.000 FREQ=499.65410	WL=600.000 FREQ=176.34850
LINE MARKER 2 OFF/ON		OFF	WL=1700.000 FREQ=499.65410	WL=600.000 FREQ=176.34850
LINE MARKER 3 OFF/ON		OFF	LOG=30.0 LINEAR=1000mW	LOG=-90.0 LINEAR=1.00pW
LINE MARKER 4 OFF/ON		OFF	LOG=30.0 LINEAR=1000mW	LOG=-90.0 LINEAR=1.00pW
MAKER DISPLAY OFFSET/SPACING		OFFSET	-	-
MARKER AUTO UPDATE OFF/ON		OFF	-	-
MARKER UNIT nm/THz		nm	-	-
SEARCH/ANA L1-L2 OFF/ON		OFF	-	-
SEARCH/ANA ZOOM AREA OFF/ON		ON	-	-

### PEAK SEARCH

Function		Initial Value	Maximum Value	Minimum Value
PEAK SEARCH		ON	-	-
BOTTOM SEARCH		OFF	-	-
SET MARKER		1	1024	1
AUTO SEARCH OFF/ON		OFF	-	-
MODE DIFF **. **dB		3.00	50.00	0.01
SEARCH/ANA L1-L2 OFF/ON		OFF	-	-
SEARCH/ANA ZOOM AREA OFF/ON		ON	-	-

### ANALYSIS

Function		Initial Value	Maximum Value	Minimum Value	
SPEC WIDTH @@@	THRESH	THRESH LEVEL *. **dB	3.00	50.00	0.01
		K	1.00	10.00	1.00
		MODE FIT OFF/ON	OFF	-	-
	ENVELOPE	THRESH LEVEL1 *. **dB	3.00	50.00	0.01
		THRESH LEVEL2 *. **dB	13.00	50.00	0.01
		K	1.00	10.00	1.00
	RMS	THRESH LEVEL *. **dB	20.00	50.00	0.01
		K	2.00	10.00	1.00
	PEAK RMS	THRESH LEVEL *. **dB	20.00	50.00	0.01
		K	2.00	10.00	1.00
	NOTCH	THRESH LEVEL *. **dB	3.00	50.00	0.01
		K	1.00	10.00	1.00
TYPE PAEK/BOTTOM		BOTTOM	-	-	

		Function	Initial Value	Maximum Value	Minimum Value	
ANALYSIS1@@@@@	DFB-LD	-XdB WIDTH	ALGO ENVELOPE/THRESH/RMS/PK-RMS	THRESH	-	-
			THRESH **.***dB	20.00	50.00	0.01
			THRESH2 **.***dB	20.00	50.00	0.01
			K	1.00	10.00	1.00
			MODE FIT OFF/ON	OFF	-	-
			MODE DIFF **.***dB	3.00	50.00	0.01
		SMSR	SMSR MODE SMSR1/SMSR2	SMSR1	-	-
			SMSR MASK ±**.***nm	0.00	99.99	0.00
			MODE DIFF **.***dB	3.00	50.00	0.01
		-XdB WIDTH	ALGO ENVELOPE/THRESH/RMS/PK-RMS	THRESH	-	-
			THRESH **.***dB	20.00	50.00	0.01
			THRESH2 **.***dB	20.00	50.00	0.01
	K		1.00	10.00	1.00	
	MODE FIT OFF/ON		OFF	-	-	
	MODE DIFF **.***dB		3.00	50.00	0.01	
	SMSR	SMSR MODE SMSR1/SMSR2	SMSR1	-	-	
		SMSR MASK ±**.***nm	0.00	99.99	0.00	
		MODE DIFF **.***dB	3.00	50.00	0.01	
	FP-LD	SPECTRUM WIDTH	ALGO ENVELOPE/THRESH/RMS/PK-RMS	PK-RMS	-	-
			THRESH **.***dB	20.00	50.00	0.01
			THRESH2 **.***dB	20.00	50.00	0.01
			K	2.00	10.00	1.00
			MODE FIT OFF/ON	OFF	-	-
			MODE DIFF **.***dB	3.00	50.00	0.01
MEAN WAVELENGTH		ALGO ENVELOPE/THRESH/RMS/PK-RMS	PK-RMS	-	-	
		THRESH **.***dB	20.00	50.00	0.01	
		THRESH2 **.***dB	20.00	50.00	0.01	
		K	2.00	10.00	1.00	
		MODE FIT OFF/ON	OFF	-	-	
		MODE DIFF **.***dB	3.00	50.00	0.01	
TOTAL POWER	OFFSET LEVEL **.***dB	0.00	10.00	-10.00		
MODE NO.	ALGO ENVELOPE/THRESH/RMS/PK-RMS	PK-RMS	-	-		
	THRESH **.***dB	20.00	50.00	0.01		
	THRESH2 **.***dB	20.00	50.00	0.01		
	K	2.00	10.00	1.00		
	MODE FIT OFF/ON	OFF	-	-		
	MODE DIFF **.***dB	3.00	50.00	0.01		
LED	SPECTRUM WIDTH	ALGO ENVELOPE/THRESH/RMS/PK-RMS	THRESH	-	-	
		THRESH **.***dB	3.00	50.00	0.01	
		THRESH2 **.***dB	20.00	50.00	0.01	
		K	1.00	10.00	1.00	
		MODE FIT OFF/ON	OFF	-	-	
		MODE DIFF **.***dB	3.00	50.00	0.01	
	MEAN WAVELENGTH	ALGO ENVELOPE/THRESH/RMS/PK-RMS	RMS	-	-	
		THRESH **.***dB	20.00	50.00	0.01	
		THRESH2 **.***dB	20.00	50.00	0.01	
		K	2.00	10.00	1.00	
		MODE FIT OFF/ON	OFF	-	-	
		MODE DIFF **.***dB	3.00	50.00	0.01	
TOTAL POWER	OFFSET LEVEL **.***dB	0.00	10.00	-10.00		

9.2 Data Initialization

		Function	Initial Value	Maximum Value	Minimum Value	
ANALYSIS1 @@@@	SMSR	SMSR MODE SMSR1/SMSR2	SMSR1	-	-	
		SMSR MASK ±**.***nm	0.00	99.99	0.00	
	POWER	OFFSET LEVEL **.***dB	0.00	10.00	-10.00	
	PMD	THRESH LEVEL **.***dB	3.00	50.00	0.01	
ANALYSIS2 @@@@	WDM	CHANNEL DETECTION SETTING	THRESH LEVEL **.***dB	3.00	50.00	0.01
			MODE DIFF **.***dB	3.00	50.00	0.01
			DISPLAY MASK OFF/**.***dB	OFF	0.0	-100.0
	WDM	INTERPOLATION SETTING	NOISE ALGO AUTO-FIX/MANUAL-FIX/ AUTO-CTR/MANUAL-CTR	AUTO-FIX	-	-
			NOISE AREA **.***nm	0.40	10.00	0.01
			MASK AREA **.***nm	0.20	10.00	0.01
			FITTING ALGO LINEAR/GAUSS/LORENZ/ 3RD POLY/4TH POLY/5TH POLY	LINEAR	-	-
			NOISE BW **.***nm	0.10	1.00	0.01
			DUAL TRACE OFF/ON	OFF	-	-
	WDM	DISPLAY SETTING	DISPLAY TYPE ABSOLUTE/RELATIVE/ DRIFT(MEAS)/DRIFT(GRID)	ABSOLUTE	-	-
			CH RELATION OFFSET/SPACING	OFFSET	-	-
			REF CH HIGHEST/****CH	HIGHEST	1024	1
			OUTPUT SLOPE OFF/ON	OFF	-	-
			POINT DISPLAY OFF/ON	ON	-	-
	EDFA-NF	CHANNEL DETECTION SETTING	THRESH LEVEL **.***dB	3.00	50.00	0.01
MODE DIFF **.***dB			3.00	50.00	0.01	
INTERPOLATION SETTING		OFFSET(IN) **.***dB	0.00	99.99	-99.99	
		OFFSET(OUT) **.***dB	0.00	99.99	-99.99	
		ASE ALGO LINEAR/GAUSS/LORENZ/ 3RD POLY/4TH POLY/5TH POLY	LINEAR	-	-	
		FITTING AREA **.***nm	0.40	10.00	0.01	
		MASK AREA **.***nm	0.20	10.00	0.01	
		FITTING ALGO LINEAR/GAUSS/LORENZ/ 3RD POLY/4TH POLY/5TH POLY	LINEAR	-	-	
		POINT DISPLAY OFF/ON	ON	-	-	

		Function	Initial Value	Maximum Value	Minimum Value	
ANALYSIS2 @@@@	FILTER-PK	PEAK LEVEL	SW OFF/ON	ON	-	-
		PEAK WAVELENGTH	SW OFF/ON	ON	-	-
		CENTER WAVELENGTH	SW OFF/ON	ON	-	-
			ALGO THRESH/RMS	THRESH	-	-
			THRESH LEVEL **.**dB	3.00	50.00	0.01
			K	1.00	10.00	1.00
			MODE FIT OFF/ON	OFF	-	-
		SPECTRUM WIDTH	MODE DIFF **.**dB	3.00	50.00	0.01
			SW OFF/ON	ON	-	-
			ALGO THRESH/RMS	THRESH	-	-
			THRESH LEVEL **.**dB	3.00	50.00	0.01
			K	1.00	10.00	1.00
		RIPPLE WIDTH	MODE FIT OFF/ON	OFF	-	-
			MODE DIFF **.**dB	3.00	50.00	0.01
			MODE DIFF **.***dB	0.500	50.000	0.001
	FILTER-PK	CROSS TALK	SW OFF/ON	ON	-	-
			ALGO THRESH/PK LEVEL/GRID	THRESH	-	-
			THRESH LEVEL **.**dB	3.00	50.00	0.01
			K	1.00	10.00	1.00
			MODE FIT OFF/ON	OFF	-	-
			MODE DIFF **.**dB	3.00	50.00	0.01
			CH SPACE ±**.**nm	0.40	50.00	0.00
			SEARCH AREA ±**.**nm	0.01	10.00	0.01
	FILTER-BTM	BOTTOM LEVEL	SW OFF/ON	ON	-	-
		BOTTOM WAVELENGTH	SW OFF/ON	ON	-	-
		CENTER WAVELENGTH	SW OFF/ON	ON	-	-
			ALGO PEAK/BOTTOM	BOTTOM	-	-
			THRESH LEVEL **.**dB	3.00	50.00	0.01
			MODE DIFF **.**dB	3.00	50.00	0.01
		NOTCH WIDTH	SW OFF/ON	ON	-	-
			ALGO PEAK/BOTTOM	BOTTOM	-	-
			THRESH LEVEL **.**dB	3.00	50.00	0.01
			MODE DIFF **.**dB	3.00	50.00	0.01

9.2 Data Initialization

		Function	Initial Value	Maximum Value	Minimum Value		
ANALYSIS2@@@	FILTER-BTM	CROSS TALK	SW OFF/ON	ON	-	-	
			ALGO PEAK/BOTTOM/BOTTOM LVL/ GRID	BOTTOM	-	-	
			THRESH LEVEL *.*dB	20.00	50.00	0.01	
			MODE DIFF *.*dB	3.00	50.00	0.01	
			CH SPACE ±*.*nm	0.40	50.00	0.00	
			SEARCH AREA ±*.*nm	0.01	10.00	0.01	
	WDM FIL-PK	CHANNEL DETECTION/ NOMINAL WAVELENGTH	ALGO PEAK/MEAN/GRID FIT/GRID	MEAN	-	-	
			THRESH LEVEL *.*dB	3.0	50.0	0.1	
			MODE DIFF *.*dB	3.0	50.0	0.1	
			TEST BAND *.*nm	0.100	9.999	0.001	
		PEAK WAVELENGTH/ LEVEL	SW OFF/ON	ON	-	-	
		XdB WIDTH / CENTER WAVELENGTH	SW OFF/ON	ON	-	-	
		XdB STOP BAND	SW OFF/ON	ON	-	-	
			THRESH LEVEL *.*dB	-10.000	30.000	-90.000	
		XdB PASS BAND	SW OFF/ON	ON	-	-	
			THRESH LEVEL *.*dB	3.0	50.0	0.1	
			TEST BAND *.*nm	0.20	99.99	0.01	
		RIPPLE	SW OFF/ON	ON	-	-	
			TEST BAND *.*nm	0.20	99.99	0.01	
		CROSS TALK	SW OFF/ON	ON	-	-	
			SPACING *.*nm	0.80	99.99	0.01	
			TEST BAND *.*nm	0.20	99.99	0.01	
		WDM FIL-BTM	CHANNEL DETECTION/ NOMINAL WAVELENGTH	ALGO BOTTOM/NOTCH(P)/NOTCH(B)/ GRID FIT/GRID	NOTCH(B)	-	-
				THRESH LEVEL *.*dB	20.0	50.0	0.1
MODE DIFF *.*dB	20.0			50.0	0.1		
TEST BAND *.*nm	0.100			9.999	0.001		

Function		Initial Value	Maximum Value	Minimum Value		
ANALYSIS2 @@@@	WDM FIL-BTM	BOTTOM WAVELENGTH / LEVEL	SW OFF/ON	ON	-	-
		XdB NOCH WIDTH / CENTER WAVELENGTH	SW OFF/ON	ON	-	-
			ALGORHYTHM NOTCH(P)/NOTCH(B)	NOTCH(B)	-	-
			THRESH LEVEL *.dB	3.0	50.0	0.1
		XdB STOP BAND	SW OFF/ON	ON	-	-
			THRESH LEVEL *.dB	-10.000	30.000	-90.000
		XdB ELIMINATION BAND	SW OFF/ON	ON	-	-
			THRESH LEVEL *.dB	3.0	50.0	0.1
			TEST BAND **.nm	0.20	99.99	0.01
		RIPPLE	SW OFF/ON	ON	-	-
			TEST BAND **.nm	0.20	99.99	0.01
		CROSS TALK	SW OFF/ON	ON	-	-
			SPACING **.nm	0.80	99.99	0.01
			TEST BAND **.nm	0.20	99.99	0.01
		SPEC WIDTH THRESH **.dB		3.00	50.00	0.01
		SWITCH DISPLAY TRACE&TABLE/TABLE/TRACE		TRACE&TABLE	-	-
		AUTO ANALYSIS OFF/ON		OFF	-	-
		SEARCH/ANA L1-L2 OFF/ON		OFF	-	-
SEARCH/ANA ZOOM AREA OFF/ON		ON	-	-		

## MEMORY

Function		Initial Value	Maximum Value	Minimum Value
SAVE	LIST PARAMETER LBL/ CONDTN	LBL	-	-
RECALL	LIST PARAMETER LBL/ CONDTN	LBL	-	-
CLEAR	LIST PARAMETER LBL/ CONDTN	LBL	-	-
MEMORY LIST	LIST PARAMETER LBL/ CONDTN	LBL	-	-

9.2 Data Initialization

**FILE**

Function		Initial Value	Maximum Value	Minimum Value		
WRITE	DRIVE INT/EXT		INT	-	-	
	TRACE	TRACE@ → FILE	A	-	-	
		FILE TYPE BIN/CSV	BIN	-	-	
	MEMORY	CURSOR UP/DOWN	DOWN	-	-	
		FILE TYPE BIN/CSV	BIN	-	-	
		LIST PARAMETER LBL/CONDTN	LBL	-	-	
	GRAPHICS	MODE B&W/ COLOR	COLOR	-	-	
		FILE TYPE BMP/TIFF	BMP	-	-	
	DATA	OUTPUT ITEM SETTING	DATE&TIME OFF/ON	ON	-	-
			LABEL OFF/ON	ON	-	-
			DATA AREA OFF/ON	ON	-	-
			CONDITION OFF/ON	ON	-	-
			TRACE DATA OFF/ON	OFF	-	-
			OUTPUT DISPLAY OFF/ON	OFF	-	-
		FILE TYPE CSV/DT5	CSV	-	-	
		WRITE MODE OVER/ADD	OVER	-	-	
	PROGRAM	CURSOR UP/DOWN	DOWN	-	-	
	TEMPLATE	@@@@→FILE	UPPER LINE	-	-	
	FILE SORT @@@@		FILE NAME	-	-	
	READ	DRIVE INT/EXT		INT	-	-
TRACE		FILE → TRACE @	A	-	-	
MEMORY		CURSOR UP/DOWN	DOWN	-	-	
FILE SORT @@@@@@@@@@		FILE NAME	-	-		
ITEM SELECT @@@@		TRACE	-	-		
FILE OPERATION	DRIVE INT/EXT		INT	-	-	
	COPY	DRIVE INT/EXT	INT	-	-	
	FILE SORT @@@@@@@@@@		FILE NAME	-	-	

**PROGRAM**

Function	Initial Value	Maximum Value	Minimum Value
EXECUTE1 **	01 (Program number)	-	-
EXECUTE2 **	02 (Program number)	-	-
EXECUTE3 **	03 (Program number)	-	-
EXECUTE4 **	04 (Program number)	-	-
EXECUTE5 **	05 (Program number)	-	-
EXECUTE6 **	06 (Program number)	-	-
EXECUTE7 **	07 (Program number)	-	-
EXECUTE8 **	08 (Program number)	-	-
EXECUTE9 **	09 (Program number)	-	-
EXECUTE10 **	10 (Program number)	-	-
EXECUTE11 **	11 (Program number)	-	-
EXECUTE12 **	12 (Program number)	-	-
EXECUTE13 **	13 (Program number)	-	-
EXECUTE14 **	14 (Program number)	-	-
EXECUTE15 **	15 (Program number)	-	-
EXECUTE16 **	16 (Program number)	-	-
EXECUTE17 **	17 (Program number)	-	-
EXECUTE18 **	18 (Program number)	-	-
EXECUTE19 **	19 (Program number)	-	-
EXECUTE20 **	20 (Program number)	-	-
EXECUTE21 **	21 (Program number)	-	-

**ADAVANCE**

Function	Initial Value	Maximum Value	Minimum Value
GO/NO GO OFF/ON	OFF	-	-
TEMPLATE DISPLAY	UPPER LINE DISPLAY OFF/ON	OFF	-
	LOWER LINE DISPLAY OFF/ON	OFF	-
	TARGET LINE DISPLAY OFF/ON	OFF	-
TEST TYPE @@@@	UPPER&LOWER	-	-
TEMPALTE EDIT	LINE SELECT @@@@	UPPER LINE	-
	MODE ABS/REL	ABS	-
	EXTRAPOL TYPE	TYPE A	-
TEMPLATE SHIFT	WL SHIFT**.*nm	0	999.999
	LEVEL SHIFT *.*dB	0	99.99

## 9.2 Data Initialization

### SYSTEM

Function		Initial Value	Maximum Value	Minimum Value	
WL CALIBRATION	BUILT-IN SOURCE	ON	-	-	
	EXTERNAL LASER ****.***nm	1523.488 , OFF	1700.000	600.000	
	EXTERNAL GAS CELL ****.***nm	1530.372 , OFF	1700.000	600.000	
WL SHIFT **.***nm		0.000	5.000	-5.000	
LEVEL SHIFT ***.***dB		0.000	60.000	-60.000	
GRID EDITOR	200GHz SPACING	ON	-	-	
	100GHz SPACING	OFF	-	-	
	50GHz SPACING	OFF	-	-	
	25GHz SPACING	OFF	-	-	
	12.5GHz SPACING	OFF	-	-	
	CUSTOM	START WL ****.***nm	1528.7734	1700.0000	1000.0000
		START WL ****.***THz	192.1000	299.7924	176.3486
		STOP WL ****.***nm	1560.6062	1700.0000	1000.0000
		STOP WL ****.***THz	196.1000	299.7924	176.3486
		SPACING **.*GHz	50.0	999.9	0.1
REFERENCE WAVELENGTH ****.***nm		1552.5244	1700.0000	1000.0000	
REFERENCE WAVELENGTH ****.***THz		193.1000	299.7924	176.3486	
REMOTE INTERFACE @@@@		GP-IB	-	-	
GP-IB SETTING	MY ADDRESS **	1	-	-	
	GP-IB2 PORT ADDRESS **	2	-	-	
	SYSTEM CONTROLLER OFF/ON	ON	-	-	
	COMMAND FORMAT @@@@	AQ6370	-	-	
	TLS ADDRESS	20	30	0	
RS-232C SETTING	BOUD RATE @@@@	9600BPS	115200BPS	1200BPS	
	PARITY @@@@	NONE	-	-	
	FLOW @@@@	NONE	-	-	
	COMMAND FORMAT @@@@	AQ6370	-	-	
NETWORK SETTING	TCP/IP SETTING	AUTO(DHCP)	-	-	
	REMOTE PORT NO.	10001	65535	1024	
	COMMAND FORMAT @@@@	AQ6370	-	-	
HARD COPY DEVICE @@@@		FILE	-	-	
TRIG INPUT MODE		SMPL TRIG	-	-	
TRIG OUTPUT MODE		OFF	-	-	
AUTO OFFSET OFF/ON		ON	-	-	
UNCAL WARNING DISPLAY OFF/ON		ON	-	-	
BUZZER	CLICK OFF/ON	ON	-	-	
	WARNING OFF/ON	ON	-	-	
LEVEL DISP DIGIT *		2	3	1	
WINDOW TRANSPARENT OFF/ON		ON	-	-	
SET CLOCK	YR-MO-DY	ON	-	-	
	MO-DY-YR	OFF	-	-	
	DY-MO-YR	OFF	-	-	
SELECT COLOR @@@@		COLOR1	-	-	

## 9.3 Help

### Procedure

1. Displays a menu for displaying help.
2. Press **HELP**. An explanation for the displayed menu appears.
3. Select the soft key of the help text to display, then press the **SELECT** soft key. The help information is displayed.
4. To quit, press the **QUIT HELP** soft key.

#### Menu after pressing HELP

KEY	EXPLANATION
SWEEP	Selects the sweep mode.
AUTO	This key automatically sets the optimal measurement conditions for the light source being measured. MORE INFO
REPEAT	Perform repeat sweeping. The soft key is highlighted and repeat sweeping starts.
SINGLE	Perform a single sweep. The soft key is highlighted and a single sweep starts.
STOP	Stop sweeping.
SEGMENT MEASURE	Measure just the number of sampling points set using the <SEGMENT POINT> key, with the current stopped position serving as the sweeping start position.
SEGMENT POINT	Set the number of sampling points for performing <SEGMENT MEASURE>key. Setting Range : 1 to 50001 (Default:1)
SWEEP PNR 501	Set a function which limits the sweeping range during a sweep to the space between line markers. MORE INFO
SWEEP INTERVAL MINIMUM	Set the time from one sweeping start to the next sweeping start during repeat sweeping. MORE INFO

Selection of soft keys for displaying help

Displays the selected help text

## 9.4 Registering and Loading Character Strings

In menus such as File Name that have PRESET WORD soft keys, you can register input character strings and load previously registered strings.

### Procedure

#### Registering Strings

1. After a string has been entered in the string name entry screen, press the **PRESET WORD** soft key.  
The character string registering/loading menu appears.
2. Select a registration number using the UP and DOWN arrow keys.
3. Press the **SAVE** soft key. The character string is registered to the specified number.

#### Loading Character Strings

1. After moving the cursor over the place to enter a string in the string name entry screen, press the **PRESET WORD** soft key.  
The character string registering/loading menu appears.
2. Select the registration number of the string to load using the UP and DOWN arrow keys.
3. Press the **RECALL** soft key. The character string is registered to the specified number.

#### Deleting Character Strings

1. In the string name entry screen, press the **PRESET WORD** soft key.  
The character string registering/loading menu appears.
2. Select the registration number of the string to delete using the UP and DOWN arrow keys.
3. Press the **CLEAR** soft key. The character string is registered to the specified number.

The screenshot shows the 'WRITE : GRAPHICS TO FILE' menu. The 'FILE NAME' is 'INT:\GD013.BMP'. Below is a table of registered strings:

FILE NAME	DATE & TIME	LABEL/PROGRAM NAME
GD013.BMP	2006-03-01 18:11:34	<DIRECTORY>
DIR_1	2006-03-01 20:54:42	<DIRECTORY>
GD000.BMP	2006-03-07 13:04:13	
GD000.TIF	2006-03-01 12:55:20	
GD001.BMP	2006-03-07 13:04:24	
GD001.TIF		
GD002.BP		!@#%&'()*+,-./:;<=>?
GD003.BP		abcdefghijklmnopqrstuvwxyz @!~"{}~() 0123456789
GD004.BP		
GD005.BP		
GD006.BP		
GD007.BP		
GD008.BP		
GD009.BP		
GD010.BP		
GD011.BP		
GD012.BP		

The screen also shows a 'SAVE/RECALL : PRESET WORD' menu with options for PRESET WORD, CLEAR, SAVE, and RECALL. A label 'Character string selection' points to the UP and DOWN arrow keys on the right side of the screen.

**List of registered character strings**

## 9.5 Other Settings

### Procedure

#### UNCAL mark and Warning Display Settings

1. Press **SYSTEM**.
2. Press the **MORE 1/4** soft key two times to display the MORE 3/4 screen.
3. Press the **UNCAL WARNING OFF ON** soft key. The settings turns ON and OFF each time you press the key. When ON, the UNCAL mark and a warning is displayed.

#### Buzzer Settings

1. Press **SYSTEM**.
2. Press the **MORE 1/4** soft key two times to display the MORE 3/4 screen.
3. Press the **BUZZER** soft key. The menu for turning the click sound and warning sound ON/OFF is displayed.
4. Press the **CLICK** or **WARNING** soft key. The settings turn ON and OFF each time you press the selected soft key. When ON, the buzzer sound is enabled.

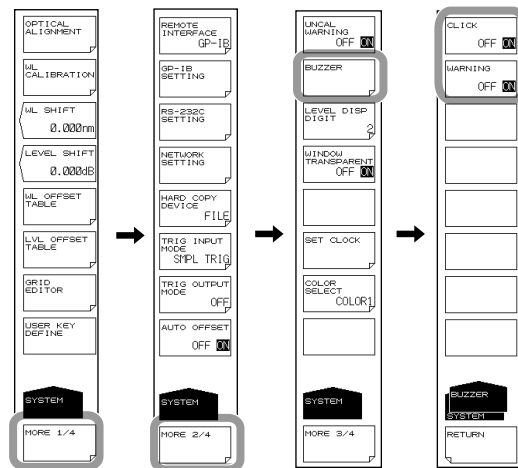

#### Setting the Test Mode

The test mode is adjusted at the factory, and is not typically changed by end users.

1. Press **SYSTEM**.
2. Press the **MORE 1/4** soft key three times to display the MORE 4/4 screen.
3. Press the **TEST MODE** soft key. The password entry screen is displayed.
4. To cancel this screen press another soft key or panel key.

### Setting the Screen Image Data Output Destination

You can specify the output destination used when the COPY key is pressed.

1. Press **SYSTEM**.
2. Press the **MORE 1/4** soft key. The MORE 2/4 screen is displayed.
3. Press the **HARD COPY DEVICE** soft key. The output destination selection menu is displayed.
4. Press the **INTERNAL** soft key to specify the built-in printer as the output destination, or the **FILE** soft key to specify a file.

**Note**

- The INTERNAL key is not available if no built-in printer is installed.
- If you select FILE, files are saved to the current directory, which is set using the FILE key.

### Turning Automatic Offset ON/OFF

You can specify whether to have the instrument perform automatic offset adjustment on its internal amplifier circuit.

1. Press **SYSTEM**.
2. Press the **MORE 1/4** soft key. The MORE 2/4 screen is displayed.
3. Press the **AUTO OFFSET OFF ON** soft key. The settings turns ON and OFF each time you press the key.

**Note**

- If the AUTO OFFSET key is OFF, the offset can fluctuate over time, and the level axis performance can degrade. Always have it turned ON.
- When the AUTO OFFSET key is set to ON,  is displayed at the bottom of the screen.

## Explanation

### Automatic Offset

When the AUTO OFFSET key is set to ON, the offset of the internal amplifier circuit is adjusted at time intervals of approximately 10 minutes. (Default: ON)  
 If the AUTO OFFSET key is OFF, the auto-offset adjustment operation is not performed. When you switch from OFF to ON, the offset adjustment is executed immediately. When switched to ON, the offset adjustment is performed during repeat sweeping when sweeping reaches 100%.  
 During a single sweep, the offset adjustment is performed when the sweep is completed. During offset adjustment, "ZEROING" is displayed in the lower left corner of the screen.

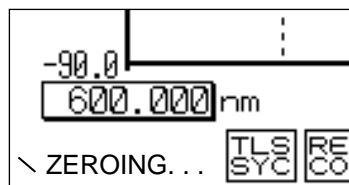

## 10.1 Upgrading the Firmware

### Procedure

#### Preparing for Upgrade

##### Downloading the Firmware

Download the updating software from the Yokogawa Web site.

Save the downloaded software to a USB memory device.

<http://www.yokogawa.co.jp/tm/>

##### Removing the Ethernet Cable

Confirm that the instrument is not connected to a network. The upgrade cannot be performed if connected to a network.

#### Upgrading the Firmware

### CAUTION

During the upgrade, do not manually turn the power OFF. The instrument may not be able to start up again.

1. Press **SYSTEM**. The menu regarding the system appears.
2. Press the **MORE 1/4** soft key to display MORE 4/4.
3. Press the **VERSION** soft key. The software version is displayed.
4. Press the **UPDATE** soft key. The message, "Insert Update Files" is displayed.
5. Insert the USB memory device containing the updating software into the instrument.
6. Press the **CONTINUE** soft key. A list of updating software is displayed.
7. The message, "Please remove USB storage device" is displayed. Remove the USB memory.

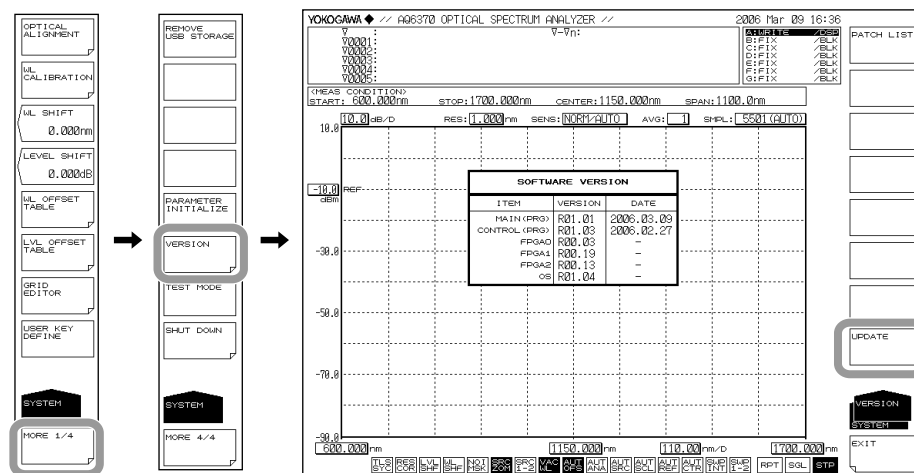

## 10.1 Upgrading the Firmware

---

8. Press the **YES (REBOOT)** soft key.

Step 1 of the version upgrade begins. When step 1 of the upgrade is finished, the instrument restarts automatically.

When the instrument restarts, step 2 of the upgrade begins at the same time.

When step 2 of the upgrade is finished, the power turns OFF automatically.

This concludes the version upgrade.

If you press the NO soft key, the upgrade is cancelled and the instrument returns to the previous screen.

### **Note**

---

The instrument can not be upgraded when connected to a network.

If connected to a network, the message, "Please disconnect LAN CABLE from LAN cable and remove USB storage device" appears and the YES soft key is disabled. If you remove the cable from the Ethernet connector, the message, "Please remove USB storage device" appears and the YES soft key is enabled.

---

### **Displaying the Patch List**

4. Continuing on from step 3, press the **PATCH LIST** soft key.

A list of patches installed up to the present is displayed.

### **Explanation**

When the version is upgraded, settings entered prior to the upgrade are initialized. If necessary, save your settings.

---

## 10.2 Mechanical Inspection

---

### WARNING

When performing inspection, turn OFF the MAIN POWER switch on the rear panel and remove the power cable.

---

---

### CAUTION

- If any foreign particles become trapped in the various connectors, malfunction or damage can result.
  - If any of the various types of connectors do not fit snugly, the instrument may not operate normally.
  - If any abnormalities occur, please contact your nearest Yokogawa representative.
- 

Check the following:

- That the instrument's exterior is not damaged or deformed.
- That all switches, connectors, and other assembled parts are not loose.
- That switches can be operated smoothly.

---

## 10.3 Operational Inspection

### Checking the Operations of Each Switch

With the power to the instrument turned ON, operate each switch once briefly to check that the unit functions properly.

### Checking the Operations of the Built-In Thermal Printer (Optional)

1. Open the cover of the printer inside the unit. Check that the printer paper has been placed properly. For instructions on installing the printer paper, see section 4.6, "Printing from the Built-In Printer."
2. When the window shows waveforms, press the **FEED** switch and check that paper is being fed into the printer.
3. Press the **COPY** switch and check that the indications on the window are printed properly.

## 10.4 Inspection of Wavelength Accuracy

Perform a check of the instrument's wavelength accuracy.  
Use a light source such as a gas laser whose wavelength accuracy is known.

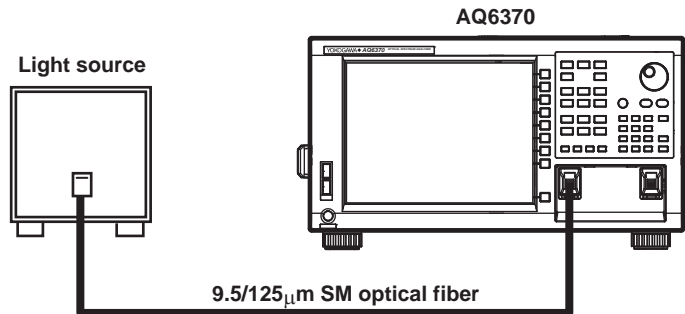

### Procedure

1. Connect a light source to the instrument as shown in the figure above, then measure spectrums of the light source.  
Confirm that the THRESH 3 dB center wavelength of the measured spectrum matches the wavelength of the light source (is within the wavelength accuracy standard).  
For more information, see section 7.1, "Spectrum Width Measurement" and chapter 11, "Specifications."
2. If the wavelength error is large, use the internal reference light source to calibrate wavelengths.  
For the calibration procedure, see section 3.7, "Wavelength Calibration."
3. For performing wavelength calibration, check wavelength accuracy again according to procedure.

### Note

If the wavelength error of the instrument is outside of  $[+/-] 0.5$  nm, you cannot perform wavelength calibration with the internal reference light source. In this case, readjustment is necessary. Please contact your nearest Yokogawa representative.

## 10.5 Inspection of Level Accuracy

Perform a check of the instrument's level accuracy.  
Use a light source of 1310 nm or 1550 nm.

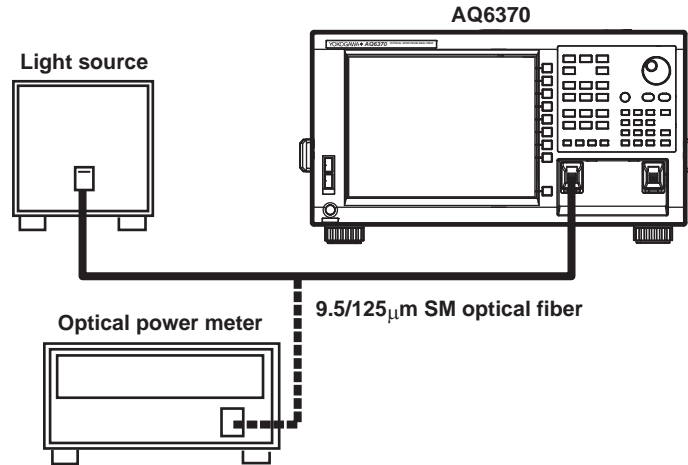

### Procedure

1. Execute the alignment adjustment function on the unit's internal monochromator. For details, see section 3.6, "Alignment Adjustment."
2. Connect the light source and instrument with a 9.5/125 [MICRO]m SM optical fiber and turn the light source ON.
3. Press **SWEEP**.
4. Press the **AUTO** soft key. The spectrum of the light source is automatically measured.
5. When automatic measurement is complete and REPEAT sweep begins, press **SETUP**.
6. Press the **RESOLUTION** soft key then set the instrument's wavelength resolution to 1.000 nm.
7. Press **PEAK SEARCH** or **MARKER** then measure the peak level of the waveform.
8. Remove the SM optical fiber from the instrument and connect the light source to an optical power meter.
9. Use the optical power meter to measure power values of the light source.
10. Check that peak level values obtained in step 7 agree with the ones obtained by the optical power meter (within the specified level accuracy). For information on level accuracy, see chapter 11, "Specifications."

### Note

- Connect the light source with the unit via the 9.5/125 mm SM optical fiber. Then, turn on the light source. If a wide spectrum light source is used, the power measurements may not be accurate.
- The level measurement error of the instrument changes as shown in the figure below, according to the numerical aperture (NA) of the optical fiber connected to the input connector. The instrument's absolute level is calibrated using a 9.5/125 μm single-mode optical fiber (SSMA type in JIS C6835, with PC polishing, 9.5 μm mode field diameter, and 0.104 to 0.107 NA). Even if a single-mode optical fiber is used, the level accuracy will be outside the specifications if the NA is not in the range shown above.

## 10.6 Replacing Fuses

Fuses come standard and are already installed in the instrument upon receipt. If you need to replace a fuse due to an equipment failure, first determine the cause of the failure and solve the problem before replacing the fuse. The AQ6370 uses ordinary fusing-type 5-amp fuses with a 100–120 V power supply, and use time lag-type 3.15-amp fuses with a 200–240 V power supply.



### WARNING

- When replacing fuses, turn OFF the POWER switch on the rear panel and remove the power cord. Replacing a fuse while the power is on may result in injury due to electric shock.
- After replacing a fuse, perform the protective grounding procedures before turning the power back on. Turning the power on without a protective ground may result in injury due to electric shock.
- Make sure the AC supply voltage is at the proper level before turning the MAIN POWER switch on. If the AC supply voltage is not at the proper level, turning the power switch on may damage the inside of the instrument.

### Procedure

1. Pull the AC power supply fuse holder on the rear panel of the instrument toward you. When you pull the holder out far enough to see the fuse, you can pull it down.

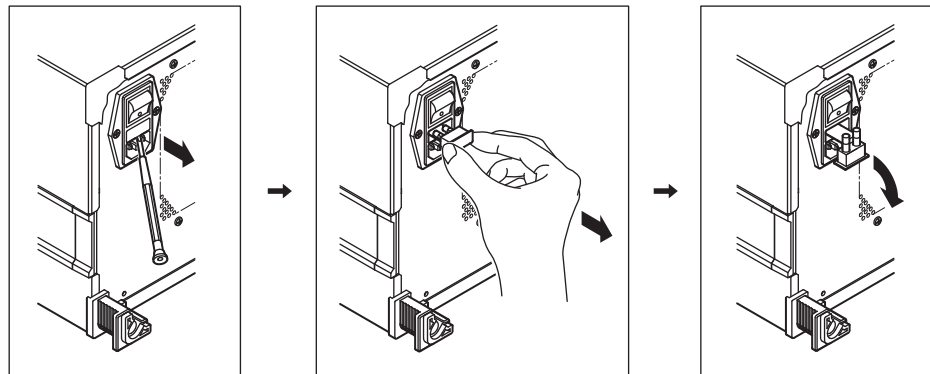

2. Replace the old fuse with a new one.
3. Push the fuse holder back in until flush with the AC power connector face. If the fuse holder is not pushed in sufficiently, electrical contact may not be made completely or at all, which can cause heating or tripping of the fuse.

### Note

Be careful not to pull on the fuse holder with excessive force.

---

## 10.7 Daily Maintenance

### Cleaning the Exterior of the Instrument

When removing dirt from the case or operation panel, remove the power cord from the power outlet, then wipe gently with a clean, dry cloth. Do not use volatile chemicals since this might cause discoloring and deformation.

### Cleaning the Optical Output Section of the Internal Reference Light Source

#### Cleaning the Optical Connector Connection Section of the Connector Adapter

It is recommended that the following cleaner be used for this procedure.

Recommended cleaner: "Cletop Stick Type" (NTT-ME)

Open the optical connector cover at the front of the unit. Use the cleaner to clean the optical connector connection section. Grasp it as close to the cleaner support (base) as possible. Insert the cleaner straight into the optical connector connection section and rotate it.

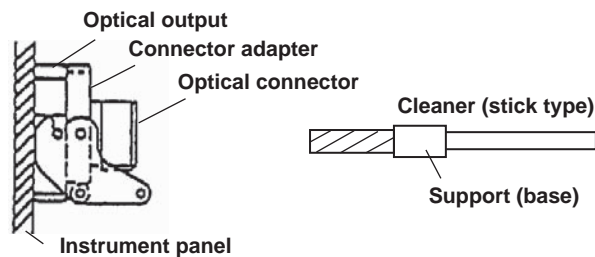

---

### CAUTION

Wiping with a soiled cleaner can damage the optical outputs.

---

### Cleaning the Optical Output

Remove the connector adapter, then use a swab dipped into a small quantity of undiluted alcohol to clean the ferrule end of the optical output section. Be sure to use a new swab each time.

Remove the connector adapter from the unit. For removal, refer to section 3.2, "Attaching the Connector Adapter." Use a swab dipped into a small quantity of undiluted alcohol to clean the ferrule end of the optical output section.

After the cleaning is finished, connect the connector adapter to the instrument.

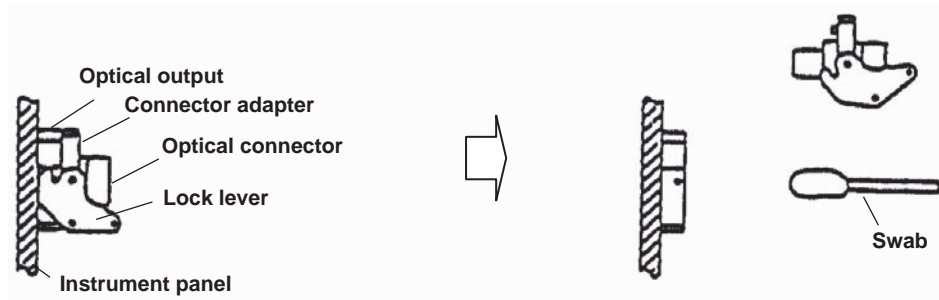

### CAUTION

- When attaching or removing a connector adapter, be careful not to damage the ferrule edge or adapter.
- Wiping with a soiled swab can damage the optical outputs.

---

## 10.8 Care during Storage

If the instrument is stored for a long time, sufficient care should be taken of the following:

- Wipe off any dust, fingerprints, or other dirt that has adhered to the instrument.
- Perform the inspections given in section 10.2, "Operational Inspection" to check that the instrument operates properly.
- Do not store the unit in the following locations:
  - Where it would be exposed to direct sunlight or excessive dust
  - Where water droplets can contact the instrument, or where high humidity can cause them to form on the instrument
  - Where active gas is present, or where the instrument may be subject to corrosion
  - Where the humidity indicated below can occur
  - Where temperatures can exceed 50 [DEGC]
  - Where the temperature can fall below -10 [DEGC]
  - Where the humidity can exceed 80%

For extended storage, it is recommended that the instrument be stored within the range of the following environmental conditions while, at the same time, the above conditions are met.

- Temperature 5–30[DEGC]
- Humidity 40-70%
- Daily fluctuations of temperature/humidity are small.

## 10.9 Recommended Replacement Parts

Yokogawa warrants the instrument based on the period and stipulations described on the warranty sheet.

As stated in the warranty, the following parts (parts with limited lifespan) are not included in the warranty. For replacement of parts, please contact your nearest Yokogawa representative.

<b>Part Name</b>	<b>Lifespan</b>
Built-in printer (optional)	At normal operating conditions, equivalent of 360 rolls of printer roll paper (part no. B9988AE)
LCD backlight	At normal operating conditions, approximately 25000 hours

The following parts are wearable. It is recommended to replace them after the time period indicated below. For replacement of parts, please contact your nearest Yokogawa representative.

<b>Part Name</b>	<b>Replacement Period</b>
Cooling fan	3 years
Backup battery (lithium)	5 years

## 10.10 Warning Display Function

No.	Message	Cause of Warning
<b>No.1 - 49: Message generation after the execution of functions</b>		
1	Unsuitable Resolution	Data may not be extracted completely, because the resolution setting is not appropriate for the span and the sampling number.
2	Unsuitable Level Scale	A level scale larger than 5 dB/DIV has been set in the range fixed mode (SENS:NORM HOLD).If a level scale is set to 5 dB/DIV or more in the range fixed mode, data from the top and bottom of the screen may not be properly displayed.
3	Unsuitable Ref Level	Although an attempt was made to set the peak level of a waveform to the reference level, the nearest value within the range was chosen because the peak level value was outside the setting range of the reference level values.
4	Unsuitable Marker Value	Although an attempt was made to set a maker value to the reference level, the nearest value within the range was chosen because the marker value was outside the setting range of the reference level values.
5	<AUTO ANALYSIS> off	Selection of the <AUTO ANALYSIS> key was canceled.
6	<AUTO SEARCH> off	Selection of the <AUTO SEARCH> key was canceled.
7	Each Trace resolution mismatch	When the calculation between traces was performed, resolutions of traces were set differently.
8	<HOLD> off	HOLD was canceled because the allocation of traces to the divided screen was changed.
9	Trace * state changed	The HOLD state was canceled because the state of traces under HOLD was changed from FIX to another state.
10	<AUTO REF LEVEL> off	Selection of the <AUTO REF LEVEL> key was canceled.
11	<AUTO SUB SCALE> off	Selection of the <AUTO SUB SCALE> key was canceled.
12	Input light power is too high	Since the intensity of input light is too high, measuring waveforms may be saturated.
<b>No.50 - 199: Generation of a reason why a function cannot be executed</b>		
50	TLS does not respond	The tunable laser source does not respond.
51	TLS is not connected	The tunable laser source is not connected.
52	Unsuitable TLS mode	The tunable laser source is set incorrectly.
53	Unsuitable wavelength range	The wavelength range exceeds the settable range of the tunable laser source.
101	All traces in have been set to FIX.	FIXed state Waveforms cannot be re-written, because all traces
102	Sweep stopped	Sweep was stopped, because all traces were set to FIX during the sweep.
103	No data in active trace	An attempt was made to execute analysis functions when there was no data in an active trace.
107	Unsuitable memory number	A number other than 0 - 99 was specified when the memory was saved or recalled. Or, an attempt was made to recall data from a memory where waveforms have not been saved.
108	Marker setting out of range	An attempt was made to execute the analysis function between markers in the state where both line marker 1 and line marker 2 were set outside the measurement range.
109	Auto sweep failed	Although the AUTO sweep started, the sweep stopped because optimum conditions were not found.
110	No data between line markers	An attempt was made to execute the analysis function in a state where there was no data in the line markers of an active trace.
111	<G=MKR FIT> failed	Trace G cannot write fitting curve because numbers of data is not sufficient during <G=MKR FIT>.
120	USB Storage not inserted	USB storage medium not inserted.
121	USB Storage not initialized	SUB storage not initialized.

No.	Message	Cause of Warning
122	USB Storage is write protected	The USB storage device is write protected.
123	File not found	The specified file cannot be read because it has not been found. Or, the file does not exist on the disk.
124	Illegal directory name	Directory cannot be created because the name is not valid.
125	Illegal file name	A file cannot be saved due to an incorrect file name.
126	Directory already exists	Directory cannot be created because a directory of the same name already exists.
128	File is write protected	The file cannot be re-written or deleted because its property has been set to READ ONLY.
129	USB Storage full	The file cannot be saved, because the hard disk or the USB storage device is full.
130	Directory full	No files can be created because the directory area is full.
131	No data	There was no data to be saved, although an attempt was made to save the file.
132	File is not a trace file	The file cannot be read because it is not a waveform file.
133	File is not a program file	The file cannot be read because it is not a program file.
134	File is not a data file	The file cannot be read because it is not a data file.
135	File is not a settings file	The file cannot be read because it is not a settings file.
137	File is not a template file	File cannot be loaded since it is not a template file or there is a problem with the format of the template data.
138	Cannot copy	The file copy cannot be executed because the "copy from" file and the "copy to" file have the same name.
140	No paste possible	The paste operation cannot be executed during the editing of programs because the number of blank rows is not sufficient.
141	No merge possible	It is not possible to execute a merge during the editing of programs because the merged result would exceed the maximum number of rows.
142	WL calibration failed	Calibration cannot be executed because the level of a light source is not sufficient during the wavelength calibration or because wavelength deviations exceed the calibration range.
143	Optical Alignment failed	Alignment adjustment cannot be executed because the level of a light source is not sufficient during the alignment adjustment.
144	Go/No go judgment stopped	Go/No go judgment stopped because template data reading or AUTO sweep was carried out with Go/No go judgment function set to ON.
145	No template data	Go/No go judgment or template data display was attempted to be made with no template data provided.
160	Printer paper empty	There was no printer paper, although an attempt was made to use the internal printer for printing.
161	Printer head up	It was not possible to execute printing because the head-up lever of the internal printer was raised.
164	Printer Head Temperature error	The temperature of the built-in printer's printer head is abnormal when printing.
170	Illegal character	An illegal character was entered for a network name.
171	Illegal address	An illegal address was set to an IP address.
<b>No. 200 - 299: Warnings for hardware failures</b>		
200	Fan motor stopped!	The fan motor (main unit) stopped. Automatically shuts down after 10 seconds from occurrence.
201	Calibration data failed!	Started up in emulation mode because there was a problem with the instrument's calibration data.
202	Fan motor stopped!	The fan motor (CPU) stopped. Automatically shuts down after 10 seconds from occurrence.
205	Internal communication error!	An abnormality occurred during instrument-internal communication.
206	Internal communication error!	An abnormality occurred during instrument-internal communication.
207	Internal Temperature Over!	Internal temperature is abnormally high. Automatically shuts down after 10 seconds from occurrence.
210	Internal Temperature warning!	Warning for rising internal temperature.

## 10.10 Warning Display Function

No.	Message	Cause of Warning
211	Auto offset error!	Obtained an abnormal value during AUTO OFFSET operation.
212	Auto offset error!	Obtained an abnormal value during AUTO OFFSET operation.
213	Auto temperature control error!	Problem with the light detector temperature control.
214	Measurement sequence error!	The sweep stopped because measurement sequence fell into disorder during the sweep.
220	Boot sequence error!	Started up in emulation mode because an abnormality occurred upon start-up
221	Boot sequence error!	Started up in emulation mode because an abnormality occurred upon start-up
222	Emulation Mode.	Entered emulation mode because an abnormality occurred.
230	Monochromator error!	Entered emulation mode because an abnormality with the operation of the monochromator occurred.
231	Monochromator error!	Entered emulation mode because an abnormality with the operation of the monochromator occurred.
232	Monochromator error!	Entered emulation mode because an abnormality with the operation of the monochromator occurred.
233	Monochromator error!	Entered emulation mode because an abnormality with the operation of the monochromator occurred.
231	Monochromator error!	Entered emulation mode because an abnormality with the operation of the monochromator occurred.
<b>No.300 - 399: Errors during the execution of program functions</b>		
300	Parameter out of range	A variable value is out of range or is not defined for a command that sets a parameter using variables.
302	Scale unit mismatch	There is a difference between the Y-axis scale of the active trace and the unit of a parameter in the "LINE MKR 3 or 4" command.
303	No data in Active trace	Setting of the moving marker, a peak (or bottom) search, or activation of the analysis function was made with no data in the active trace.
304	Marker value out of range	Specified wavelength was out of the sweep range in the moving marker or line wavelength marker setting command.
305	No data in trace A or B	No waveform data in traces A or B when executing the "EDFA NF" command
306	Invalid data	Trace had no data when attempting to save it to memory or to write it to FD/HDD.
307	Unsuitable Write item	All data items were OFF at execution of "WRITE DATA".
320	Undefined variable	A command containing an undefined variable was executed.
321	Variable unit mismatch	The unit of each variable does not agree within a command containing two or more variables.
322	Overflow	An overflow occurred in an arithmetic operation.
323	Undefined marker variable	A command containing a marker-value variable was executed when no marker had been displayed.
324	Invalid marker variable	A command containing the corresponding variable was executed at a time other than immediately after execution of a spectrum width search, peak search, etc.
325	Undefined line number	GOTO command's jumping destination is a number other than 1 to 200.
326	F1 greater than F2	$F1 > F2$ when the "IF $F1 \leq @@@@ \leq F2$ " command was executed.
340	Printer paper empty	No printer paper
341	Printer head up	No print is made because the printer's head-up lever is raised.
345	Option does not respond	No response from an external device.
346	Option is not connected	No external device is connected.
347	GPIB2 not system controller	System controller connected to the GP-IB2 port has been set to an external computer.
360	Disk full	No file can be created due to insufficient free space on the USB storage medium.
361	USB Storage not inserted	USB storage medium not inserted.
362	USB Storage is write protected	The USB storage device is write protected.

## 10.10 Warning Display Function

No.	Message	Cause of Warning
363	USB Storage not initialized	USB storage not initialized. Or, it has been formatted in a format not supported by this instrument.
364	Directory full	Directory is full, therefore no file can be created.
365	File not found	The specified file cannot be read because it has not been found. Or, the file does not exist on the disk.
366	File is write protected deleted.	The file is specified to be read only, so that it cannot be rewritten or deleted.
367	No data	No data to store.
368	File is not a trace file	A file cannot be read because it is not a trace file.
369	Illegal file name	A file cannot be saved due to an incorrect file name.
380	Undefined program	An attempt was made to run a program that is not defined.
381	Syntax error	Command incorrect (a program has been rewritten for some reason).

# 11.1 Specifications

Item	Specifications
Applicable fiber	SM (9.5/125 $\mu\text{m}$ ), GI (50/125 $\mu\text{m}$ , 62.5/125 $\mu\text{m}$ )
Measurement wavelength range <sup>1</sup>	600 to 1700 nm
Span <sup>1</sup>	0.5 nm to 1100 nm (entire wavelength range), 0 nm
Wavelength accuracy <sup>1, 2, 3</sup>	$\pm 0.02$ nm (1520 to 1580 nm) $\pm 0.04$ nm (1450 to 1520 nm, 1580 to 1620 nm) $\pm 0.1$ nm (full wavelength range)
Wavelength linearity <sup>1, 2, 3</sup>	$\pm 0.01$ nm (1520 to 1580 nm) $\pm 0.02$ nm (1450 to 1520 nm, 1580 to 1620 nm)
Wavelength repeatability <sup>1, 2</sup>	$\pm 0.005$ nm (1 minute)
Measurement data point (Wavelength sampling points)	101 to 50001, AUTO
Wavelength resolution setting <sup>1, 2</sup>	0.02, 0.05, 0.1, 0.2, 0.5, 1.0, 2.0 nm
Resolution accuracy <sup>1, 2, 3</sup>	$\pm 5\%$ (1450 to 1620 nm, resolution setting: 01 to 2.0 nm, resolution correction: ON, wavelength sample setting: AUTO)
Level sensitivity setting	NORM_HOLD, NORM_AUTO, NORMAL, MID, HIGH1, HIGH2 and HIGH3
High dynamic range mode	SWITCH (Sensitivity: MID, HIGH1, HIGH2, HIGH3) CHOP (Sensitivity: HIGH1, HIGH2, HIGH3)
Level sensitivity <sup>2, 4, 5, 7</sup>	-90 dBm (1300 to 1620 nm, resolution: 0.05 nm or more, measuring sensitivity: HIGH3) -80 dBm (1000 to 1300 nm, resolution: 0.05 nm or more, measurement sensitivity: HIGH3) -60 dBm (600 to 1000 nm, resolution: 0.05 nm or more, measurement sensitivity: HIGH3)
Level accuracy <sup>2, 4, 5, 6</sup>	$\pm 0.4$ dB (1310/1550 nm, input level: -20 dBm, measuring sensitivity: MID, HIGH1, HIGH2, HIGH3)
Level linearity <sup>2, 4</sup>	$\pm 0.05$ dB (input level: -50 to +10 dBm, measuring sensitivity: HIGH1, HIGH2, HIGH3)
Level flatness <sup>2, 4, 6</sup>	$\pm 0.1$ dB (1520 to 1580 nm) $\pm 0.2$ dB (1450 to 1520 nm, 1580 to 1620 nm)
Maximum input power <sup>2, 4</sup>	+20 dBm (per channel, full span)
Safe max. input power <sup>2, 4</sup>	+25 dBm (total light input power)
Close-in dynamic range <sup>1, 2, 9</sup>	45 dB (1523 nm, $\pm 0.2$ nm of peak wavelength, resolution: 0.05 nm) 62 dB (1523 nm, $\pm 0.4$ nm of peak wavelength resolution: 0.05 nm) 40 dB (1523 nm, $\pm 0.2$ nm of peak wavelength, resolution: 0.1 nm) 57 dB (1523 nm, $\pm 0.4$ nm of peak wavelength, resolution: 0.1 nm)
Polarization dependency <sup>2, 4, 6</sup>	$\pm 0.05$ dB (1550/1600 nm) $\pm 0.08$ dB (1310 nm)
Sweep time <sup>1, 7, 8</sup>	0.5 s (NORM_AUTO), 1 s (NORMAL) 2 s (MID) 5 s (HIGH1), 20 s (HIGH2), 75 s (HIGH3)
Function	
Automatic measurement	Program function (64 programs, 200 steps)
Setting of measuring conditions	Center wavelength, span, wavelength sampling points, wavelength resolution, measurement sensitivity, high dynamic mode, averaging times (1 to 999), sweep (single, repeat, AUTO: automatically sets measuring conditions), sweep between marker function, pulse light measurement function, external trigger measurement function, sweep status output function, analog output function, synchronous sweep with turnable laser source function, air/vacuum wavelength measurement function, template-based Pass/Fail judgment function
Display	Level scale (0.1 to 10 dB/div., linear scale), level subscale (0.1 to 10 dB/div., linear scale), reference level display, vertical axis DIV display (8, 10, 12), horizontal axis wavelength/frequency display, horizontal axis scale zoom in/out display, measuring conditions display, noise mask display, data table display, label display, split screen display, percent display, power density (dB/nm) display, dB/km display, template display
Traces	Simultaneous display of 7 independent traces, write mode fixed mode setting, show/hide setting, max/min value detection display, calculation between traces display, roll averaging display (sweep average) (2 to 100 times), normalized display, curve fit display (peak curve fit, marker curve fit), trace copy function, trace clear function

## 11.1 Specifications

Item	Specifications	
Function		
Marker/Search	Delta markers (1024 points maximum), vertical/horizontal line markers, peak search, 2nd peak search, bottom search, 2nd bottom search, auto search (ON/OFF), search between vertical axis line markers, search within zoom area	
Analysis	Spectral width analysis (threshold, envelope, RMS, Peak RMS, notch), WDM (OSNR) analysis, EDFA-NF analysis, filter peak/bottom analysis, WDM filter peak/bottom analysis, DFB-LD analysis, FP-LD analysis, LED analysis, SMSR analysis, power analysis, PMD analysis, Pass/Fail judgment from template, auto analysis, analysis between vertical axis line markers, analysis within the zoom area	
Other	Auto alignment function with built-in reference light source and automatic wavelength calibration function	
Data storage		
Internal memory	64 traces, 64 programs, 3 templates	
Internal storage	128 MB max	
External storage	USB storage media (USB memory/HDD), format: FAT32	
File types	CSV (text), binary, bitmap, TIFF	
Interfaces		
Remote control	GP-IB, RS-232, Ethernet (TCP/IP) AQ6317 series compliant commands (IEEE488.1) and IEEE488.2	
Categories	GP-IB x 2 (for standard and external control), RS-232, Ethernet, USB1.1 x 2, PS/2 (for keyboard), SVGA output, analog output port, trigger input port, trigger output port	
Optical connectors	For optional I/O, AQ9447(*) connector adapter (option) required. For wavelength reference light source output, AQ9441(*) universal adapter (optional) required. (*): Connector types: FC, SC, ST	
Printer	Built-in thermal printer (factory option)	
Display <sup>11</sup>	10.4" color LCD (resolution: 800 x 600 pixels)	
Power requirement	100 to 240 VAC, 50/60 Hz, approximately 150 VA	
Environment conditions	Operating temperature range: +5 to +35°C Operating humidity range: -10 to +50°C Ambient humidity: 80% RH or less (no condensation)	
Recommended calibration period	1 year	
External dimensions <sup>10</sup>	Approximately 426 (W) x 221 (H) x 459 (D) mm	
Mass	Approximately 27 kg (excluding built-in printer)	
Safety standards	Conforming standards	EN61010-1 EN60825-1
	Pollution degree 2 <sup>12</sup>	
Emissions	Conforming standards	EN61326 Class A EN61000-3-2 EN61000-3-3 This is a class A instrument (industrial use). Wireless interference may occur in home environments. If so, the user must take appropriate countermeasures.
	Cable conditions	<ul style="list-style-type: none"> <li>• TRIGGER IN, TRIGGER OUT, ANALOG OUT terminal. Use a BNC cable<sup>13</sup></li> <li>• Use a serial (RS-232) interface connector and RS-232 shielded cable.<sup>13</sup></li> <li>• Use an Ethernet connector and a category 5 or higher Ethernet cable.<sup>14</sup></li> <li>• Use a VIDEO OUT connector and a D-sub 15pin VGA shielded cable<sup>13</sup></li> <li>• Use a USB peripheral (such as a mouse) that uses a USB port and shielded cable<sup>13</sup></li> <li>• Use a keyboard connector and PS/2 shielded cable<sup>13</sup></li> <li>• Use the GP-IB1 or GP-IB2 interface connector and a GP-IB shielded cable<sup>13</sup></li> </ul>

Item	Specifications
Immunity	Conforming standards EN61326 Annex A <sup>15</sup>
	Effect in immunity environment Wavelength measurement sensitivity: Within $\pm 0.1$ nm
	Cable conditions Same as above emission cable conditions.

- 1: Horizontal axis scale: In wavelength display mode
- 2: 10/125  $\mu\text{m}$  single mode fiber, after warm-up of 2 hours, built-in wavelength reference light source  
After alignment adjustment, at ambient temperature of  $23 \pm 5^\circ\text{C}$
- 3: After wavelength calibration with built-in wavelength reference light source
- 4: Vertical scale: absolute value level display mode, resolution setting: 0.05 nm or more, resolution correction: OFF
- 5: When using 10/125  $\mu\text{m}$  single mode fiber (SSMA type in JIS C6835, PC polishing, mode field diameter: 9.5  $\mu\text{m}$ , NA: 0.104 to 0.107)
- 6: At ambient temperature of  $23 \pm 3^\circ\text{C}$
- 7: High dynamic mode: OFF, pulse light measurement mode: OFF, turnable laser source synchronous sweep mode: OFF, resolution correction: OFF
- 8: Span 100 nm or less, wavelength sampling points: 1001, averaging times: 1
- 9: High dynamic mode: CHOP or SWITCH, resolution correction: OFF
- 10: Note that this excludes the protector and handle
- 11: The LDC display may contain defective pixels (always ON or always OFF).  
(0.002% or fewer of all pixels including RGB). Does not indicate a general malfunction.
- 12: Pollution degree refers to the degree of adherence by a solid, liquid, or vapor that reduces the withstand voltage or surface resistance factor. Pollution degree 1 applies to closed atmospheres (no pollution, or only dry, non-conductive pollution).  
Pollution degree 2 applies to normal indoor atmospheres (with only non-conductive pollution).
- 13: Use a cable of 3 m in length or less.
- 14: Use a cable of 30 m in length or less.
- 15: Annex A: Provides for immunity testing for equipment intended for use in industrial environments.

## 11.2 External Dimensions

Unit : mm  
(approx. inch)

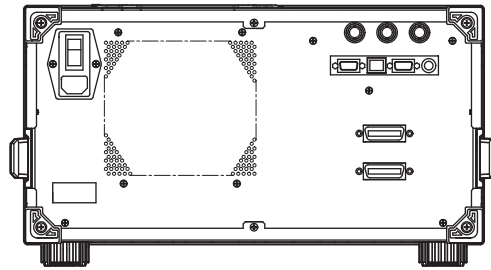
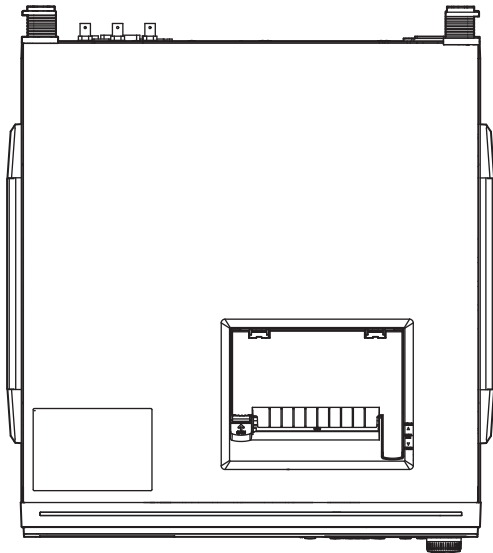

**REAR VIEW**

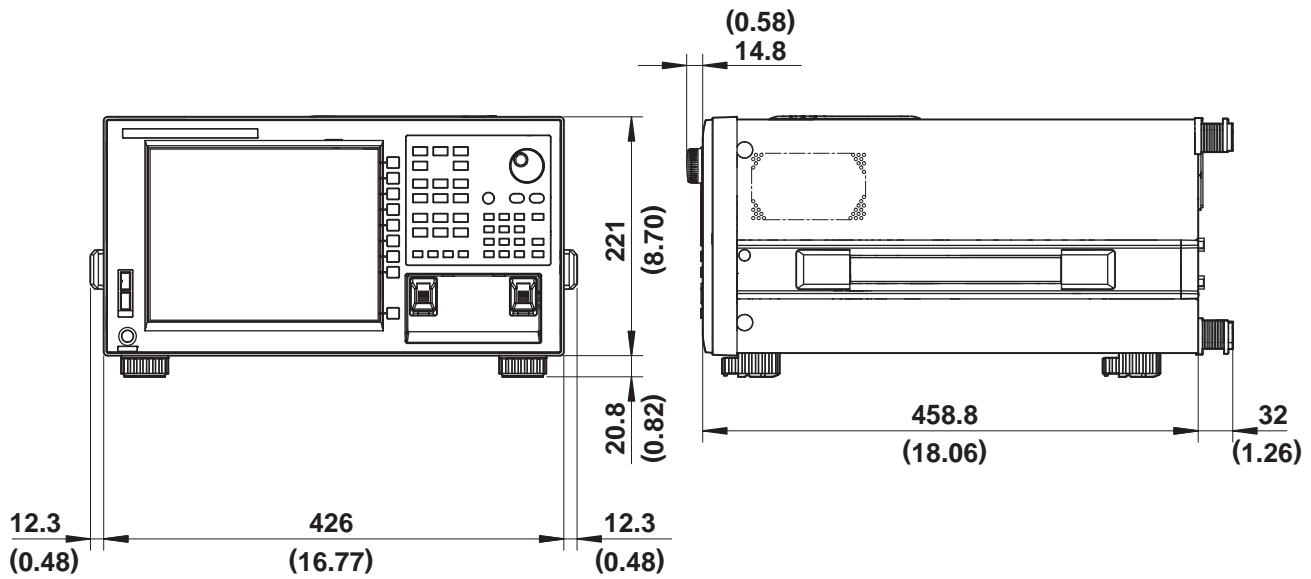

If not specified, the tolerance is  $\pm 3\%$ . However, in cases of less than 10 mm, the tolerance is  $\pm 0.3$  mm.

## Appendix 1 GRID Table for WDM Wevelength

Some analytical functions refer to the GRID table for analysis(See the following table.) The AQ6370 contains the nominal center frequencies specified by the ITU-T (International Telecommunication Union-Telecommunication sector) G692 as the GRID table. It also contains two tables: the standard GRID table created according to the pre-defined wavelength (frequency) range and the custom GRID table that users can edit freely.

### List of Analytical Functions with GRID Tables

Function	Item	Parameter Name	Setting Parameter
WDM	DISPLAY SETTING	DISPLAY TYPE	DRIFT(GRID)
FILTER PEAK	CROSS TALK	ALGO	GRID
FILTER BOTTOM	CROSS TALK	ALGO	GRID
WDM FILTER PEAK	CAHNEL DETECTION/ NOMINAL WAVELENGTH	ALGO	GRIF FIT GRID
WDM FILTER BOTTOM	CAHNEL DETECTION/ NOMINAL WAVELENGTH	ALGO	GRIF FIT GRID

### Note

Concerning the units of wavelength axis for GRID tables, wavelength values and frequency values can be changed by the setting of marker units.

The two GRID tables (standard and custom) have different parameter ranges, which are shown in the following table.

Type	Parameter Range
Standard GRID Table	
Start frequency	192.1000 THz(fixed)
Stop frequency	196.1000 THz(fixed)
Reference frequency	176.3486~299.7924 THz
Frequency spacing	To be selected from among 200 GHz/100 GHz/50 GHz/25 GHz/12.5GHz
Fixed GRID Table	
Start frequency	176.3486~229.7924 THz
Stop frequency	176.3486~299.7924 THz
Reference frequency	176.3486~299.7924 THz
Frequency spacing	0.1~999.9 GHz

### Standard GRID Table

This GRID table is created with pre-defined wavelength (frequency) ranges. It can be created in the following manner by setting the reference wavelength (frequency) and frequency spacing.

### Custom GRID Table

Users can edit this GRID table freely. It is created automatically by setting the start/stop wavelength (frequency), reference wavelength (frequency), and frequency spacing. Users can add or delete an arbitrary channel to/from the created GRID table or edit wavelength (frequency) values for each channel there.

## Appendix 2 Data Calculation Algorithms for Spectrum Widths

The AQ6370 can calculate spectrum widths of waveforms being displayed. This section provides four types of spectrum width calculation methods as well as algorithms for the NOTCH width calculation.

### THRESH Method

This method is used to obtain the spectrum widths of two points, which are lower than the peak level by a threshold value (THRESH [dB]) specified by a parameter, as well as their center wavelengths.

The following table shows the details of parameters for the THRESH method.

Parameter	Abbreviation	Default Value	Setting Range	Unit	Description
THRESH	TH	3.00	0.01 to 50.00	dB	Threshold value
THRESH K	K	1.00	1.00 to 10.00	-	Multiplying factor
MODE FIT	MODE FIT	OFF	ON / OFF	-	Set whether the half of maximum point is aligned to the mode peak or not.

Algorithms differ depending on the number of mode peaks. Algorithms for these numbers are described below.

#### In the case of one mode peak

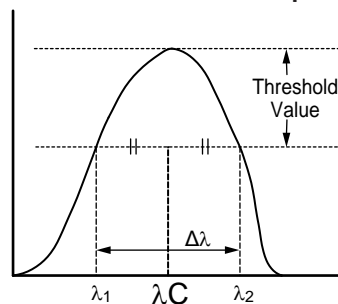

- Perform a mode search to obtain the mode peak.
- Set the wavelengths, which cross the line below the mode peak by the threshold value (THRESH[dB]), to  $\lambda_1$  and  $\lambda_2$ .
- Use the following equations, which incorporate multiplication by the multiplying factor K for  $\lambda_1$  and  $\lambda_2$ , to obtain new  $\lambda_1$  and  $\lambda_2$ .

$$\lambda'c = (\lambda_2 + \lambda_1) / 2$$

$$\lambda_1 = K \times (\lambda_1 - \lambda'c) + \lambda'c$$

$$\lambda_2 = K \times (\lambda_2 - \lambda'c) + \lambda'c$$

- Obtain the spectrum width from the following equation.
- Obtain the center wavelength  $\lambda'c$  from the following equation.

$$\Delta\lambda = \lambda_2 - \lambda_1$$

$$\lambda'c = (\lambda_2 + \lambda_1) / 2$$

#### Note

If "MODE FIT" is set to ON in the case of a one mode peak, the spectrum width  $\Delta\lambda$  and the center wavelength  $\lambda'c$  will become as follows.

$$\Delta\lambda = 0.0000\text{nm}$$

$$\lambda'c = \text{center wavelength of the mode peak}$$

In the case of two or more mode peaks

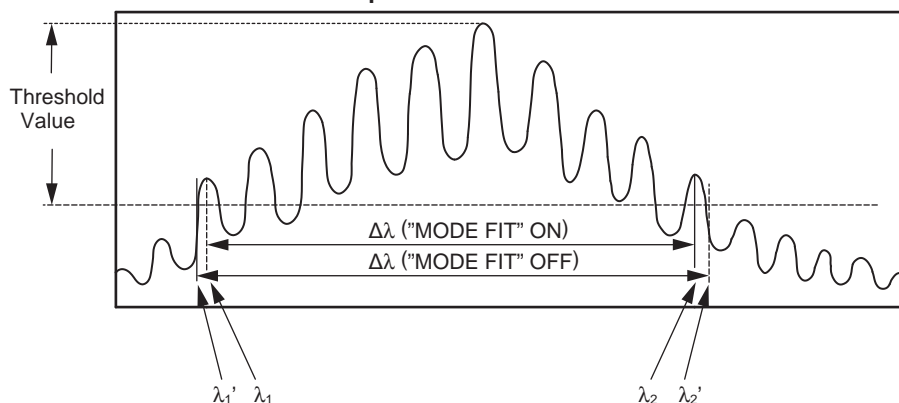

- If “MODE FIT” is ON, set the wavelengths of the mode peaks, which are outmost from the threshold value (THRESH[dB]) among the mode peaks, to  $\lambda_1$  and  $\lambda_2$ . If “MODE FIT” is OFF, set the wavelengths, which are located outside  $\lambda_1$  and  $\lambda_2$ , and which cross the line below the mode peak with the largest mode peak level by the threshold value (THRESH[dB]), to  $\lambda'_1$  and  $\lambda'_2$ .
  - If “MODE FIT” is ON, use the following equations, which incorporate multiplication by the multiplying factor K for  $\lambda_1$  and  $\lambda_2$ , to obtain new  $\lambda_1$  and  $\lambda_2$ .
    - When “MODE FIT” is ON
      - $\lambda'C = (\lambda_2 + \lambda_1)/2$
      - $\lambda_1 = K \times (\lambda_1 - \lambda'C) + \lambda'C$
      - $\lambda_2 = K \times (\lambda_2 - \lambda'C) + \lambda'C$
    - When “MODE FIT” is OFF
      - $\lambda'C = (\lambda'_2 + \lambda'_1)/2$
      - $\lambda'_1 = K \times (\lambda'_1 - \lambda'C) + \lambda'C$
      - $\lambda'_2 = K \times (\lambda'_2 - \lambda'C) + \lambda'C$
  - Obtain spectrum widths from the following equations.
    - $\Delta\lambda = \lambda_2 - \lambda_1$  (when “MODE FIT” is ON)
    - $\Delta\lambda = \lambda'_2 - \lambda'_1$  (when “MODE FIT” is OFF)
  - Obtain center frequencies  $\lambda'C$  from the following equations
    - $\lambda'C = (\lambda_2 + \lambda_1)/2$  (when “MODE FIT” is ON)
    - $\lambda'C = (\lambda'_2 + \lambda'_1)/2$  (when “MODE FIT” is OFF)
- MODE displayed in the data area shall be the number of mode peaks between  $\lambda_1$  and  $\lambda_2$ .

### ENVELOPE Method

This method is used in conjunction with a straight line (envelope) connecting mode peaks to obtain the spectrum widths of the two points, which are lower than the peaks by a configured threshold value (THRESH [dB]), as well as their center wavelengths. The following table shows the details of parameters for the ENVELOPE method.

Parameter	Abbreviation	Default Value	Setting Range	Unit	Description
THRESH 1	TH1	3.00	0.01 to 50.00	dB	Threshold value
THRESH 2	TH2	13.00	0.01 to 50.00	dB	Lower limit value when the number of modes is calculated
K	K	1.00	1.00 to 10.00	-	Multiplying factor

Algorithms differ depending on the number of valid mode peaks. Valid mode peaks mean the mode peaks, among the mode peaks obtained from a mode search, whose level (LOG) is equal to or greater than the line that is below the peak level by the lower limit (THRESH2). Algorithms for these numbers of valid modes are described below.

**In the case of one valid mode peak.**

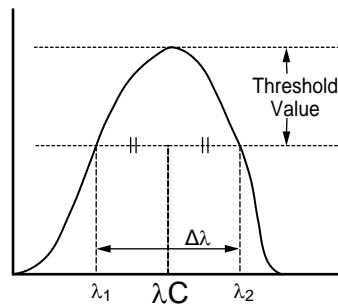

- Perform a mode search to obtain the mode peak.
- Set the wavelengths, which cross the line below the mode peak by the threshold value (THRESH[dB]), to  $\lambda_1$  and  $\lambda_2$ .
- Use the following equations, which incorporate multiplication by the multiplying factor K for  $\lambda_1$  and  $\lambda_2$ , to obtain new  $\lambda_1$  and  $\lambda_2$ .
 
$$\lambda'c = (\lambda_2 + \lambda_1)/2$$

$$\lambda_1 = K \times (\lambda_1 - \lambda'c) + \lambda'c$$

$$\lambda_2 = K \times (\lambda_1 - \lambda'c) + \lambda'c$$
- Obtain the spectrum width from the following equation.
 
$$\Delta\lambda = \lambda_2 - \lambda_1$$
- Obtain the center wavelength  $\lambda c$  from the following equation.
 
$$\lambda c = (\lambda_2 + \lambda_1)/2$$

In the case of two valid mode peaks.

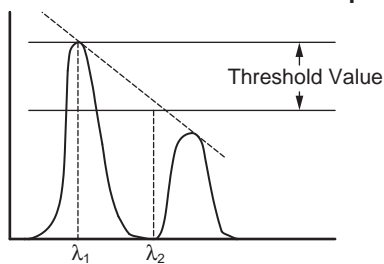

- Set the levels (LOG) of the two valid mode peaks to LG1 and LG2 in order from the left.
- Obtain  $\lambda_1$  and  $\lambda_2$  in the following manner.
  - In the case of  $|LG2-LG1|$  is threshold value (THRESH1[dB]) or less.  
 $\lambda$  becomes  $\lambda_1$  and  $\lambda_2$  from the left in order.
  - In the case of  $|LG2-LG1|$  is larger than threshold value (THRESH1[dB])  
 Connect two valid mode peaks with a straight line (envelope).  
 In the case of  $LG1 > LG2$ , set the wavelength for the left mode peak to  $\lambda_1$ . Set the wavelength of the point, where the line below the peak level by the threshold value (THRESH[dB]) and the straight line (envelope) cross, to  $\lambda_2$ .  
 In the case of  $LG1 < LG2$ , set the wavelength for the right mode peak  $\lambda_2$ . Set the wavelength of the point, where the line below the peak level by the threshold value (THRESH[dB]) and the straight line (envelope) cross, to  $\lambda_1$ .
- Use the following equations, which incorporate multiplication by the multiplying factor K for  $\lambda_1$  and  $\lambda_2$ , to obtain new  $\lambda_1$  and  $\lambda_2$ .
 
$$\lambda'C = (\lambda_2 + \lambda_1)/2$$

$$\lambda_1 = K \times (\lambda_1 - \lambda'C) + \lambda'C$$

$$\lambda_2 = K \times (\lambda_2 - \lambda'C) + \lambda'C$$
- Obtain the spectrum width from the following equation.
 
$$\Delta\lambda = \lambda_2 - \lambda_1$$
- Obtain the center wavelength  $\lambda C$  from the following equation
 
$$\lambda C = (\lambda_2 + \lambda_1)/2$$

In the case of three or more valid mode peaks.

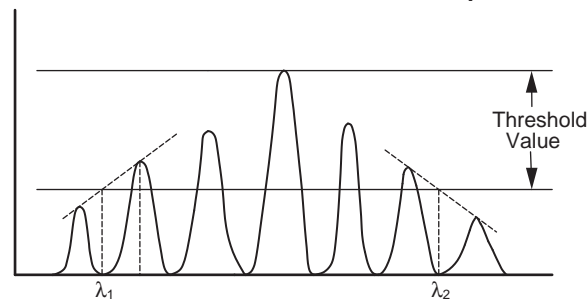

- Set the levels (LOG) of three or more valid mode peaks to LG1, LG2 ••• LGn in order from the left. Set the level of the mode peak at the highest level to LGp.
- Obtain  $\lambda_1$  in the following manner:
  - In the case of  $|LGp-LG1|$  is threshold value (THRESH1[dB]) or less  
Set the wavelength of the LG1 mode peak to  $\lambda_1$ .
  - In the case of  $|LGp-LG1|$  is larger than threshold value (THRESH1[dB])
    - i Obtain the leftmost mode peak with  $|LGp-THRESH1|$  or more.
    - ii Use a straight line to connect the mode peak obtained in (i) with the mode peak on the left of (i) and also at the highest level.
    - iii Set the point, where the line of  $|LGp-THRESH1|$  and the straight line (envelope) cross, to  $\lambda_1$ .
- Obtain  $\lambda_2$  in the following manner:
  - In the case of  $|LGp-LGn|$  is threshold value (THRESH1[dB]) or less.  
Set the wavelength of the LG1 mode peak to  $\lambda_2$ .
  - In the case of  $|LGp-LGn|$  is larger than threshold value (THRESH1[dB])
    - i Obtain the rightmost mode peak with  $|LGp-THRESH1|$  or more.
    - ii Use a straight line to connect the mode peak obtained in (i) with the mode peak on the right of (i) and also at the highest level.
    - iii Set the point, where the line of  $|LGp-THRESH1|$  and the straight line (envelope) cross, to  $\lambda_2$ .
- Use the following equations, which incorporate multiplication by the multiplying factor K for  $\lambda_1$  and  $\lambda_2$ , to obtain new  $\lambda_1$  and  $\lambda_2$ .
 
$$\lambda'C = (\lambda_2 + \lambda_1)/2$$

$$\lambda_1 = K \times (\lambda_1 - \lambda'C) + \lambda'C$$

$$\lambda_2 = K \times (\lambda_2 - \lambda'C) + \lambda'C$$
- Obtain the spectrum width from the following equation.
 
$$\Delta\lambda = \lambda_2 - \lambda_1$$
- Obtain the center wavelength  $\lambda_C$  from the following equation.
 
$$\lambda_C = (\lambda_2 + \lambda_1)/2$$

### RMS Method

Use the RMS method to obtain the spectrum width and its center wavelength. Following table shows the details of parameters for the RMS method.

Parameter	Abbreviation	Default Value	Setting Range	Unit	Description
THRESH	TH	20.00	0.01 to 50.00	dB	Threshold value
K	K	2.00	1.00 to 10.00	-	Multiplying factor

Algorithms for the analysis are described below.

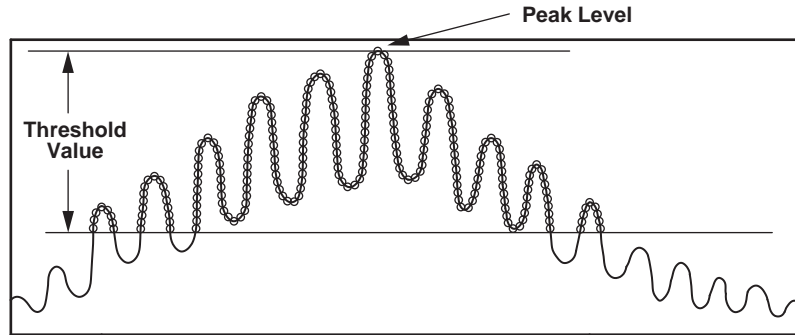

- Take out the data points exceeding the threshold value TH, within the displayed waveform, and find the spectrum width by the following calculation.
- When the wavelength at each point is  $\lambda_i$  and the level at the point is  $P_i$ , the mean wavelength  $\lambda_c$  can be found by the following expression.

$$\lambda_c = \frac{\sum P_i \times \lambda_i}{\sum P_i}$$

- By using the mean wavelength  $\lambda_c$ , find the spectrum width  $\Delta\lambda$  by the following expression.

$$\Delta\lambda = \sqrt{\frac{\sum P_i \times (\lambda_i - \lambda_c)^2}{\sum P_i}}$$

**PEAK RMS Method**

Use the PEAK RMS method to obtain the spectrum width and its center wavelength. Following table shows the details of the parameters for the PEAK RMS method.

Parameter	Abbreviation	Default Value	Setting Range	Unit	Description
THRESH	TH	20.00	0.01 to 50.00	dB	Threshold value
K	K	2.00	1.00 to 10.00	-	Multiplying factor

Algorithms for the analysis are described below.

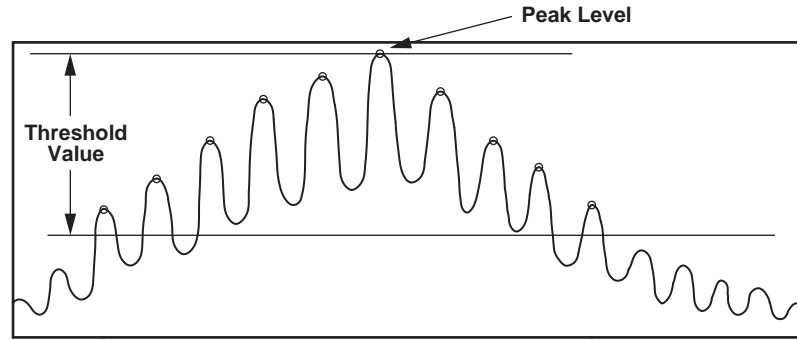

- Take out the data points exceeding the limit value TH, within the displayed waveform, and find the spectrum width by the following calculation. The mode peak count above the TH is shown in the MODE data area.
- When the wavelength at beach point is  $\lambda_i$  and the level at the point is  $P_i$ , the mean wavelength  $\lambda_c$  can be found by the following expression.

$$\lambda_c = \frac{\sum P_i \times \lambda_i}{\sum P_i}$$

- By using the mean wavelength  $\lambda_c$  obtained in above discription, find the spectrum width  $\Delta\lambda$  by the following expression.

$$\Delta\lambda = \sqrt{\frac{\sum P_i \times (\lambda_i - \lambda_c)^2}{\sum P_i}}$$

### NOTCH Width Measurement

Obtain a bottom level. Then, obtain the NOTCH width for the bottom level and its center wavelength.

Following table shows the details of parameters for NOTCH analyses.

Parameter	Abbreviation	Default Value	Setting Range	Unit	Description
THRESH	TH	3.00	0.01 to 50.00	dB	Threshold value
K	K	1.00	1.00 to 10.00	-	Multiplying factor
TYPE	TYPE	BOTTOM	BOTTOM / PEAK	-	Reference position for search

Algorithms for analyses are described here. They differ depending on the types of analysis (BOTTOM/PEAK). Algorithms for each type of analysis are described below.

#### When “TYPE” is BOTTOM

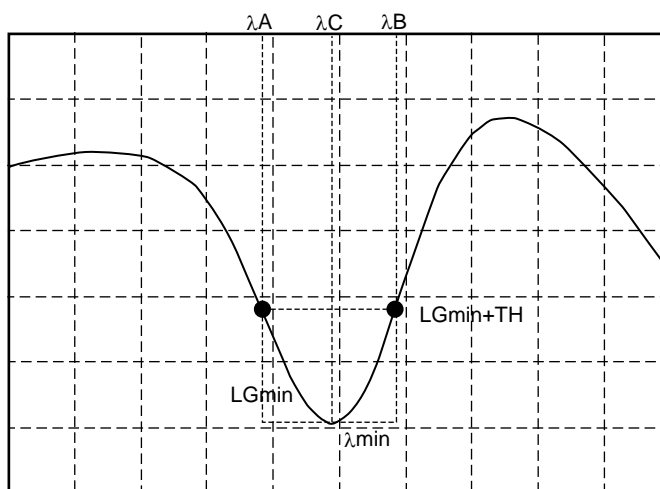

- Obtain the minimum level “LGmin.” Also, set the wavelength of this point to  $\lambda_{min}$ .
- Set the rightmost wavelength, which is located on the left of  $\lambda_{min}$  and which crosses the level (LOG) of  $|LGmin + \text{threshold value (THRESH[dB])}|$ , to  $\lambda_A$ .
- Set the leftmost wavelength, which is located on the right of  $\lambda_{min}$  and which crosses the level (LOG) of  $|LGmin + \text{threshold value (THRESH[dB])}|$ , to  $\lambda_B$ .
- Obtain  $\lambda_A$  and  $\lambda_B$  through multiplication by the value which is set to the multiplying factor K.

$$\lambda'C = (\lambda_B + \lambda_A)/2$$

$$\lambda_A = K \times (\lambda_A - \lambda'C) + \lambda'C$$

$$\lambda_B = K \times (\lambda_B - \lambda'C) + \lambda'C$$

- Obtain the NOTCH width from the following equation.

$$\Delta\lambda = \lambda_A - \lambda_B$$

- Obtain the center wavelength  $\lambda_C$  from the following equation.

$$\lambda_C = (\lambda_A + \lambda_B)/2$$

When "TYPE" is PEAK.

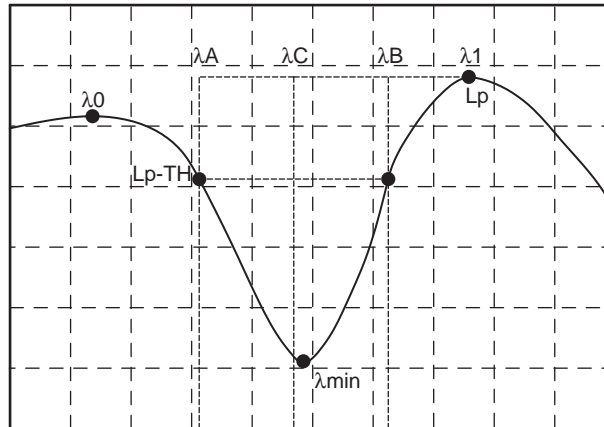

- Obtain the minimum level "LGmin." Also, set the wavelength of this point to  $\lambda_{min}$ .
- Obtain LG0 at the peak level (LOG) on the left of LGmin. Also, set the wavelength of this point to  $\lambda_0$ .
- Obtain LG1 at the peak level (LOG) on the right of LGmin. Also, set the wavelength of this point to  $\lambda_1$ .
- Of LG0 and LG1, set whichever is greater to  $L_p$ .
- Between  $\lambda_0$  and  $\lambda_1$ , set the leftmost wavelength crossing the level (LOG) of  $|L_p - \text{threshold value (THRESH[dB])}|$  to  $\lambda_A$ .
- Between  $\lambda_0$  and  $\lambda_1$ , set the rightmost wavelength crossing the level (LOG) of  $|L_p - \text{threshold value (THRESH[dB])}|$  to  $\lambda_B$ .
- Obtain  $\lambda_A$  and  $\lambda_B$  through multiplication by the value which is set to the multiplying factor K.

$$\lambda'C = (\lambda_B + \lambda_A)/2$$

$$\lambda_A = K \times (\lambda_A - \lambda'C) + \lambda'C$$

$$\lambda_B = K \times (\lambda_B - \lambda'C) + \lambda'C$$

- Obtain the NOTCH width from the following equation.

$$\Delta\lambda = \lambda_A - \lambda_B$$

- Obtain the center wavelength  $\lambda_C$  from the following equation.

$$\lambda_C = (\lambda_A + \lambda_B)/2$$

## Appendix 3 Details of Each Analytical Functions

This section describes the algorithms for analyses using the ANALYSIS 1 soft key in the ANALYSIS. ANALYSIS 1 provides such functions as collective analysis of various light sources, POWER analysis, SMSR analysis, and PMD analysis.

### SMSR Analysis Function

Use the optical spectrum after the measurement of DFB-LD to analyze the SMSR (Side Mode Suppression Ratio) of DFB-LD.

Following table shows the details of parameters for NOTCH analyses.

Parameter	Abbreviation	Default Value	Setting Range	Unit	Description
SMSR MODE	MODE	SMSR1	SMSR1/SMSR2	-	Execution mode during SMSR measurement
SMSR MASK	MASK	±0.00	0.00 to 99.99	nm	Setting of near-peak mask range during SMSR1 measurement

Algorithms for analyses are described here. They differ depending on the SMSR modes. Algorithms for each mode of analysis are described below.

#### SMSR1

The next highest mode peak after excluding the highest mode peak level and the mask setting range is defined as the side mode.

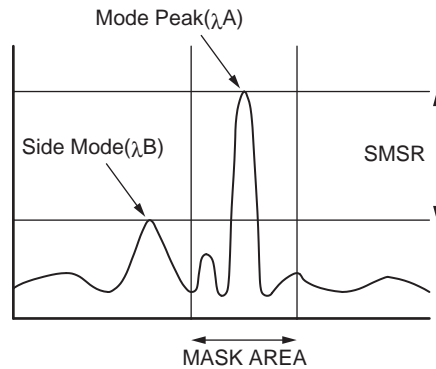

Algorithms of analysis for the SMSR1 mode are as follows:

- Perform a mode search to obtain the mode peak.
- Of the obtained mode peaks, set the point of the mode peak at the highest level (LOG) to PA. Also, set the wavelength value of this point to λA.
- Except for the mode peaks within the range of  $PA \pm 1000 \times (SMSR\ MASK)/SPAN$ , set the wavelength of the highest mode peak, which is next to PA, to λB. If a relevant point does not exist, set the wavelength value at the highest level outside the range of  $PA \pm 1000 \times (SMSR\ MASK)/SPAN$  to λB. If there is more than one λB, set the leftmost wavelength value to λB. Also, set the levels (linear values) for each point of λA and λB to LA and LB.
- Obtain SMSR and  $\Delta\lambda$  from the following equations.  

$$SMSR = LA / LB$$

$$\Delta\lambda = \lambda B - \lambda A$$

**SMSR2**

Of the highest mode peak level and the mode peaks on either side, whichever is higher is defined as the side mode.

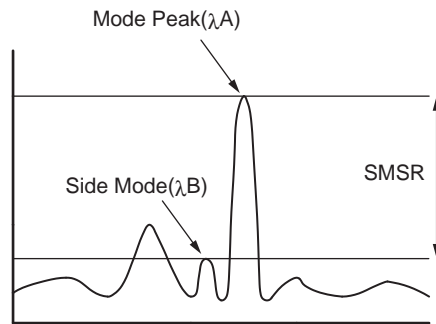

Algorithms of analysis for the SMSR1 mode are as follows.

- Perform a mode search to obtain the mode peak.
- Of the obtained mode peaks, set the wavelength value of the mode peak at the highest level (LOG) to  $\lambda A$ .
- Of the mode peaks on either side of  $\lambda A$ , set the wavelength value at the higher level to  $\lambda B$ . If there is no mode peak other than  $\lambda A$ ,  $\lambda B = \lambda A$  shall be applicable.
- Also, set the levels (linear values) for each point of  $\lambda A$  and  $\lambda B$  to  $LA$  and  $LB$ .
- Obtain SMSR and  $\Delta\lambda$  from the following equations.

$$SMSR = LA / LB$$

$$\Delta\lambda = \lambda B - \lambda A$$

### POWER Analysis Function

This function allows the user to add up level values of measured waveforms, thereby enabling the calculation of total power. It would be more convenient if the between line markers search function and the zoom area search function were also used for the POWER analysis.

Following table shows the details of the parameters for POWER analysis.

Parameter	Abbreviation	Default Value	Setting Range	Unit	Description
POWER OFFSET	OFST	0.00	-10.00 to 10.00	dB	Compensation value in power measurement

Algorithms for the analysis are as follows.

- Obtain actual wavelength resolutions for all display points. (Use the table to interpolate the values for  $\lambda_x = \lambda_{SHIFT} + \lambda_{OFST}$ .)

While in the vacuum wavelength mode (**MEAS WL AIR/VACUUM** soft key in the **SET UP**), use the following equation to obtain  $\lambda_x$ .

$$\lambda_0 = \lambda + \lambda_{SHIFT}$$

$$\lambda_x = \lambda_0 / N(\lambda_0) + \lambda_{OFST}$$

If the display mode on the **X** axis (**HORIZON SCALE nm/THz** soft key in the **SET UP**) is the frequency display mode, use the equation below to convert an actual resolution (frequency)  $R_i$  for all display points to a wavelength value.

$$R_i = (\lambda_i \times \lambda_i \times R_{fi}) / C$$

$\lambda_i$  : Wavelength (nm) at each point

$R_{fi}$  : Actual resolution(THz)

$C$  : Speed of light in the vacuum( $2.99792458 \times 10^8$ [m/s])

- Set the actual resolution for the  $i$ th point to  $R_i$ , while setting the level to  $L_i$ .
- Obtain the total power in the equation below.

$$POWER = \frac{SPAN}{SAMPLE - 1} \times \sum \frac{L_i}{R_i} \times POWEROFFSET$$

- If the display scale for the waveform and level axis of A-B(LOG) and B-A(LOG), which are calculation functions of trace C, is set to dBm/nm (**LEVEL UNIT dBm/dBm/nm** soft key in the **LEVEL**) display, obtain the total power from the equation below.

$$POWER = \frac{SPAN}{SAMPLE - 1} \times \sum L_i \times POWEROFFSET$$

### PMD Analysis Function

Measured waveforms are used to analyze PMD values.

Following table shows the details of the parameter for PMD analysis.

Parameter	Abbreviation	Default Value	Setting Range	Unit	Description
THRESH	TH	10.00	0.01 to 50.00	dB	Threshold value

Algorithms of the analysis are as follows.

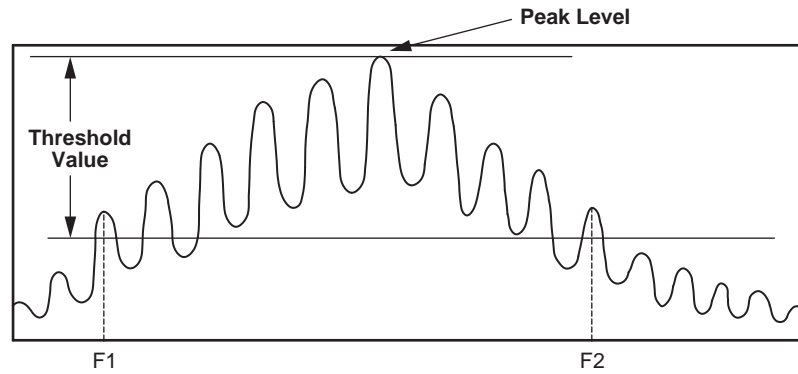

- Perform a mode search to obtain mode peaks.
- Of these mode peaks, set the ones whose level (LOG) is equal to or greater than the line that is below the peak level by the lower limit (THRESH), to the valid mode peaks.
- Set the frequency of the leftmost valid mode peak to F1 (THz).
- Set the frequency of the rightmost valid mode peak to F2 (THz).
- Set the number of mode peaks between F1 and F2 to N.
- Obtain the PMD value from the following equation.

$$PMD = (N-1) / (F2-F1)$$

### DFB-LD Analysis Function

The following parameters for DFB-LD light sources are analyzed collectively.

- -XdB WIDTH
- SMSR

Following table shows the details of parameters for DFB-LD analysis.

Parameter	Abbreviation	Default Value	Setting Range	Unit	Description
-XdB WIDTH	ALGO	THRESH	ENVELOPE / THRESH / RMS /PK-RMS	-	
	THRESH	20.00	0.01 to 50.00	dB	
	THRESH2	20.00	0.01 to 50.00	dB	Valid only when ALGO is ENVELOPE.
	K	1.00	1.00 to 10.00	-	
	MODE FIT	OFF	ON / OFF	-	Valid only when ALGO is THRESH.
	MODE DIFF	3.00	0.01 to 50.00	dB	
SMSR	SMSR MODE	SMSR1	SMSR1 / SMSR2	-	
	SMSR MASK	±0.00	0.00 to 99.99	nm	
	MODE DIFF	3.00	0.01 to 50.00	dB	

Concerning the algorithms for DFB-LD analysis, refer to data calculation algorithms for spectrum widths and SMSR analysis algorithms.

**FP-LD Analysis Function**

The following parameters for FP-LD light sources are analyzed collectively

- SPECTRUM WIDTH
- MEAN WAVELENGTH
- TOTAL POWER
- MODE NO.

Following table shows the details of parameters for FP-LD analysis.

Parameter	Abbreviation	Default Value	Setting Range	Unit	Description
SPECTRUM WIDTH	ALGO	PK-RMS	ENVELOPE / THRESH / RMS / PK-RMS	-	
	THRESH	20	0.01 to 50.00	dB	
	THRESH2	20	0.01 to 50.00	dB	Valid only when ALGO is ENVELOPE.
	K	2	1.00 to 10.00	-	
	MODE FIT	OFF	ON / OFF	-	Valid only when ALGO is THRESH.
	MODE DIFF	3	0.01 to 50.00	dB	
MEAN WAVELENGTH	ALGO	PK-RMS	ENVELOPE / THRESH / RMS / PK-RMS	-	
	THRESH	20	0.01 to 50.00	dB	
	THRESH2	20	0.01 to 50.00	dB	Valid only when ALGO is ENVELOPE.
	K	2	1.00 to 10.00	-	
	MODE FIT	OFF	ON / OFF	-	Valid only when ALGO is THRESH.
	MODE DIFF	3	0.01 to 50.00	dB	
TOTAL POWER	OFFSET LEVEL	0	-10.00 to 10.00	dB	
MODE NO.	ALGO	PK-RMS	ENVELOPE / THRESH / RMS / PK-RMS	-	
	THRESH	20.00	0.01 to 50.00	dB	
	THRESH2	20.00	0.01 to 50.00	dB	Valid only when ALGO is ENVELOPE.
	K	2.00	1.00 to 10.00	-	
	MODE FIT	OFF	ON / OFF	-	Valid only when ALGO is THRESH.
	MODE DIFF	3.00	0.01 to 50.00	dB	

Concerning the algorithms for FP-LD analysis, refer to data calculation algorithms for spectrum widths and power analysis algorithms.

### LED Analysis Function

The following parameters for LED light sources are analyzed collectively.

- SPECTRUM WIDTH
- MEAN WAVELENGTH
- TOTAL POWER

Following table shows the details of parameters for LED analysis.

Parameter	Abbreviation	Default Value	Setting Range	Unit	Description
SPECTRUM WIDTH	ALGO	THRESH	ENVELOPE / THRESH / RMS / PK-RMS	-	
	THRESH	3	0.01 to 50.00	dB	
	THRESH2	20	0.01 to 50.00	dB	Valid only when ALGO is ENVELOPE.
	K	1	1.00 to 10.00	-	
	MODE FIT	OFF	ON / OFF	-	Valid only when ALGO is THRESH.
	MODE DIFF	3	0.01 to 50.00	dB	
MEAN WAVELENGTH	ALGO	RMS	ENVELOPE / THRESH / RMS / PK-RMS	-	
	THRESH	20	0.01 to 50.00	dB	
	THRESH2	20	0.01 to 50.00	dB	Valid only when ALGO is ENVELOPE.
	K	2	1.00 to 10.00	-	
	MODE FIT	OFF	ON / OFF	-	Valid only when ALGO is THRESH.
	MODE DIFF	3	0.01 to 50.00	dB	
TOTAL POWER	OFFSET LEVEL	0	-10.00 to 10.00	dB	

Concerning the algorithms for LED analysis, refer to data calculation algorithms for spectrum widths and power analysis algorithms.

## Appendix 4 Detailed Explanations of WDM Analysis Function

This function provides the analyses of NOISE level and SNR in each mode within the measurement range of WDM waveforms.

### Items for analysis

NO.:	Channel No. i
WAVELENGTH:	Center wavelength $\lambda_i$ of the channel
LEVEL:	Level (peak level – noise level) $L_i$ of the channel
OFFSET WL:	Relative wavelength to the wavelength of the reference channel (REF)
OFFSET LVL:	Relative level to the level of the reference channel (REF)
SPACING:	Wavelength spacing to the adjacent channel
LVL DIFF:	Level difference from then adjacent channel
NOISE:	Noise level $LN_i$ of the channel
SNR:	SNR value $SN_i$ of the channel
GRID WL:	Nearest GRID wavelength to the channel
MEAS WL:	Center wavelength $\lambda_i$ of the channel
REL WL:	Relative wavelength to the nearest GRID wavelength of the channel

### **Note**

Indications of dBm/nm and dBm/THz are forcibly changed to dBm indications before execution.

### List of Parameters

#### Related to Channel Detection

Parameter	Default	Setting Range	Unit	Description
THRESH	20.0	0.1 to 99.9	dB	Threshold value for channel detection.
MODE DIFF	3.0	0.0 to 50.0	dB	Minimum value for peak/bottom difference during channel detection.
DISPLAY MASK	OFF	OFF, -100.0 to 0.0	dBm	Levels equal to or below this level are not detected as WDM channels.

Related to SNR Analysis

Parameter	Default	Setting Range	Unit	Description
NOISE ALGO	AUTO-FIX	AUTO-FIX MANUAL-FIX AUTO-CTR MANUAL-CTR PIT	-	Selection of algorithms for noise level measurement.
NOISE AREA	0.40nm	0.01 to 10.00nm	nm	A range of waveform data for use in noise level analysis is specified as a range centering on channel wavelengths. When N_ALGO is: <ul style="list-style-type: none"> <li>• AUTO-FIX "AUTO"</li> <li>• MANUAL-FIX ** **</li> <li>• AUTO-CTR "Between Ch"</li> <li>• MANUAL-CTR "Between Ch"</li> <li>• PIT "-"</li> </ul>
MASK AREA	0.20nm	0.01 to 10.00nm	nm	Specify the signal optical spectrum range to be masked within the waveform data, while using the channel wavelength as its center. When N_ALGO is: <ul style="list-style-type: none"> <li>• AUTO-FIX "-"</li> <li>• MANUAL-FIX When F_ALGO is LINEAR: "-"</li> <li>Other cases: input of parameter values</li> <li>• AUTOL-CTR "-"</li> <li>• MANUAL-CTR When F_ALGO is LINEAR: "-"</li> <li>Other cases: input of parameter values</li> </ul> Limiter is applied during input to ensure NOISE AREA is MASK AREA or more. <ul style="list-style-type: none"> <li>• PIT "-"</li> </ul>
FITTING ALGO	LINEAR	LINEAR GAUSS LORENZ 3RD POLY 4TH POLY 5TH POLY	-	Selection of a fitting algorithm for obtaining noise levels.
NOISE BW	0.10nm	0.01 to 1.00nm	nm	Setting of noise bandwidth.
DUAL TRACE	OFF	ON/OFF	-	OFF: Active trace is handled as the target for analysis. ON: Wavelengths and levels are calculated from TRACE A. Noise levels are calculated from TRACE B.

**Appendix 4 Details of WDM Analysis Function**

**Related to display**

Parameter	Default	Setting Range	Unit	Description
DISPLAY TYPE	ABSOLUTE	ABSOLUTE RELATIVE DRIFT(MEAS) DRIFT(GRID)	-	Setting of the format to display wavelengths, levels, noises, and SNRs, which are the results of analyses. ABSOLUTE: display of absolute values RELATIVE: display of relative values compared to GRID. DRIFT(MEAS): display of drift values by using wavelengths measured previously as references. DRIFT(GRID): display of drift values by using the grid wavelengths as references.
CH RELATION	OFFSET	OFFSET SPACING	-	Setting of the format to display wavelengths between channels and level relative values during DISPLAY: ABSOLUTE. This parameter is valid only when DISPLAY is set to ABSOLUTE. OFFSET: Display of offset values by using one arbitrary channel as the reference. SPACING: Display of offset values compared to an adjacent channel
REF CH	HIGHEST	HIGHEST ****	-	Setting of the reference channel when CH RELATION is set to OFFSET. This parameter is valid only when DISPLAY is set to ABSOLUTE and also when CH RELATION is set to OFFSET. HIGHEST: A channel at the highest level is used as the reference. ****: A ****th channel is used as the reference.
MAX/MIN RESET	-	-	-	If pressed, MAX/MIN is RESET. Button valid only when DISPLAY is set to DRIFT
OUTPUT SLOPE	OFF	ON/OFF	-	ON/OFF of the function to obtain the least square approximation line of the channel peak.
POINT DISPLAY	ON	ON/OFF	-	ON/OFF of the function to display the data range used for fitting into the waveform window.

## Algorithm for Analysis

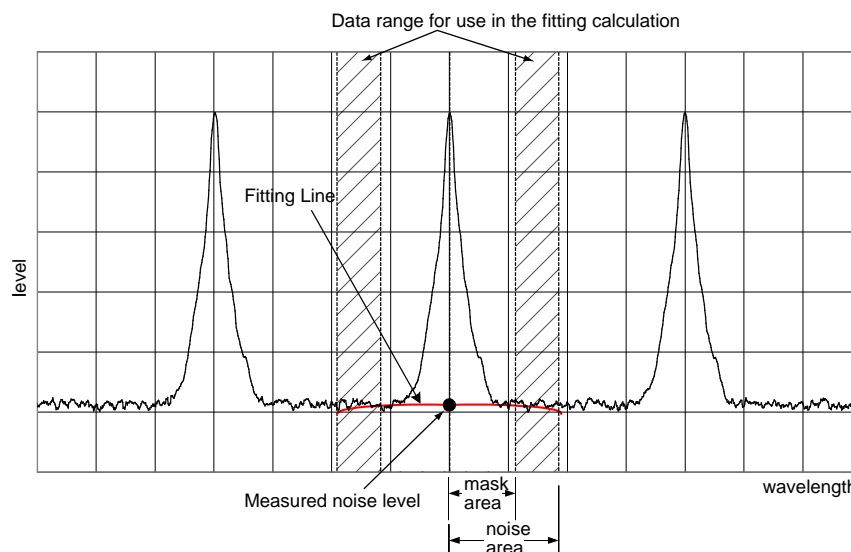

1. Apply channel detection to measured waveform data using the following procedure:
  - Find all maximum points and minimum points to obtain mode peaks where peak/bottom differences between maximum points and minimum points on both sides are equal to or greater than MODE DIFF.
  - Of the obtained mode peaks, choose only the ones whose level difference compared to the highest peak is equal to or greater than THRESH. Note, however, that mode peaks with a level difference equal to or less than DISPLAY MASK shall be excluded. The number of mode peaks chosen in this manner shall be the Number of Channels "N."
2. Obtain the wavelength  $\lambda_i$  of each mode peak.
3. Obtain the level  $L_{Pi}$  of each mode peak.
4. Obtain the center wavelength  $\lambda_i$  of each mode peak, which is the center of the two points below the mode peak  $\lambda_i$  by  $A[\text{dB}]$  both on the left and on the right. ( $A[\text{dB}]$  shall be either 3 dB or the setting value of MODE DIFF, whichever is smaller.)
5. Follow the setting of the parameter NOISE ALGO to determine the noise area and mask area for performing the NOISE fitting.  
(If the mask area is set outside the noise area when the channel wavelength  $\lambda_i$  is the center, the mask area and the noise area will become the same value.)
6. Obtain the measurement resolution  $R_{Bi}$  of each channel from the values stored in the AQ6370.
7. According to the setting of the parameter FITTING ALGO, generate fitting waveforms from the noise area and mask area determined in 5 and obtain the level at the center wavelength  $\lambda_i$  as the noise level  $L_{Ni}$ .
8. Use the peak level  $L_{Pi}$  and the noise level  $L_{Ni}$  obtained in 3 and 7 to obtain the level  $L_i$  of each channel from the following equation.
 
$$L_i = L_{Pi}(\text{linear}) - L_{Ni}(\text{linear})$$
9. Obtain the normalized noise level  $L_{NNi}$  from the equation below.
 
$$L_{NNi} = [L_{Ni}(\text{LOG}) - 10 \times \text{Log}(R_{Bi}[\text{nm}])] + 10 \times \text{Log}(\text{NBW})$$
 NBW = noise bandwidth (configurable parameter)
10. Use the mode peak level  $L_i$  obtained in 8 and 9 and the normalized noise level  $L_{NNi}$  to obtain  $S_{Ni}$  from the following equation.
 
$$S_{Ni} = L_i - L_{NNi}$$
11. Display the results of foregoing analyses according to the settings of the parameter DISPLAY SETTING.

## Automatic Parameter Setting Function

This unit provides the noise area/mask area automatic setting function. To activate the automatic setting, set the algorithm to AUTO-FIX or AUTO-CTR.

### AUTO-FIX

#### Noise Algorithm

Obtain the left and right noise areas (NA\_Ri, NA\_Li) of each channel according to the number of detected WDM channels as follows:

##### When the number of WDM channels “n” is 1

Internally obtain the measurement resolution of SNi calculation trace and the value of the noise measurement point NOISE AREA in accordance with the resolution, and then obtain the values from the following equations.

$$NA\_Ri = \lambda i + NOISE\ AREA$$

$$NA\_Li = \lambda i - NOISE\ AREA$$

##### When the number of WDM channels “n” is 2 or more

Obtain the channel spacing of each channel (spacing of  $\lambda i$ .) With the minimum spacing set to SPACING as well as NOISE AREA = SPACING / 2, obtain the NOISE AREA.

Finally, obtain the values from the following equations.

$$NA\_Ri = \lambda i + NOISE\ AREA \ (i = 1, 2, \dots, n)$$

$$NA\_Li = \lambda i - NOISE\ AREA \ (i = 1, 2, \dots, n)$$

#### Fitting Algorithm

While the setting is at AUTO-FIX, LINEAR is used for the fitting algorithm, which is calculated as follows.

- Obtain ELi and ERi as the level (LOG) of each position of the noise areas NA\_Li and NA\_Ri.
- Use the data of the straight line connecting the two points of ELi and ERi to fill the inside of the fitting range.
- Set the level of  $\lambda i$  of the data generated in the fitting to the noise level LNi.

#### Note

---

Due to being set to LINEAR, it is not possible to set the mask areas.

---

### AUTO-CTR

#### Noise Algorithm

Obtain the left and right noise areas (NA\_Ri, NA\_Li) of each channel according to the number of detected WDM channels as follows (while treating the center points between channels as NA\_Ri and NA\_Li).

##### When the number of WDM channels “n” is 1

Internally obtain the measurement resolution of SNi calculation trace and the value of the noise measurement point NOISE AREA in accordance with the resolution, and then obtain the values from the following equations.

$$NA\_Ri = \lambda i + NOISE\ AREA$$

$$NA\_Li = \lambda i - NOISE\ AREA$$

##### When the number of WDM channels “n” is 2 or more

$$\lambda N1 = (3\lambda_1 - \lambda_2)/2$$

$i=2, 3, \dots, n$

$$\lambda Ni = (\lambda_i - \lambda_{i-1})/2$$

$$\lambda Nn+1 = (3\lambda_n - \lambda_{n-1})/2$$

If the above values are calculated, the following results will be generated.

$i=1, 2, \dots, n$

$$NA\_Li = \lambda Ni$$

$$NA\_Ri = \lambda Ni+1$$

**Fitting Algorithm**

While the setting to AUTO-CTR, LINEAR is used for the fitting algorithm, which is calculated as follow.

- Obtain ELi and ERi as the level (LOG) of each position of the noise areas NA\_Li and NA\_Ri.
- Use the data of the straight line connecting the two points of ELi and ERi to fill the inside of the fitting range.
- Set the level of  $\lambda_i$  of the data generated in the fitting to the noise level LNi.

**Note**

Due to being set to LINEAR, it is not possible to set the mask areas.

**PIT****Noise Algorithm**

Obtain the noise areas for measured waveform to the minimum level position of a before the next channel in each channel.

When inside noise areas obtain at the left and right noise areas of each channel. outside noise areas is applied.

**When the number of WDM channels “n” is 1**

Internally obtain the measurement resolution of SNi calculation trace and the value of the noise measurement point NOISE AREA in accordance with the resolution, and then obtain the values from the following equations.

$$NA\_Ri = \lambda_i + NOISE\ AREA$$

$$NA\_Li = \lambda_i - NOISE\ AREA$$

**When the number of WDM channels “n” is 2 or more**

i=1

$$NA\_Li = \lambda_i - (\lambda_{Ni} - \lambda_i)$$

$$NA\_Ri = \lambda_{Ni}$$

i=2,3,...,n-1

$$NA\_Li = \lambda_N(i - 1)$$

$$NA\_Ri = \lambda_{Ni}$$

i=n

$$NA\_Li = \lambda_N(i - 1)$$

$$NA\_Ri = \lambda_i + (\lambda_i - \lambda_N(i - 1))$$

**Fitting Algorithm**

While the setting to PIT, LINEAR is used for the fitting algorithm, which is calculated as follows.

- Obtain ELi and ERi as the level (LOG) of each position of the noise areas NA\_Li and NA\_Ri.
- Use the data of the straight line connecting the two points of ELi and ERi to fill the inside of the fitting range.
- Set the level of  $\lambda_i$  of the data generated in the fitting to the noise level LNi.

**Note**

Due to being set to LINEAR, it is not possible to set the mask areas

### Setting of the Parameter “DUAL TRACE”

This function enables more precise analyses by measuring waveforms with different measurement resolutions at trace A and trace B and also by performing measurements with resolutions different in noise level from the signal level of each channel.

When “DUAL TRACE” is ON, targets for the analysis of each trace will be:

- TRACE A: trace subject to channel detection
- TRACE A: calculation traces  $\lambda_i$  and  $L_i$
- TRACE B: noise level  $LN_i$  calculation trace

### OUTPUT SLOPE Function

The parameter “OUTPUT SLOPE” provides a function to obtain the least square approximation curve of channel peaks. This function makes it possible to measure gain tilts. If “OUTPUT SLOPE” is set to ON, results will be displayed in the waveform display section and in the analysis table.

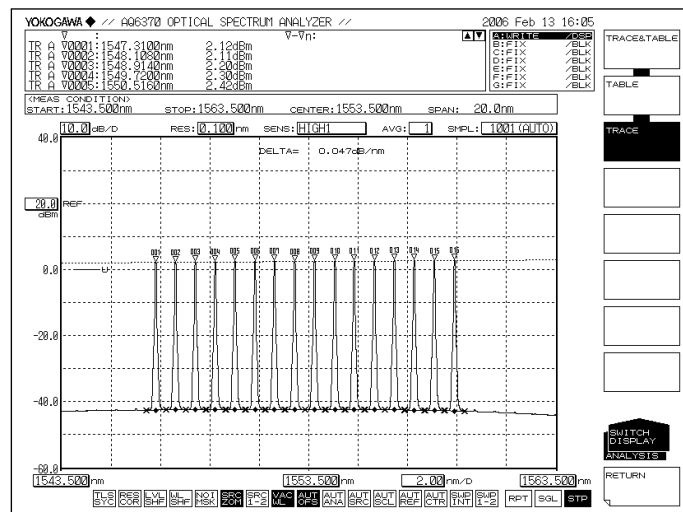

## Items to be Displayed When DISPLAY is Set ABSOLUTE

Results of analyses are displayed in absolute values.

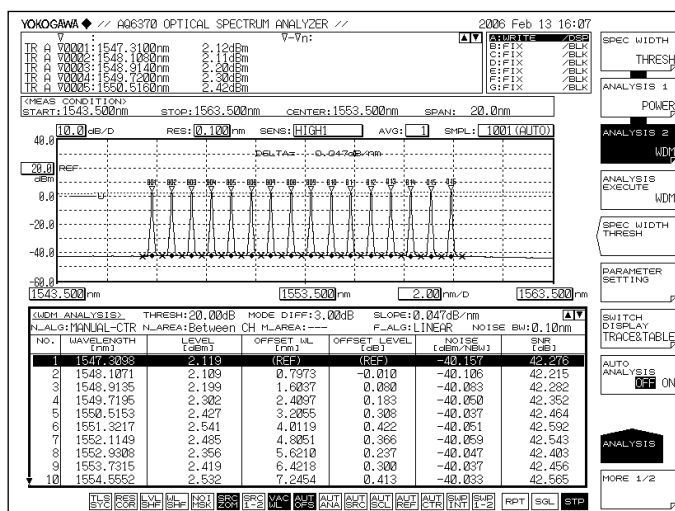

### Explanations of display items

- NO: Channel number
- WAVELENGTH: Center wavelength of the channel
- LEVEL: Level of the channel (peak level – noise level)
- OFFSET WL: Relative wavelength to the wavelength of the reference channel (REF)
- OFFSET LVL: Relative level to the wavelength of the reference channel (REF)
- SPACING: Wavelength spacing with the adjacent channel
- LVL DIFF: Level difference from the adjacent channel
- NOISE: Noise level of the channel
- SNR: SNR value of the channel

- OFFSET WL/LVL is displayed when the parameter CH RELATION is "OFFSET."
- SPACING and LVL DIFF are displayed when the parameter CH RELATION is "SPACING."
- When ABSOLUTE and CH RELATION are OFFSET, it is possible either to set the reference channel to the mode peak with the highest level or to set a mode peak that will become the reference arbitrarily.
  - When REF CH is HIGHEST  
The WDM mode peak with the highest level shall be the reference. The wavelength difference and level difference (LOG) compared to it shall be OFFSET WL and OFFSET LVL of each WDM mode peak.
  - When REF CH is \*\*\*  
REF CHANNEL \*\*\* shall be the reference. The wavelength difference and level difference (LOG) against it shall be OFFSET WL and OFFSET LVL of each WDM mode peak. (If the \*\*\*th mode peak does not exist, the WDM mode peak on the longest wavelength shall be the reference.)

RELATIVE

Of the analytical results, wavelength values are displayed as relative values to the values in the grid table.

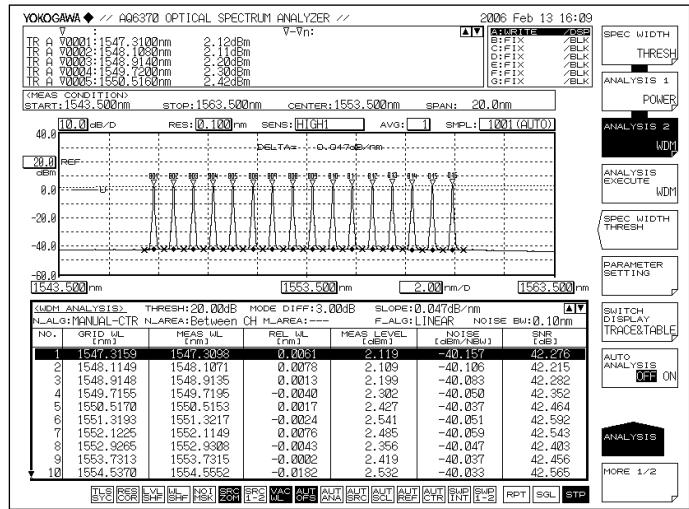

Explanations of display items

- NO: Channel number
- GRID WL: GRID wavelength of the channel
- MEAS WL: Center wavelength of the channel
- REL WL: Relative wavelength to the GRID wavelengths of the channel
- MEAS LVL: Level of the channel (peak level – noise level)
- NOISE: Noise level of the channel
- SNR: SNR value of the channel

### DRIFT(MEAS)

Wavelengths measured previously are used as references to display wavelength/level changes (drifts).

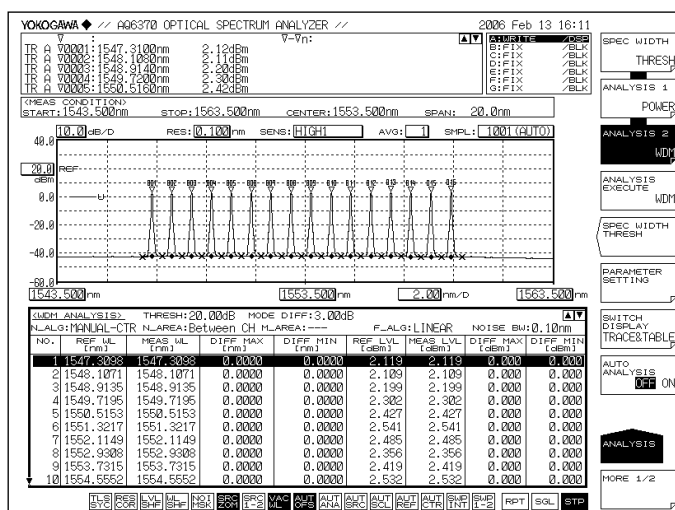

### Explanations of display items

- NO: Channel number
- REF WL: Reference wavelength of the channel (previous wavelength measured)
- MEAS WL: Center wavelength of the channel
- DIFF MAX (wavelength): Maximum value of the relative wavelength to the reference wavelength of the channel
- DIFF MIN (wavelength): Minimum value of the relative wavelength to the reference wavelength of the channel
- REF LVL: Reference level of the channel (previous measurement level)
- MEAS WL: Measurement level of the channel
- DIFF MAX (level): Maximum value of the relative level to the reference level of the channel
- DIFF MIN (level): Minimum value of the relative level to the reference level of the channel

Reference wavelength/level can be changed under the following conditions.

- Active trace waveform data when MAX/MIN RESET is set by the parameter.
- The first waveform data measured when wavelength axes (SPAN WL/START WL/STOP WL) were changed according to the measurement conditions.

**DRIFT(GRID)**

Grid wavelengths are used as references to display wavelength/level changes (drifts). Note that reference levels are previous measurement levels.

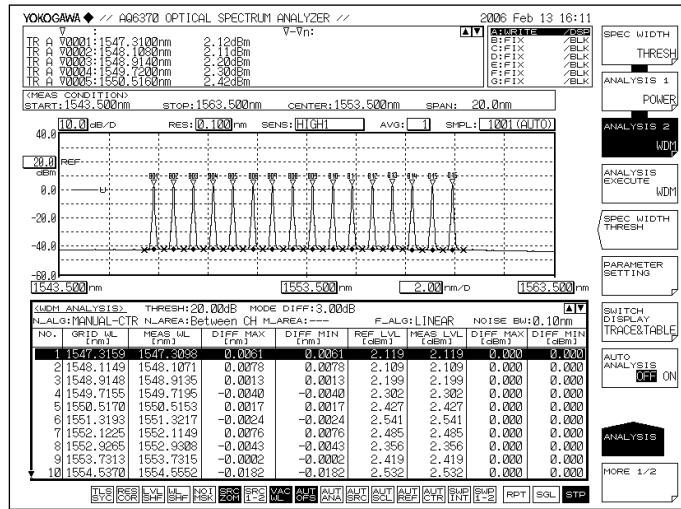

**Explanations of display items**

- NO: Channel number
- GRID WL: Reference wavelength of the channel (grid wavelength)
- MEAS WL: Center wavelength of the channel
- DIFF MAX (wavelength): Maximum value of the relative wavelength to the reference wavelength of the channel
- DIFF MIN (wavelength): Minimum value of the relative wavelength to the reference wavelength of the channel
- REF LVL: Reference level of the channel (previous measurement level)
- MEAS WL: Measurement level of the channel
- DIFF MAX (level): Maximum value of the relative level to the reference level of the channel
- DIFF MIN (level): Minimum value of the relative level to the reference level of the channel

- Absolute values and reference values to the GRID table are displayed. The GRID table can be freely configured.
- Reference wavelengths/levels can be changed under the following conditions:
  - When MAX/MIN RESET is set by the parameter, reset is performed by the active trace waveform data.
  - Reset is performed by the first waveform data that was measured when wavelength axes (SPAN WL/START WL/STOP WL) were changed by measurement conditions.

# Appendix 5 Details of Optical Amplifier Analysis Function

This function enables the analysis of gains and NF (noise figures) of optical fiber amplifiers.

## Items to be analyzed

- $\lambda_i$  Center wavelength of each channel. -> Center frequency during the frequency mode.
- LIN<sub>i</sub> Signal optical power of each channel (after OFFSET compensation)
- LOUT<sub>i</sub> Output optical power of each channel (after OFFSET compensation)
- LASE<sub>i</sub> ASE power of each channel (after OFFSET compensation)
- R<sub>bi</sub> Measurement resolution of each channel
- G<sub>i</sub> Gain of each channel
- N<sub>fi</sub> NF of each channel

## List of parameters

### Related to channel detection

Parameter	Default	Setting Range	Unit	Description
THRESH	20.0	0.1 to 99.9	dB	Threshold value for channel detection.
MODE DIFF	3.0	0.0 to 50.0	dB	Minimum value of the peak/bottom difference during channel detection
OFFSET(IN)	0.00	-99.99 to 99.99	dB	Level offset value of signal optical power.
OFFSET(OUT)	0.00	-99.99 to 99.99	dB	Level offset value of output optical power.
ASE ALGO	AUTO-FIX	AUTO-FIX MANUAL-FIX AUTO-CTR MANUAL-CTR	-	Selection of the algorithm for ASE level measurement.
FIT AREA	0.40nm	0.01 to 10.00nm	nm	A range of waveform data for use in ASE level analysis is specified as a range centering on channel wavelengths. When A_ALGO is <ul style="list-style-type: none"> <li>• AUTO-FIX: "AUTO"</li> <li>• MANUAL-FIX: ** **</li> <li>• AUTO-CTR: "Between Ch"</li> <li>• MANUAL-CTR: "Between Ch"</li> </ul>
MASK AREA	0.20nm	0.01 to 10.00nm	nm	Of the waveform data, specify the signal optical spectrum range for masking, which centers on the channel wavelength. When A_ALGO is <ul style="list-style-type: none"> <li>• AUTO-FIX: "-"</li> <li>• MANUAL-FIX <ul style="list-style-type: none"> <li>When F_ALGO is LINEAR: "-"</li> <li>Other cases: input of parameter value.</li> </ul> </li> <li>• AUTO-CTR: "-"</li> <li>• MANUAL-CTR <ul style="list-style-type: none"> <li>When F_ALGO is LINEAR: "-"</li> <li>Other cases: input of parameter value.</li> </ul> </li> </ul> Apply the limiter during input to ensure FITTING AREA is MASK AREA or more.
FITTING ALGO	LINEAR	LINEAR GAUSS LORENZ 3RD POLY 4TH POLY 5TH POLY	-	Selection of the fitting algorithm for obtaining ASE levels
POINT DISPLAY	ON	ON / OFF	-	ON/OFF for the function to display data range used for fitting in the waveform window.

### Algorithm for analysis

- 1 Apply the WDM analysis to the signal optical waveform data of TRACE A to perform channel detection. Note, however, that the parameter DISPLAY MASK is not used.
- 2 Obtain the center wavelength  $\lambda_i$  of each channel and signal optical level  $LIN_i$  of TRACE A optical signal.
- 3 Obtain the output optical level  $LOUT_i$  of each channel from the output optical waveform data of TRACE B.
- 4 Obtain  $LIN_i$  and  $LOUT_i$ , which are generated by compensating OFFSET(IN,OUT) for signal optical level and output optical level, respectively.
- 5 According to the setting of the parameter ASE ALGO, determine fitting area and mask area for performing the ASE fitting.
- 6 Obtain the measurement resolution  $RBI$  of each channel from the waveform of TRACE A.
- 7 Remove the signal optical SE elements contained in the output optical spectrum in the following order and write the result into TRACE C.
  - Obtain levels (linear) on both sides of the channel of the fitting area that was obtained in 5.
  - Use the obtained levels on both sides to obtain the provisional ASE level  $LB_i$  via the linear interpolation.
  - Obtain  $LB_i$ , which is generated by compensating OFFSET(OUT) for the provisional ASE level  $LB_i$ .
  - Obtain the provisional gain  $G_i$  using the following equation.  

$$G_i = (LOUT_i - LB_i) / LIN_i$$
  - Multiply the TRACE A data (linear) by the provisional gain  $G_i$  and subtract the result from the TRACE B data (linear). Then, write the result into TRACE C.
- 8 In the TRACE C data (linear) generated in 7, perform a fitting according to the settings of the parameter FITTING ALGO and create the estimated ASE spectrum in TRACE C. The data for use in the fitting is from the range of the center wavelength of each channel  $\pm$  FIT AREA to the range of MASK AREA. Obtain the level at  $\lambda_i$  in TRACE C as the ASE level  $LASE_i$  (linear). Then, obtain  $LASE_i$ , which is generated by compensating OFFSET (OUT) for it.

Calculate gain G and NF (linear) from the following equations.

Gain G

$$G_i = (LOUT_i - LASE_i) / LIN_i$$

NF value (during the air wavelength mode)

$$NF_i = \frac{N(\lambda_i)^2}{h \times c^2} \times \frac{\lambda_i^3}{RBI} \times \frac{LASE_i}{G} \times \frac{1}{G}$$

NF value (during the vacuum wavelength mode)

$$NF_i = \frac{1}{h \times c^2} \times \frac{\lambda_i^3}{RBI} \times \frac{LASE_i}{G} \times \frac{1}{G}$$

$N(\lambda_i)$ : Refraction index of the air

C: Speed of light in the vacuum  $2.99792458 \times 10^8$  [m/s]

h: Planck's constant  $6.6260755 \times 10^{-34}$  [J\*s]

Perform LOG conversion for  $Nfi$ ,  $Gi$ , and  $LASE_i$ .

## Automatic Parameter Setting Function

The AQ6370 provides a fit area/mask area automatic setting function.

### AUTO-FIX

#### ASE algorithm

The fitting algorithm is LINEAR.

Since the algorithm is LINEAR, the mask area setting will not be required.

Obtain the left and right fit areas (NA\_Ri, NA\_Li) of each channel by using the number of detected channels as follows.

#### When the number of channels “n” is 1

Internally obtain the measurement resolution of trace B and the value of the noise measurement point NOISE AREA in accordance with the resolution, and obtain the fit areas from the following equations.

$$NA\_Ri = \lambda i + NOISE\ AREA$$

$$NA\_Li = \lambda i - NOISE\ AREA$$

#### When the number of channels “n” is 2 or more

Obtain the channel spacing (spacing of  $\lambda i$ ) of each channel. Set the minimum spacing to SPACING and also use the following to obtain the NOISE AREA.

$$NA\_Ri = \lambda i + NOISE\ AREA \quad (i = 1, 2, \dots, n)$$

$$NA\_Li = \lambda i - NOISE\ AREA \quad (i = 1, 2, \dots, n)$$

### AUTO-CTR

#### ASE algorithm

The fitting algorithm is LINEAR.

Since the algorithm is LINEAR, the mask area setting will not be required.

Obtain the left and right fit areas (NA\_Ri, NA\_Li) of each channel by using the number of detected channels as follows (center points between channels are treated as NA\_Ri, NA\_Li.)

#### When the number of channels “n” is 1

Internally obtain the measurement resolution of trace B and the value of the noise measurement point NOISE AREA in accordance with the resolution, and obtain the fit areas from the following equations.

$$NA\_Ri = \lambda i + NOISE\ AREA$$

$$NA\_Li = \lambda i - NOISE\ AREA$$

#### When the number of channels “n” is 2 or more

$$\lambda N1 = (3\lambda_1 - \lambda_2)/2$$

$i=2, 3, \dots, n$

$$\lambda Ni = (\lambda_i + \lambda_{i-1})/2$$

$$\lambda Nn+1 = (3\lambda_n - \lambda_{n-1})/2$$

Perform the calculations.

$i=1, 2, \dots, n$

$$NA\_Li = \lambda Ni$$

$$NA\_Ri = \lambda Ni+1$$

---

## Appendix 6      Details of Optical Filter Analysis Function

### **FILTER PEAK Analysis Function**

This function enables the collective analysis of measured waveforms of optical filters via multiple parameters.

It can be used for filter analysis only if the number of modes is one. Items and algorithms for analysis are the same as in the AQ6317 series.

#### **Items for analysis**

PEAK LVL:	Peak level
PEAK WL:	Peak wavelength
CENTER WL:	Center wavelength
SPECTRUM WIDTH:	Wavelength width at threshold value TH
RIPPLE WIDTH:	Ripple width
CROSS TALK:	Cross talk

## List of Parameters

Item	Parameter	Default	Setting Range	Unit	Description
PEAK LEVEL	SW	ON	ON or OFF	-	ON/OFF switchover of display.
PEAL WL	SW	ON	ON or OFF	-	ON/OFF switchover of display.
CENTER WL	SW	ON	ON or OFF	-	ON/OFF switchover of display
	ALGO	THRESH	THRESH RMS	-	Selection of algorithm for spectrum width.
	THRESH LVL	THRESH : 3.00 RMS : 3.00	0.1 to 50.0	dB	Threshold value for channel detection. Valid only when ALGO is THRESH.
	K	THRESH : 1.00 RMS : -	1.00 to 10.00	-	Multiplying factor. Valid only when ALGO is THRESH.
	MODE FIT	THRESH : OFF RMS : -	ON or OFF	-	Whether "half of maximum point" is set to the mode peak or not. Valid only when ALGO is THRESH.
	MODE DIFF	THRESH : 3.00 RMS : -	0.0 to 50.0	dB	Minimum value of the peak/bottom difference during channel detection. Valid only when ALGO is THRESH.
SPECTRUM WIDTH	SW	ON	ON or OFF	-	ON/OFF switchover of display.
	ALGO	THRESH	THRESH RMS	-	Selection of algorithm for spectrum width.
	THRESH LVL	THRESH : 3.00 RMS : 3.00	0.1 to 50.0	dB	Threshold for channel detection.
	K	THRESH : 1.00 RMS : -	1.00 to 10.00	-	Multiplying factor. Valid only when ALGO is THRESH.
	MODE FIT	THRESH : OFF RMS : -	ON or OFF	-	Whether "half of maximum point" is set to the mode peak or not. Valid only when ALGO is THRESH.
SPECTRUM WIDTH	MODE DIFF	THRESH : 3.00 RMS : -	0.0 to 50.0	dB	Minimum value of the peak/bottom difference during channel detection. Valid only when ALGO is THRESH.
RIPPLE WIDTH	SW	ON	ON or OFF	-	ON/OFF switchover of display.
	THRESH LVL	3	0.1 to 50.0	dB	Threshold value for channel detection.
	MODE DIFF	0.5	0.000 to 50.000	dB	Minimum value of the peak/bottom difference during channel detection.
CROSS TALK	SW	ON	ON or OFF	-	ON/OFF switchover of display.
	ALGO	THRESH	THRESH PK LVL GRID	-	Selection of algorithm for spectrum width.
	THRESH LVL	THRESH : 3.00 PK LVL : - GRID : -	0.1 to 50.0	dB	Threshold value for channel detection. Valid only when ALGO is THRESH.
	K	THRESH : 1.00 PK LVL : - GRID : -	1.00 to 10.00	-	Multiplying factor. Valid only when ALGO is THRESH.
	MODE FIT	THRESH : OFF PK LVL : - GRID : -	ON or OFF	-	Whether "half of maximum point" is set to the mode peak or not. Valid only when ALGO is THRESH.
	MODE DIFF	THRESH : 3.00 PK LVL : - GRID : -	0.0 to 50.0	-	Minimum value of the peak/bottom difference during channel detection. Valid only when ALGO is THRESH.
	CH SPACE	0.4	0.00 to 50.00	nm	Setting of channel spacing
	SEARCH AREA	0.01	0.01 to 10.00	nm	Setting of the analysis range. Valid only when ALGO is GRID.

Details of Analyses

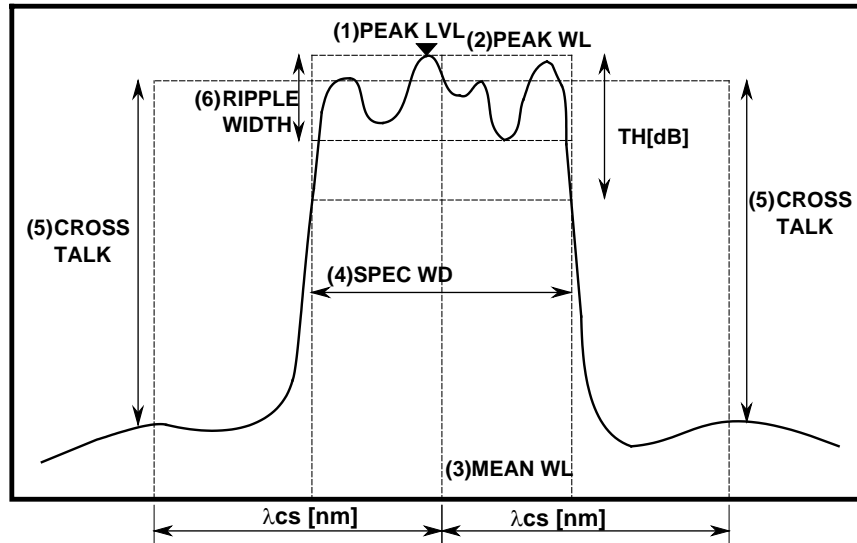

- (1) Peak level (PEAK LVL): value of the level at the waveform peak position
- (2) Peak wavelength (PEAK WL): value of the wavelength at the waveform peak position
- (3) Center wavelength (MEAN WL): value of the center wavelength at the threshold value TH
- (4) Spectrum width (SPEC WD): spectrum width at the threshold value TH
- (5) Cross talk (CRS TALK)

In the case of THRESH / PEAK LV algorithms

Obtain the value of the level on the reference wavelength (MEAN WL for THRESH and PEAK WL for PEAK LV). Also, obtain the value of the level at the wavelength which is  $\pm\lambda_{CH\ SPACE}$  away from the reference wavelength. Then, set the difference in level value between the two to the cross talk.

In the case of ITU-T algorithms

Set the ITU-T grid wavelength, which is nearest to the peak wavelength, to the reference wavelength. Set the difference between the bottom level within the range of the reference wavelength  $\pm\lambda_{SEARCH\ AREA}$  and the peak level within the range of the position  $\pm\lambda_{CH\ SPACE}$  away from the reference wavelength  $\pm\lambda_{SEARCH\ AREA}$  to the cross talk.

- (6) Ripple width (RIPPLE WD): Perform a spectrum width search. Set the value of the peak level – bottom level within the obtained spectrum width to the ripple width.

**Note**

- Unless the parameter "MODE DIFF" is set to a value smaller than uneven portions of a waveform regarded as a ripple, RIPPLE = 0 will result.
- RIPPLE = 0 if the parameter setting is "THRESH" < "MODE DIFF"

### FILTER BOTTOM Analysis Function

This function enables the collective analysis of multiple parameters via the measured waveforms of optical filters.

It is used for filter analysis if the number of modes is one. Items and algorithms for analysis are the same as in the AQ6317 series.

#### Items for analysis

- BOTTOM LVL: Bottom level
- BOTTOM WL: Bottom wavelength
- CENTER WL: Center wavelength
- NOTCH WIDTH: Notch width
- CROSS TALK: Cross talk

#### List of parameters

Item	Parameter	Default	Setting Range	Unit	Description
BOTTOM LEVEL	SW	ON	ON or OFF	-	ON/OFF switchover of display.
BOTTOM WL	SW	ON	ON or OFF	-	ON/OFF switchover of display.
CENTER WL	SW	ON	ON or OFF	-	ON/OFF switchover of display.
	ALGO	BOTTOM	PEAK BOTTOM	-	Selection of algorithm for spectrum width.
	THRESH LVL	3	0.1 to 50.0	dB	Threshold value for channel detection.
	MODE DIFF	3	0.0 to 50.0	dB	Minimum value of the peak/bottom difference during channel detection.
NOTCH	SW	ON	ON or OFF	-	ON/OFF switchover of display.
WIDTH	ALGO	BOTTOM	PEAK BOTTOM	-	Selection of algorithm for spectrum width.
	THRESH LVL	3	0.1 to 50.0	dB	Threshold value for channel detection.
	MODE DIFF	3	0.0 to 50.0	dB	Minimum value of the peak/bottom difference during channel detection. Valid only when ALGO is THRESH.
CROSS TALK	SW	ON	ON or OFF	-	ON/OFF switchover of display.
	ALGO	BOTTOM	PEAK BOTTOM BOTTOM_LVL GRID	-	Selection of algorithm for spectrum width.
	THRESH LVL	3	0.1 to 50.0	dB	Threshold value for channel detection. Valid when ALGO is PEAK/BOTTOM.
	MODE DIFF	3	00 to 50.0	-	Multiplying factor. Valid only when ALGO is THRESH.
	CH SPACE	0.4	0.0 to 50.00	nm	Setting of channel spacing.
	SEARCH AREA	0.01	0.01 to 10.00	nm	Setting of the range of analysis. Valid only when ALGO is GRID.

Details of Analysis

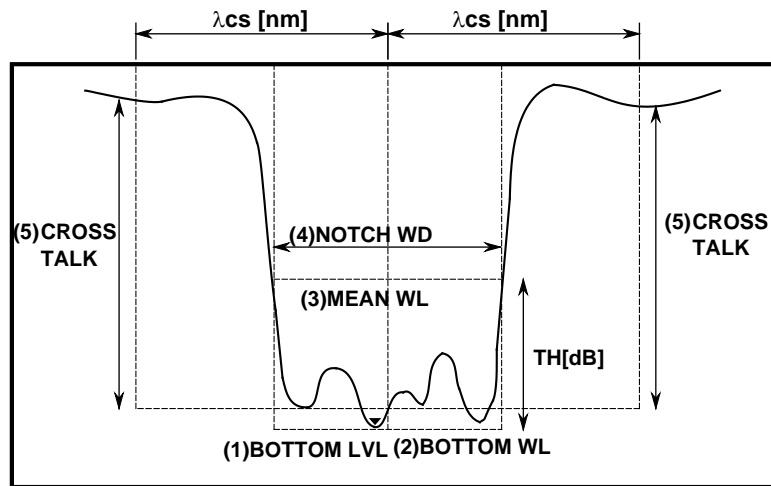

- (1) Bottom level (BTM LVL): Value of level at the waveform bottom position
- (2) Bottom wavelength (BTM WL): Value of wavelength at the waveform bottom position
- (3) Center wavelength (MEAN WL): Value of center wavelength at the threshold value TH
- (4) Notch width (NOTCH WD): Notch width at the threshold value TH
- (5) Cross talk (CRS TALK)

In the case of PEAK / BOTTOM / BOTTOM LV algorithms

Obtain the level value at the reference wavelength (MEAN WL for PEAK/BOTTOM, BOTTOM WL for BOTTOM LV). Also, obtain the level value at the wavelength which is  $\pm\lambda_{CH\ SPACE}$  away from the reference wavelength. Then, set the difference in level value between the two to the cross talk.

In the case of ITU-T algorithms

Set the ITU-T grid wavelength, which is nearest the bottom wavelength, to the reference wavelength. Set the difference between the peak level within the range of the reference wavelength  $\pm\lambda_{SEARCH\ AREA}$  and the bottom level within the range of the position  $\pm\lambda_{CH\ SPACE}$  away from the reference wavelength  $\pm\lambda_{SEARCH\ AREA}$  to the cross talk.

## WDM FILTER PEAK Analysis Function

This function enables the collective analysis of multiple items for each channel via the measured waveforms of multi-channel optical filters.

It also enables filter analysis for multi-mode waveforms, which is different from FILTER PEAK analysis.

### Items for analysis

Item for Analysis	Description
Nominal Wavelength	Reference wavelength/frequency of each channel.
Peak Wavelength / Level	Peak wavelength/frequency and level of each channel.
xdB Width / Center Wavelength	xdB width of each channel and its center wavelength/frequency.
xdB stop-band	Wavelength width/frequency width across xdB of each channel.
xdB pass-band	Pass band xdB from the bottom within the test band of each channel.
Ripple	Max-min level (flatness) within the test band of each channel.
Cross Talk	Difference in level from the position xnm away from each channel.

### List of Parameters

Item	Parameter	Default	Setting Range	Unit
Channel Detection, Nominal Wavelength	ALGORHYTHM	MEAN	PEAK / MEAN / GRID/ GRID FIT	-
	MODE DIFF	3	0.1 to 50.0	dB
	THRESH	20	0.1 to 99.9	dB
	TEST BAND	0.1	0.001 to 9.999	nm
Peak Wavelength/ Level	SW	ON	ON / OFF	-
XdB Width	SW	ON	ON / OFF	-
Center Wavelength	THRESH	3	0.1 to 50.0	dB
XdB stop-band	SW	ON	ON / OFF	-
	THRESH LVL	-10	-90.00 to 30.00	dB
XdB pass-band	SW	ON	ON / OFF	-
	THRESH	3.0	0.1 to 50.0	dB
	TEST BAND	0.20 / 25.0	0.01 to 99.99 / 1.0 to 999.9	nm / GHz
Ripple	SW	ON	ON / OFF	-
	TEST BAND	0.20 / 25.0	0.01 to 99.99 / 1.0 to 999.9	nm / GHz
Cross Talk	SW	ON	ON / OFF	-
	SPACING	0.80 / 100.0	0.01 to 99.99 / 1.0 to 999.9	nm / GHz
	TEST BAND	0.20 / 25.0	0.01 to 99.99 / 1.0 to 999.9	nm / GHz

## Algorithms for analysis

### Channel Detection, Nominal Wavelength

#### Parameter

THRESH  
MODE DIFF  
ALGO  
TEST BAND

#### Procedure

##### PEAK

- Channel: Each mode peak detected via a mode search (Except for the mode peaks at levels which are lower than the mode at the highest level by THRESH[dB] or less.)
- Reference wavelength: Wavelength of each mode peak.
- Peak wavelength/level: Wavelength and level of each mode peak.

##### MEAN

- Channel: Each mode peak detected via a mode search (Except for the mode peaks at levels which are lower than the mode at the highest level by THRESH[dB] or less.)
- Reference wavelength: 3 dB center wavelength at each mode peak.
- Peak wavelength/level: Wavelength and level of each mode peak.

##### GRID FIT

- Channel: Modes within the range of GRID wavelength  $\pm$  (TEST BAND/2) among the mode peaks detected via a mode search (except for the mode peaks at levels which are lower than the mode at the highest level by THRESH[dB] or less).  
If the number of relevant modes in one GRID is more than one, only the mode at the highest level will be regarded as the channel.
- Reference wavelength: GRID wavelength nearest to each channel.
- Peak wavelength/level: Wavelength and level of the mode peak of each channel.

##### GRID

- Channel: A mode search shall not be performed. All GRID wavelengths within the range of analysis shall be the channels.
- Reference wavelength: GRID wavelength of each channel.
- Peak wavelength/level: Peak wavelength and peak level within the range of GRID wavelength  $\pm$  (TEST BAND/2) of each channel.

**PEAK LVL/PEAK WL**

Parameter

THRESH

MODE DIFF

Procedure

- Apply WDM analysis to the waveform data of an active trace and perform channel detection. Note that the parameter DISPLAY MASK is not used.
- Obtain the mode peak wavelength (PEAK WL) of each channel of the active trace and its signal optical level (PEAK LVL).

**XdB Width**

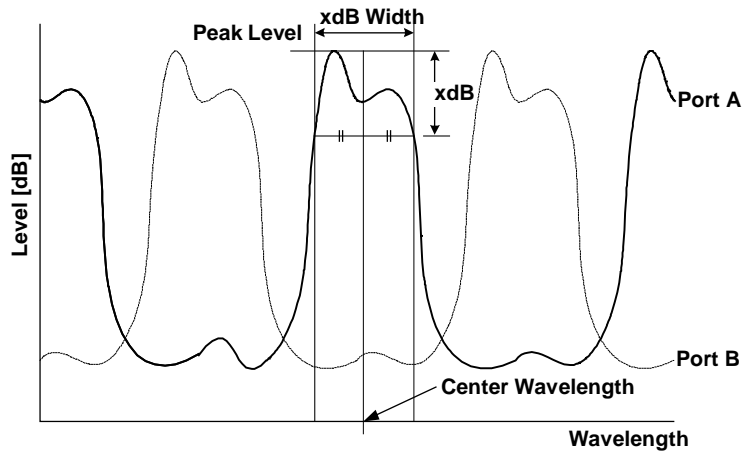

Parameter

THRESH

Procedure

Obtain the width (xdB\_Width), which is below the peak level LPi of each channel by the parameter THRESH\_LEVEL both on the left and on the right, and its center wavelength. The algorithm for analysis is the same as the algorithm THRESH of the spectrum width.

**XdB stop band**

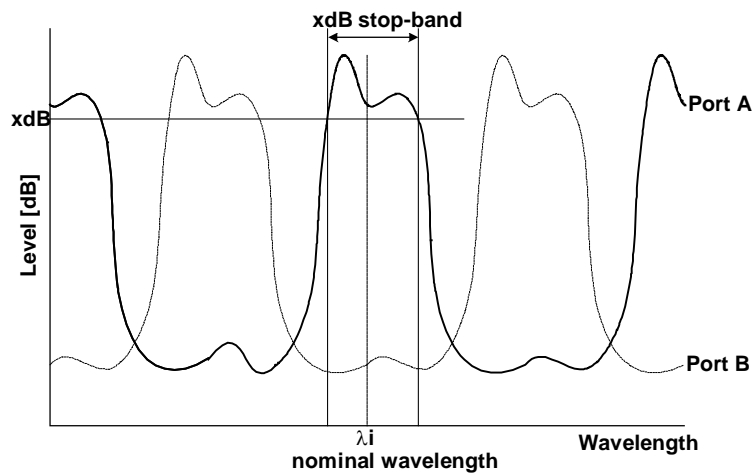

Parameter  
THRESH

Procedure  
Obtain the width (xdB\_stop-band) that centers on the reference wavelength  $\lambda_i$  of each channel and that is located below by the parameter THRESH\_LEVEL both on the left and on the right.

**XdB pass-band**

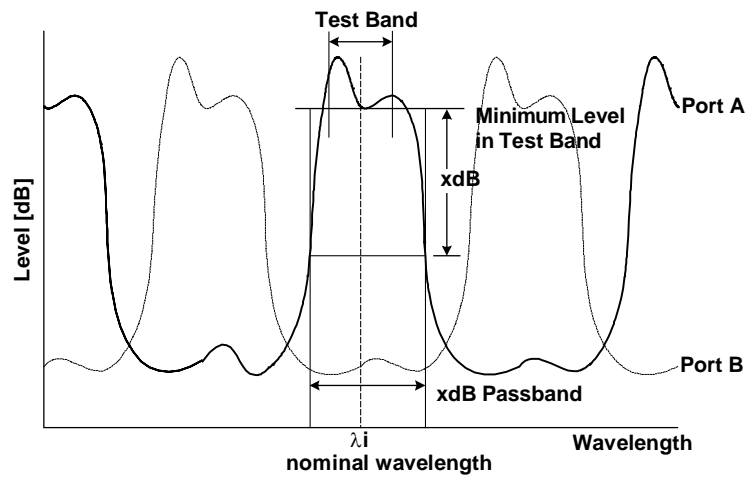

Parameter  
THRESH  
TEST BAND

Procedure

- Perform the bottom search within the range of parameter Test\_Band/2 by centering on reference wavelength  $\lambda_i$  of each channel and obtain the bottom level (L<sub>Bi</sub>).
- Obtain the width (xdB\_pass-band) that is below the bottom level L<sub>Bi</sub> obtained in the above procedure by the parameter THRESH\_LEVEL.

## Ripple

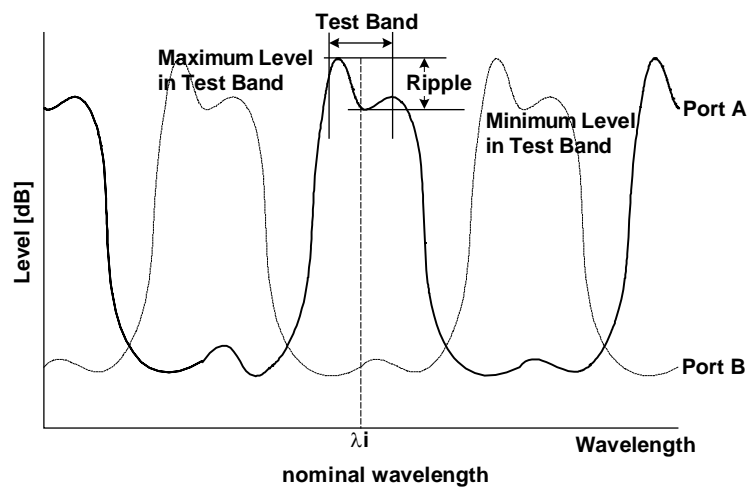

## Parameter

TEST BAND

## Procedure

- Perform the peak search and bottom search within the range of parameter Test\_Band/2 by centering on the reference wavelength  $\lambda_i$  of each channel, and obtain the peak level (LP'i) and the bottom level (LB'i).
- Use the peak level (LP'i) and bottom level (LB'i) obtained in the above procedure to obtain the ripple from the following equation:

$$\text{Ripple} = \text{LP}'i - \text{LB}'i$$

Cross Talk

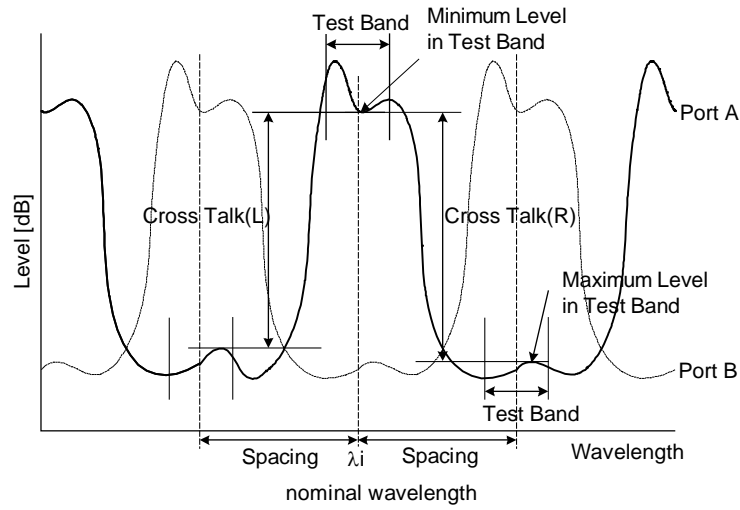

Parameter

- SPACING
- TEST BAND

Procedure

- Perform a bottom search within the range of parameter Test\_Band/2 while centering on reference wavelength ( $\lambda_i$ ) of each channel and obtain the bottom level (LBi).
- Perform a peak search within the range of parameter Test\_Band/2 while centering on the point ( $\lambda_i - \lambda \cdot SP$ ) that is obtained by subtracting the parameter SPACING from the reference wavelength  $\lambda_i$  of each channel. Then, obtain the peak level (LPLi).
- Perform a peak search within the range of parameter Test\_Band/2 while centering on the point ( $\lambda_i + \lambda \cdot SP$ ) that is obtained by adding the parameter SPACING to the reference wavelength  $\lambda_i$  of each channel. Then, obtain the peak level (LPRi).
- Use the values obtained in the above procedure to obtain the left and right cross talks (XTLi, XTRi) of each channel from the following equations:

$$XTLi = Lbi - LPLi$$

$$XTRi = Lbi - LPRi$$

## WDM FILTER BOTTOM Analysis Function

This function enables the collective analysis of multiple items of each channel via the measured waveforms of multi-channel optical filters.

It also enables filter analysis for multi-mode waveforms, which is different from the FILTER BOTTOM analysis.

### Items for analysis

Item for Analysis	Description
Nominal Wavelength	Reference wavelength/frequency of each channel.
Bottom Wavelength / Level	Peak wavelength/frequency and level of each channel
xdB Notch Width / Center Wavelength	xdB notch width of each channel and its center wavelength/frequency.
xdB stop-band	Wavelength width / frequency width across xdB of each channel.
xdB Elimination band	Elimination band that is xdB from the bottom within the test band of each channel.
6Ripple	Max-min level (flatness) within the test band of each channel.
Cross Talk	Difference in level between the positions that are xnm away in each channel.

### List of Parameters

Item	Parameter	Default	Setting Range	Unit
Channel Detection, Nominal Wavelength	ALGORHYTHM	NOTCH(B)	PEAK / NOTCH(P)/ NOTCH(B) / GRID / GRID FIT	-
	MODE DIFF	3.0	0.1 to 50.0	dB
	THRESH	20.0	0.1 to 99.9	dB
	TEST BAND	0.100	0.001 to 9.999	nm
Bottom Wavelength/Level	SW	ON	ON / OFF	-
XdB Width Center Wavelength	SW	ON	ON / OFF	-
	ALGORHYTHM	NOTCH(B)	NOTCH(P) / NOTCH(B)	-
	THRESH	3.0	0.1 to 50.0	dB
XdB stop-band	SW	ON	ON / OFF	-
	THRESH	-10.000	-90.000 to 30.000	dB
XdB Elimination band	SW	ON	ON / OFF	-
	THRESH	3.0	0.1 to 50.0	dB
	TEST BAND	0.20 / 25.0	0.01 to 99.99 / 1.0 to 999.9	nm / GHz
Ripple	SW	ON	ON / OFF	-
	TEST BAND	0.20 / 25.0	0.01 to 99.99 / 1.0 to 999.9	nm / GHz
Cross Talk	SW	ON	ON / OFF	-
	SPACING	0.80 / 100.0	0.01 to 99.99 / 1.0 to 999.9	nm / GHz
	TEST BAND	0.20 / 25.0	0.01 to 99.99 / 1.0 to 999.9	nm / GHz

**Algorithm for analysis**

**NOMINAL WAVELENGTH**

Parameter

- ALGO
- MODE DIFF
- THRESH
- TEST BAND

Procedure

- **BOTTOM**

Channel: Each mode bottom detected by a mode search (Except for the mode bottoms at levels which are above the mode at the lowest level by THRESH[dB] or more.)

Reference wavelength: Wavelength of each mode bottom.

Bottom wavelength/level: Wavelength/level of each mode bottom.

- **NOTCH(B)**

Channel: Each mode bottom detected by a mode search (Except for the mode bottoms at levels which are above the mode at the lowest level by THRESH[dB] or more.)

Reference wavelength: 3dB-center wavelength with each mode bottom as the reference (ALGO=BOTTOM).

Bottom wavelength/level: Wavelength and level of each mode peak.

- **NOTCH(P)**

Channel: Each mode peak detected by a mode search (Except for the mode bottoms at levels which are above the mode at the lowest level by THRESH[dB] or more.)

Reference wavelength: 3dB-center wavelength with each mode bottom as the reference (ALGO=PEAK).

Bottom wavelength/level: Wavelength and level of each mode bottom.

- **GRID FIT**

Channel: Modes within the range of GRID wavelength  $\pm$  (TEST BAND/2) among the mode bottoms detected via a mode search (except for the mode bottoms at levels which are higher than the mode at the lowest level by THRESH[dB] or more).  
If the number of relevant modes in one GRID is more than one, only the mode at the lowest level will be regarded as the channel.

Reference wavelength: GRID wavelength nearest to each channel.

Bottom wavelength/level: Wavelength and level of the mode bottom of each channel.

- **GRID**

Channel: A mode search shall not be performed. All the GRID wavelengths within the range of analysis shall be the channels.

Reference wavelength: GRID wavelength of each channel.

Peak wavelength/level: Bottom wavelength and bottom level within the range of GRID wavelength  $\pm$  (TEST BAND/2) of each channel.

**BOTTOM WL / BOTTOM LVL**

Parameter  
 THRESH  
 MODE DIFF

Procedure  
 Obtain the wavelength  $\lambda_i$  of the mode bottom of each channel and its signal optical level  $L_{Bi}$ .

**XdB\_NOTCH\_WIDTH/CENTER WAVELENGTH**

Parameter  
 ALGO

Procedure  
 According to the settings of the parameter ALGO, obtain the xdB notch width ( $x_{dB\_Notch\_Width}$ ) of each channel and its center wavelength/frequency ( $Center\_Wavelength$ ).

**NOTCH(B)**

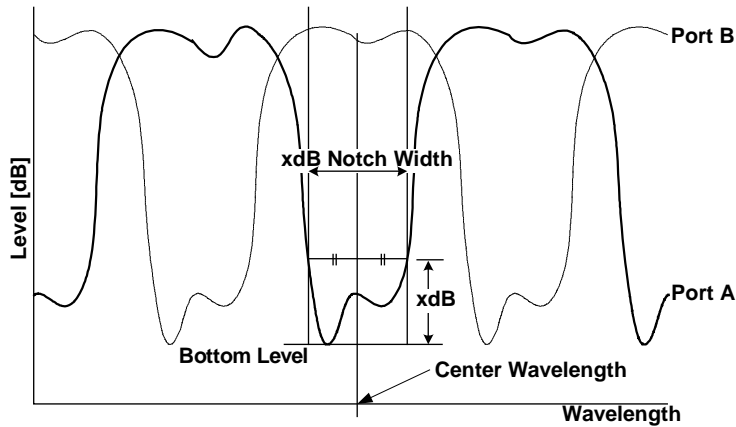

Obtain the width ( $x_{dB\_Notch\_Width}$ ) between the two points, which are above the bottom level of each channel by the parameter THRESH\_LEVEL, and its center wavelength ( $Center\_Wavelength$ ).

**NOTCH(P)**

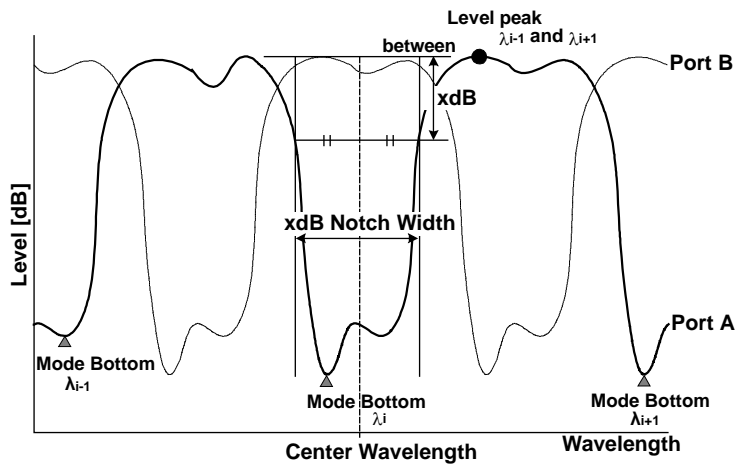

Obtain the width ( $x_{dB\_Notch\_Width}$ ) between the two points, which are below the higher point of either the left peak level or the right peak level of each channel by the parameter THRESH\_LEVEL, and its center wavelength/frequency ( $Center\_Wavelength$ ).

**XdB\_STOP-BAND**

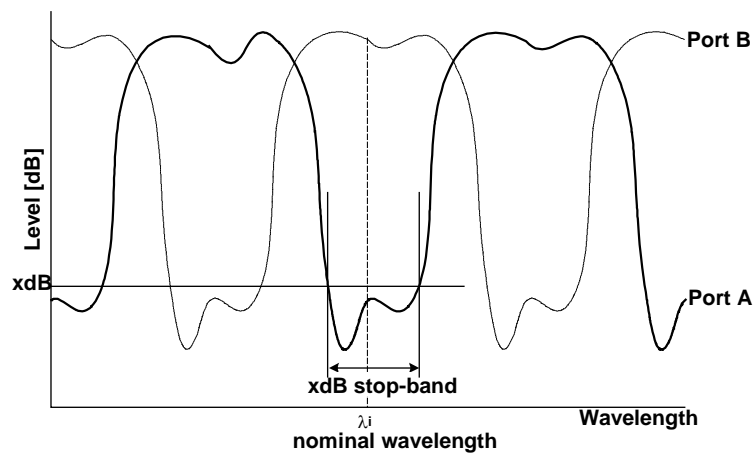

Parameter  
THRESH

Procedure  
Obtain the width (xdB\_stop-Band) that centers on the nominal wavelength  $\lambda_i$  of each channel and that is located below by the parameter THRESH\_LEVEL both on the left and on the right.

**XdB\_ELIMINATION BAND**

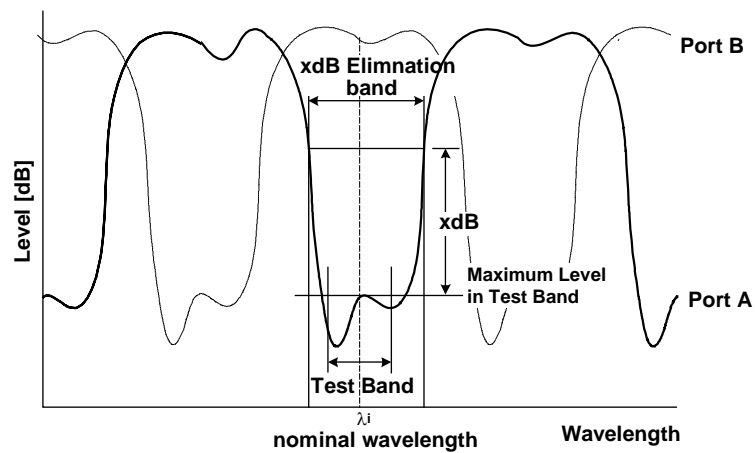

Parameter  
THRESH  
TEST BAND

Procedure

- Perform the peak search within the range of the parameter Test\_Band/2 by centering on the nominal wavelength  $\lambda_i$  of a channel and obtain the peak level (LPi).
- Obtain the width (xdB\_Elimination\_Wavelength) that is above the peak level LPi obtained in the above procedure by the parameter THRESH\_LEVEL both on the left and on the right.

## RIPPLE

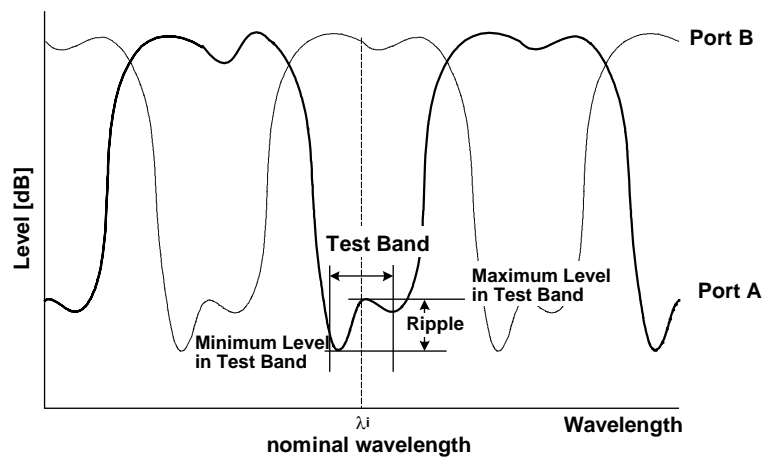

Parameter

TEST BAND

Procedure

- Perform the peak search and bottom search within the range of parameter Test\_Band/2 by centering on reference wavelength  $\lambda_i$  of each channel, and obtain the peak level (LP'i) and the bottom level (LB'i).
- Use the peak level (LP'i) and bottom level (LB'i) obtained in the above procedure to obtain the ripple (Ripple) from the following equation:  
Ripple = LP'i - LB'i

**CROOS TALK**

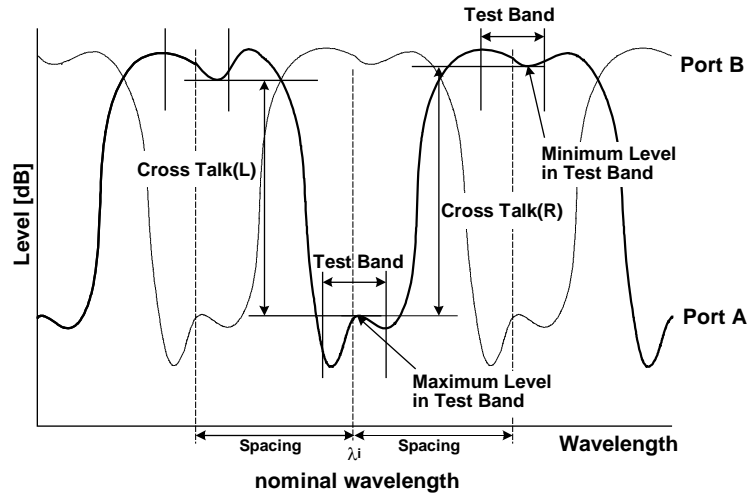

Parameter

SPACING

TEST BAND

Procedure

- Perform a peak search within the range of parameter Test\_Band/2 while centering on the reference wavelength  $\lambda_i$  of each channel and obtain the peak level (LP<sup>''i</sup>).
- Perform a bottom search within the range of parameter Test\_Band/2 while centering on the point  $(\lambda_i - \lambda \cdot SP)$  that is obtained by subtracting the parameter SPACING from the reference wavelength  $\lambda_i$  of each channel. Then, obtain the bottom level (LPLi).
- Perform the bottom search within the range of parameter Test\_Band/2 while centering on the point  $(\lambda_i + \lambda \cdot SP)$  that is obtained by subtracting the parameter SPACING from the reference wavelength  $\lambda_i$  of each channel. Then, obtain the bottom level (LPRi).
- Use the values obtained in the above procedures to obtain the left and right cross talks (XTLi, XTRi) of each channel from the following equations:

$$XTLi = LP''i - LPLi$$

$$XTRi = LP''i - LPRi$$

# Appendix 7 Soft Key Tree Diagram

The following is an overview of the instrument's menus. Some menus are omitted.

## SWEEP

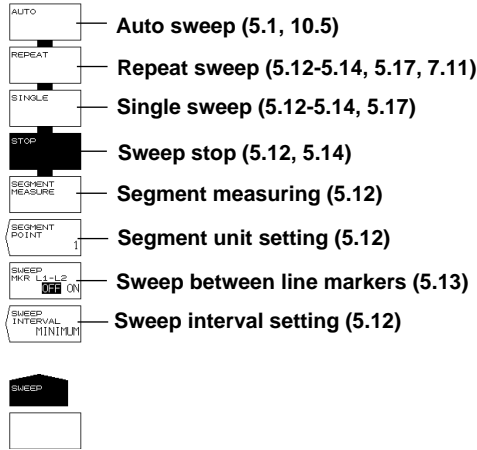

## CENTER

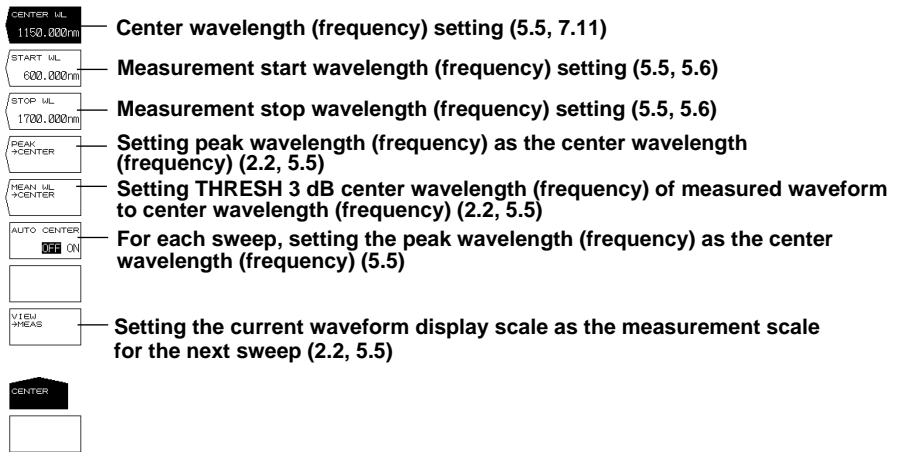

## SPAN

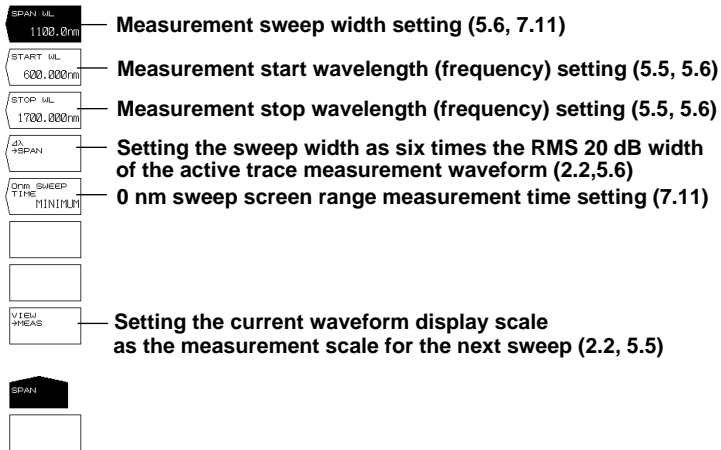

## LEVEL

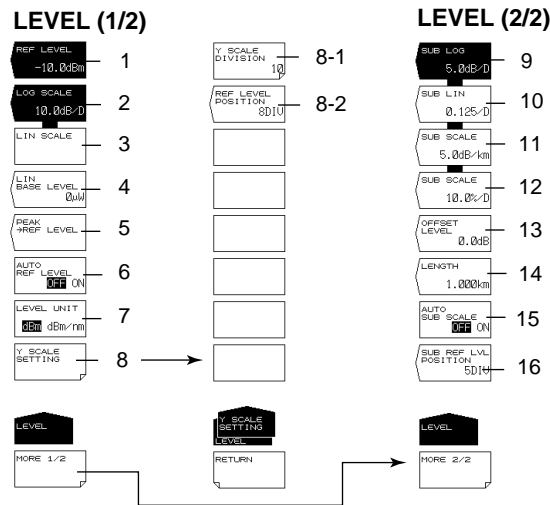

- 1 Reference level setting (2.5, 5.1, 5.4, 7.12)
- 2 LOG scale setting (5.2, 5.4)
- 3 Linear scale setting (5.2, 5.4)
- 4 Linear scale bottom settings (5.2)
- 5 Setting the peak level to the reference level (2.2, 5.4)
- 6 Automatic setting of reference level (5.4)
- 7 Vertical axis units setting (5.2)
- 8 Vertical axis setting (5.2)
  - 8-1 Setting the number of vertical axis divisions (5.2)
  - 8-2 Reference level screen position setting (5.2)
- 9 Setting subscale to LOG (5.3)
- 10 Setting subscale to LINEAR (5.3)
- 11 Setting subscale to dB/km (5.3)
- 12 Setting subscale to % (5.3)
- 13 Linear subscale bottom setting or offset level setting for LOG (5.3)
- 14 Optical fiber length setting (5.3)
- 15 Automatic scaling of subscale (5.3)
- 16 Position settings in the reference level subscale (5.3)

SETUP

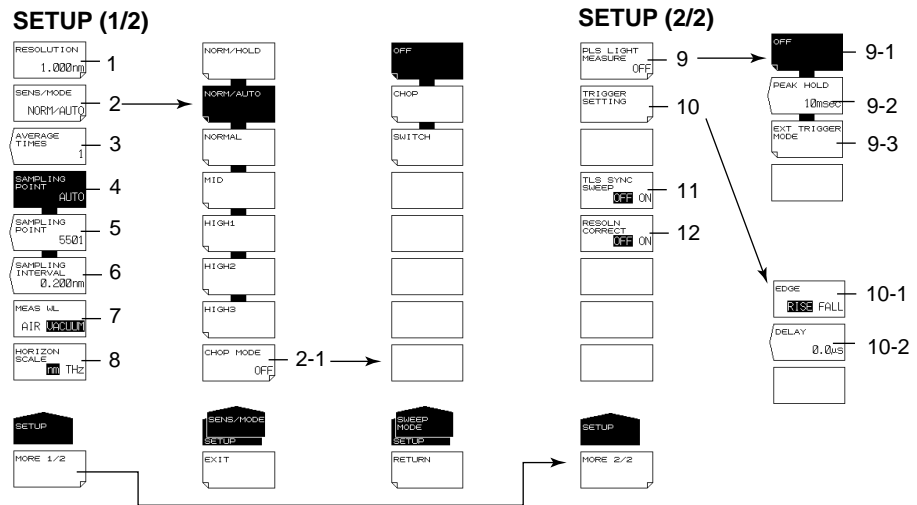

- 1 Measurement resolution setting (5.7, 7.11, 10.5)
- 2 Measurement sensitivity, CHOP mode settings (5.9)
  - 2.1 CHOP mode setting (5.9)
- 3 Averaging times setting (5.10)
- 4 Automatic sampling points setting (5.7, 5.8)
- 5 Manual sampling points setting (5.8)
- 6 Sampling interval setting (5.8)
- 7 Setting the measured wavelength to air/vacuum (5.2)
- 8 Horizontal axis units setting (5.2)
- 9 Pulse light measurement settings (5.14, 5.15)
  - 9-1 Pulse light measurement OFF (5.14)
  - 9-2 Peak hold time setting (5.14)
  - 9-3 External trigger mode setting (5.15)
- 10 Trigger condition settings (5.15)
  - 10-1 Edge setting (5.15)
  - 10-2 Delay setting (2.2, 5.15)
- 11 Synchronous sweep (5.15-5.17)
- 12 Resolution correction function ON/OFF (5.7)

## ZOOM

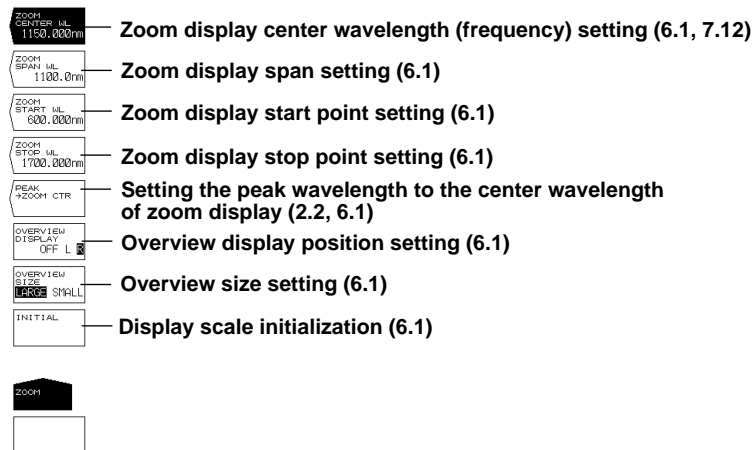

## DISPLAY

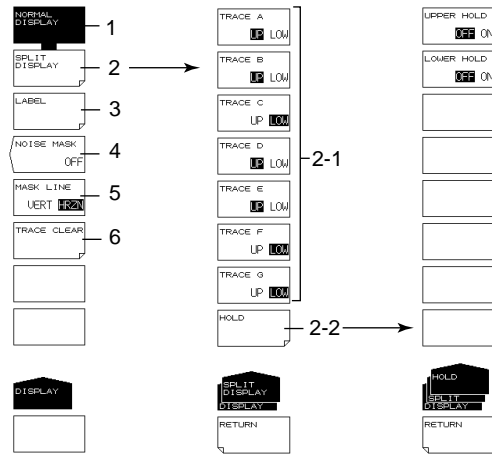

- 1 Normal display (6.9)
- 2 Split display (6.9)
  - 2-1 Display position setting
  - 2-2 Display position fixing
- 3 Label setting (4.3)
- 4 Noise mask setting (2.3, 6.10)
- 5 Mask method setting (6.10)
- 6 Trace clearing (6.11)

TRACE (MORE 1/2)

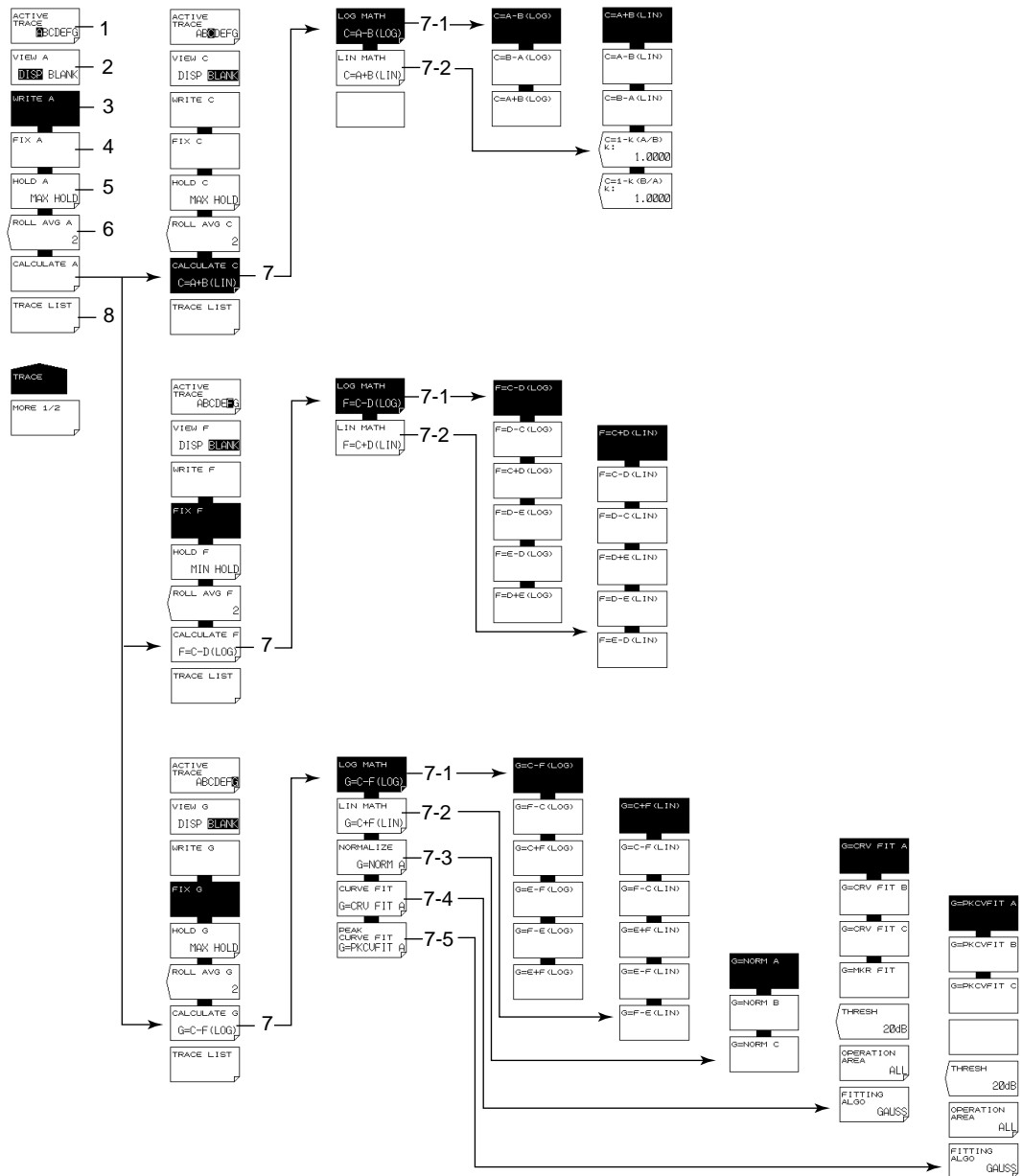

- 1 Active trace setting (5.11, 6.2-6.7, 7.8, 7.9)
- 2 Show/hide active trace setting (5.11, 6.2-6.7, 7.8, 7.9)
- 3 Setting write mode on the active trace (5.11, 6.2, 7.8, 7.9)
- 4 Setting fixed mode on the active trace (6.2, 7.8, 7.9)
- 5 Setting MAX/MIN hold mode on the active trace (6.3)
- 6 Active trace sweep average setting(6.4)
- 7 Trace-to-trace calculation settings (trace C, F, G only) (6.5-6.7, 7.9)
  - 7-1 LOG based between-trace calculation (6.5, 7.9)
  - 7-2 LIN based between-trace calculation (6.5)
  - 7-3 Trace normalization (trace G only) (6.5, 6.6)
  - 7-4 Trace curve fitting (trace G only) (6.5, 6.7)
  - 7-5 Trace peak curve fitting (trace G only) (6.5, 6.7)
- 8 Trace conditions list display (6.11)

TRACE(MORE 2/2)

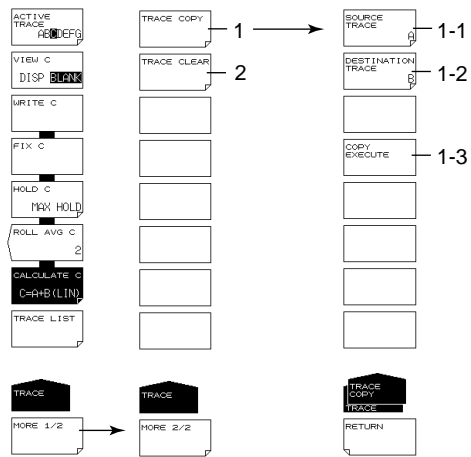

- 1 Copy trace (6.11)
  - 1-1 Copy source trace setting (6.11)
  - 1-2 Copy target trace setting (6.11)
  - 1-3 Execute copy (6.11)
- 2 Trace clearing (6.11)

## MARKER

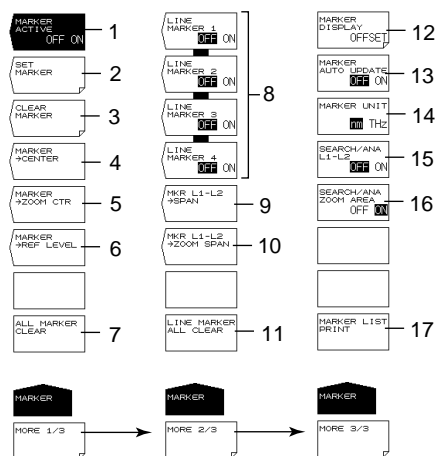

- 1 Moving marker display ON/OFF (6.8)
- 2 Setting moving markers to fixed markers (6.8, 6.12)
- 3 Clearing fixed markers (6.8, 6.12)
- 4 Setting the moving marker wavelength (frequency) to measurement center (2.2, 5.5, 6.8)
- 5 Setting the moving marker wavelength (frequency) to display scale center (2.2, 6.8)
- 6 Setting the moving marker level to reference level (2.2, 5.4, 6.8)
- 7 Clear all displayed moving and fixed markers (6.8, 6.12)
- 8 Line markers ON/OFF (6.8)
- 9 Setting the measurement span to between line markers 1 and 2 (2.2, 5.6, 6.8)
- 10 Setting the zoom span to between line markers 1 and 2 (2.2, 6.8)
- 11 Clear all displayed line markers (6.8)
- 12 Marker display settings (6.8)
- 13 Setting whether to automatically update the fixed marker's level values when updating active trace (6.8)
- 14 Marker value units setting (6.8, 7.10)
- 15 Setting the peak search, bottom search, and analysis function ranges to between line markers L1 and L2 (6.12, 7.13)  
(For both the PEAK SEARCH and ANALYSIS menus)
- 16 Setting the peak search, bottom search, and analysis function ranges to within the zoom range (6.12, 7.13)  
(For both the PEAK SEARCH and ANALYSIS menus)
- 17 Print out multi marker values (6.8)

## PEAK SEARCH

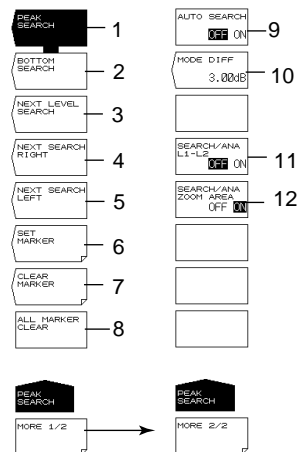

- 1 Executing peak search (6.12)
- 2 Executing bottom search (6.12)
- 3 Moving the moving marker from the current position to the next peak/bottom value (6.12)
- 4 Moving the moving marker from the current position to the next peak/bottom value to the right (6.12)
- 5 Moving the moving marker from the current position to the next peak/bottom value to the left (6.12)
- 6 Setting the moving marker to the fixed marker (6.8, 6.12)
- 7 Clearing fixed markers (6.8, 6.12)
- 8 Clearing all displayed moving and fixed markers (6.8, 6.12)
- 9 Turning ON/OFF peak/bottom search each sweep (6.12)
- 10 Setting the minimum peak/bottom difference of the mode judgment reference (6.12, 7.6, 7.8)
- 11 Setting the peak search, bottom search, and analysis function ranges to between line markers L1 and L2 (6.12, 7.13)  
(For both the MARKER and ANALYSIS menus)
- 12 Setting the peak search, bottom search, and analysis function ranges to within the zoom range (6.12, 7.13)  
(For both the MARKER and ANALYSIS menus)

## ANALYSIS

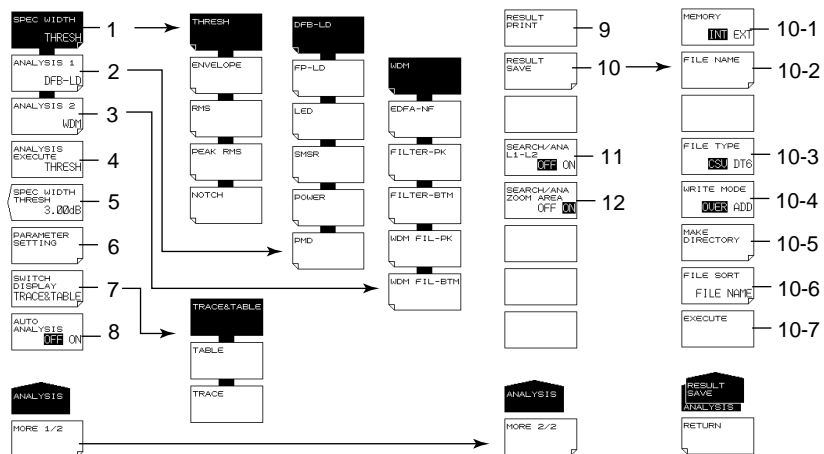

- 1 Spectrum width analysis algorithm settings/execution (7.1, 7.2)
- 2 Analysis function settings (7.3–7.6, 7.13)  
(DFB-LD, FP-LD, LED, SMSR, POWER, PMD)
- 3 Analysis function settings (7.7-7.9)  
(WDM, FILTER-PK, FILTER-BTM, WDM FIL-PK, WDM FIL-BTM)
- 4 Executing the specified analysis (chapter 7)
- 5 Spectrum width analysis threshold setting (7.1)
- 6 Analysis parameter settings (7.1-7.9)
- 7 Editing the ANALYSIS2 analysis results display screen (7.7-7.9)
- 8 Turning ON/OFF automatic analysis each sweep (7.1)
- 9 Printing analysis results (7.1)
- 10 Saving analysis results (7.1)
  - 10-1 Setting the save destination (8.5)
  - 10-2 Entering a file name (8.5)
  - 10-3 Setting the data format (8.5)
  - 10-4 Setting overwrite or add (8.5)
  - 10-5 Creating a directory (8.5)
  - 10-6 Sorting a file (8.5)
  - 10-7 Executing saving (8.5)
- 11 Setting the peak search, bottom search, and analysis function ranges to between line markers L1 and L2 (6.12, 7.13)  
(For both the MARKER and PEAK SEARCH menus)
- 12 Setting the peak search, bottom search, and analysis function ranges to within the zoom range (6.12, 7.13)  
(For both the MARKER and PEAK SEARCH menus)

# MEMORY

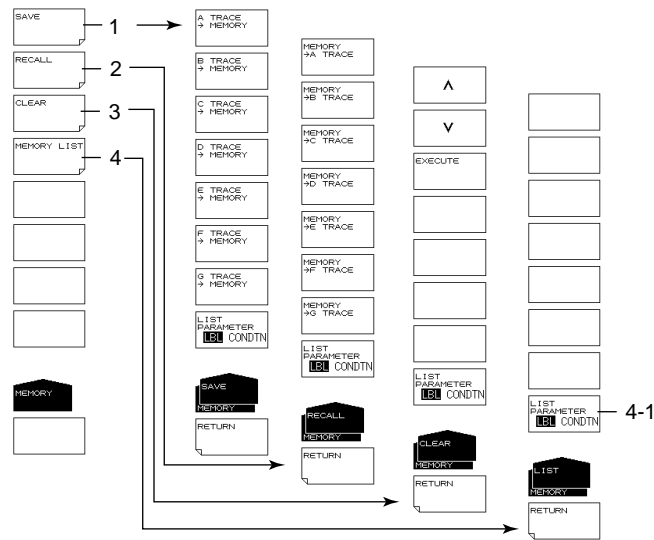

- 1 Temporarily saving a trace (8.2)
- 2 Loading temporarily saved trace (8.2)
- 3 Clearing temporarily saved traces (8.2)
- 4 Displaying temporarily saved traces in a list (8.2)
- 4-1 Changing list display contents (8.2)

FILE

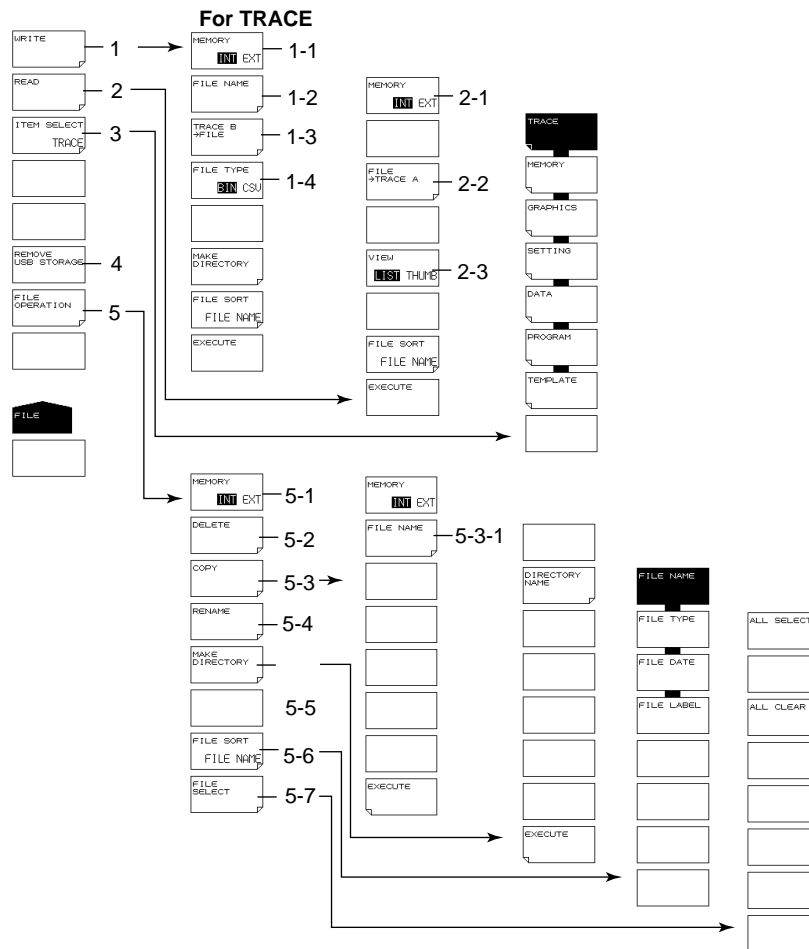

- 1 Saving data (chapter 8)
  - 1-1 Setting the save destination for trace data (8.3)
  - 1-2 Entering a file name (8.3)
  - 1-3 Setting the trace to save (8.3)
  - 1-4 Setting the data format (8.3)
- 2 Loading data (7.12, chapter 8)
  - 2-1 Setting the loading source for trace data (8.3)
  - 2-2 Setting the loading destination trace (8.3)
  - 2-3 Switching list/thumbnail display (8.3)
- 3 Setting the target item (7.12, chapter 8)
- 4 Removing the USB storage medium (3.3, 8.1)
- 5 File manipulation (8.9)
  - 5-1 Setting the target storage device (8.9)
  - 5-2 Deleting a file (8.9)
  - 5-3 Copying a file (8.9)
    - 5-3-1 Setting the paste destination (8.9)
    - 5-3-2 File name when saving to separate name (8.9)
  - 5-4 Renaming (8.9)
  - 5-5 Creating a directory (8.9)
  - 5-6 Sorting a file (8.9)
  - 5-7 File selection (8.9)

**For MEMORY**

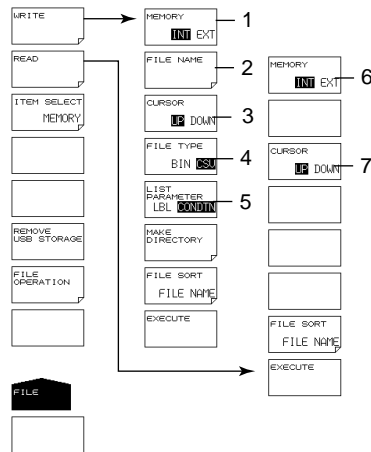

**MEMORY**

- 1 Setting the MEMORY data save destination (8.3)
- 2 Entering a file name (8.3)
- 3 Switching the cursor target window (8.3)  
(setting the source/destination memory number)
- 4 Setting the data format (8.3)
- 5 Switching the MEMORY list display contents (8.3)
- 6 Setting the MEMORY data loading source (8.3)
- 7 Switching the cursor target window (8.3)  
(setting the source/destination load file)

**For SETTING**

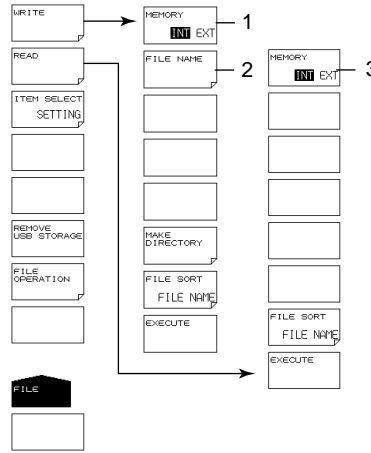

**SETTING**

- 1 Setting the save destination for settings (8.4)
- 2 Entering a file name (8.4)
- 3 Setting the loading source for settings (8.4)

**For DATA**

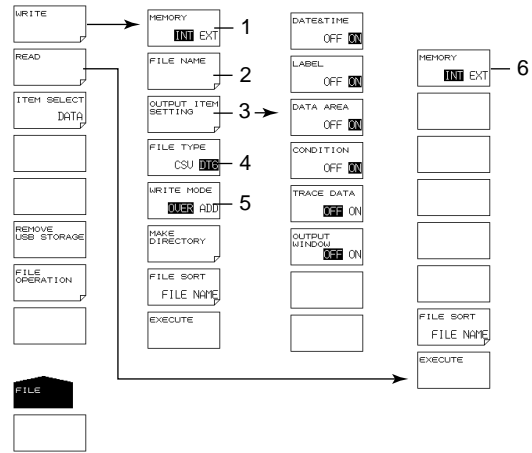

**DATA**

- 1 Setting the save destination for analysis results data (8.5)
- 2 Entering a file name (8.5)
- 3 Setting the items to save (8.5)
- 4 Data format setting (8.5)
- 5 Setting overwrite or add (8.5)
- 6 Setting the loading source for analysis results data (8.5)

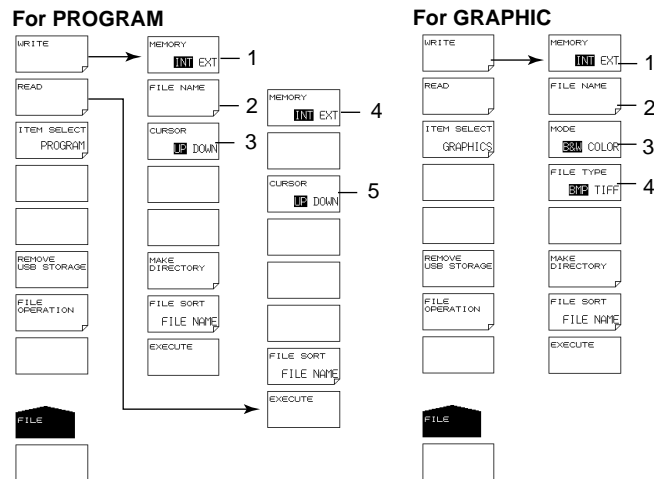

**PROGRAM**

- 1 Setting the save destination for program data (8.6)
- 2 Entering a file name (8.6)
- 3 Switching the cursor target window (8.6)  
(setting the source/destination program number)
- 4 Setting the loading source for program data (8.6)
- 5 Switching the cursor target window (8.6)  
(setting the source/destination load file)

**GRAPHIC**

- 1 Setting the save destination for image data (8.7)
- 2 Entering a file name (8.7)
- 3 Color mode setting (8.7)
- 4 Data format setting (8.7)

**For TEMPLATE**

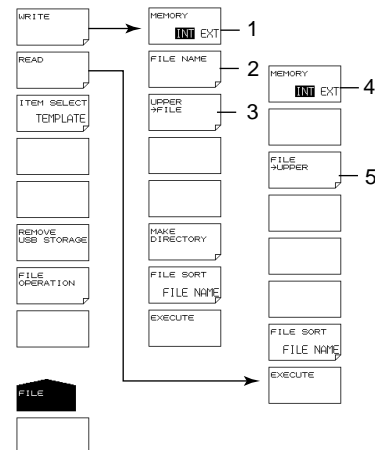

**TEMPLATE**

- 1 Setting the save destination for template data (8.8)
- 2 Entering a file name (8.8)
- 3 Setting a template to save (8.8)
- 4 Setting the loading source for template data (8.8)
- 5 Setting the loading destination for template data (7.12, 8.8)

**PROGRAM (See IM735301-17E)**

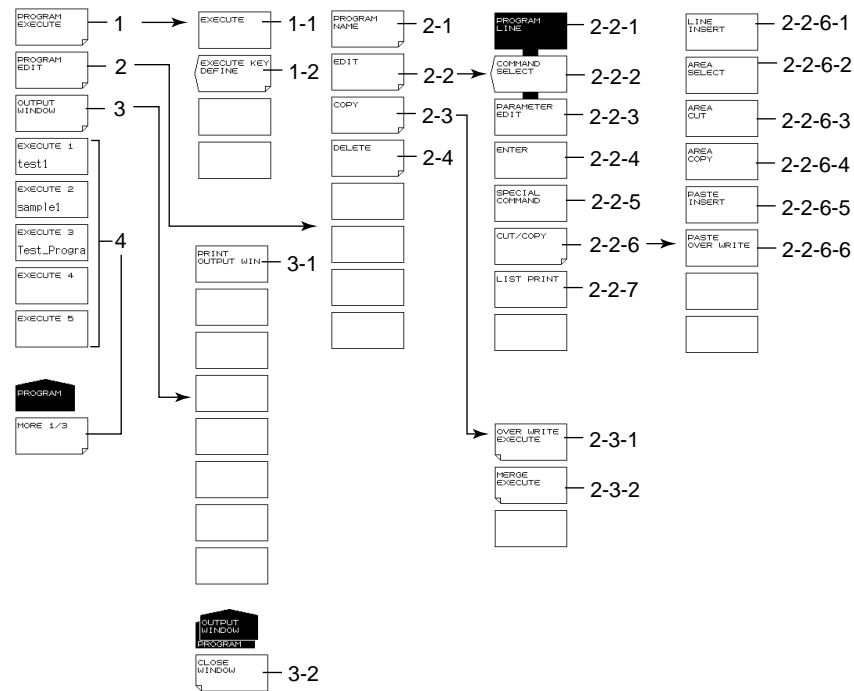

- 1 Program execution
  - 1-1 Program execution
  - 1-2 Registering programs to soft keys
- 2 Editing programs
  - 2-1 Entering program names
  - 2-2 Editing lines
    - 2-2-1 Setting program lines
    - 2-2-2 Setting function commands
    - 2-2-3 Editing parameters
    - 2-2-4 Finalizing input values
    - 2-2-5 Special command settings
    - 2-2-6 Cutting/pasting lines
      - 2-2-6-1 Inserting lines
      - 2-2-6-2 Setting the target area
      - 2-2-6-3 Deleting an area
      - 2-2-6-4 Copying an area
      - 2-2-6-5 Pasting (inserting)
      - 2-2-6-2 Pasting (overwriting)
    - 2-2-7 Printing program lists
  - 2-3 Copying programs
    - 2-3-1 Overwriting
    - 2-3-2 Copying and adding contents (merge)
  - 2-4 Deleting programs
- 3 OUTPUT WINDOW display
  - 3-1 OUTPUT WINDOW print out
  - 3-2 Closing the OUTPUT WINDOW
- 4 Executing programs registered to soft keys

## ADVANCE

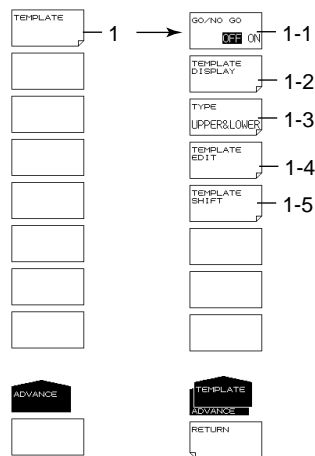

- 1 Template settings (7.12)
  - 1-1 GO/NO GO ON/OFF (7.12)
  - 1-2 Displaying templates (7.12)
  - 1-3 Setting the template type (7.12)
  - 1-4 Editing templates (7.12)
  - 1-5 Setting the template shift amount (7.12)

SYSTEM(MORE 1/4)

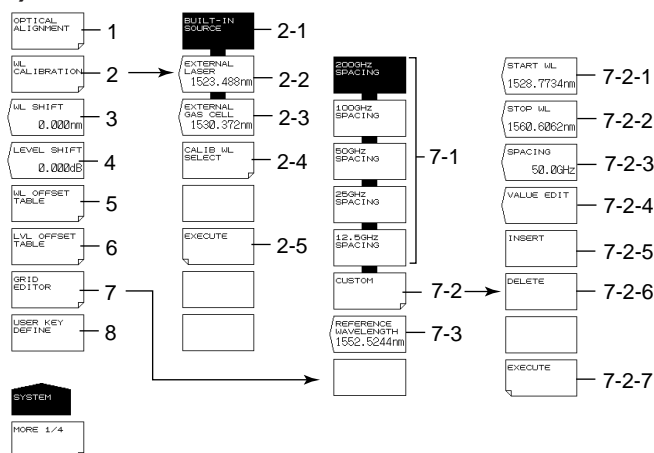

- 1 Executing monochromator alignment adjustment (3.6)
- 2 Wavelength calibration (3.7)
  - 2-1 Wavelength calibration using the internal light source (3.7)
  - 2-2 Wavelength calibration using a laser type external reference light source (3.7)
  - 2-3 Wavelength calibration using a gas cell type external reference light source (3.7)
  - 2-4 Wavelength calibration setting for wavelength calibration using an external reference light source (3.7)
  - 2-5 Executing wavelength calibration (3.7)
- 3 Setting the wavelength shift amount (value specified for the wavelength axis display value is added) (7.14)
- 4 Setting the level shift amount (value specified for the level axis display value is added) (7.14)
- 5 Editing a user wavelength calibration table (3.7)
- 6 Editing a user level calibration table (3.7)
- 7 Editing the grid table (7.10)
  - 7-1 Creating a grid table with predetermined grid spacing (7.10)
    - 7-2-1 Setting the start wavelength (7.10)
    - 7-2-2 Setting the stop wavelength (7.10)
    - 7-2-3 Setting the frequency Spacing (7.10)
    - 7-2-4 Setting channel point wavelength (7.10)
    - 7-2-5 Inserting channel points (7.10)
    - 7-2-6 Deleting channel points (7.10)
    - 7-2-7 Finalizing input values (7.10)
  - 7-2 Creating a custom grid table (an arbitrary grid table) (7.10)
    - 7-2-1 Setting the start wavelength (7.10)
    - 7-2-2 Setting the stop wavelength (7.10)
    - 7-2-3 Setting the frequency Spacing (7.10)
    - 7-2-4 Setting channel point wavelength (7.10)
    - 7-2-5 Inserting channel points (7.10)
    - 7-2-6 Deleting channel points (7.10)
    - 7-2-7 Finalizing input values (7.10)
  - 7-3 Setting the grid table reference wavelength (7.10)
- 8 Registering user keys (9.1)

SYSTEM(MORE 2/4)

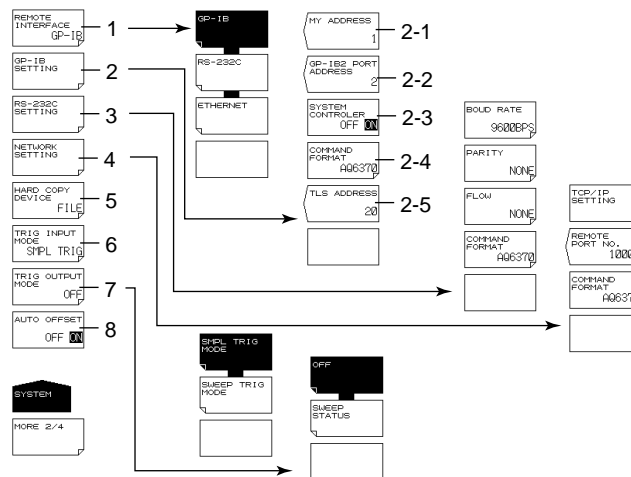

- 1 Communication interface settings (see IM 735301-17E)
- 2 GP-IB interface settings (see IM 735301-17E, 5.17)
  - 2-1 Setting the GP-IB1 port address
  - 2-2 Setting the GP-IB2 port address (5.17)
  - 2-3 System controller function ON/OFF (5.17)
  - 2-4 Command mode setting
  - 2-5 Setting the turnable laser source address for the control target (5.17)
- 3 RS-232 interface settings (see IM 735301-17E)
- 4 Ethernet interface settings (see IM 735301-17E)
- 5 Setting the screen image data output destination (9.5)
- 6 Setting the trigger input mode (5.15)
- 7 Setting the trigger output mode (5.16)
- 8 Auto offset ON/OFF (9.5)

**SYSTEM(MORE 3/4, MORE 4/4)**

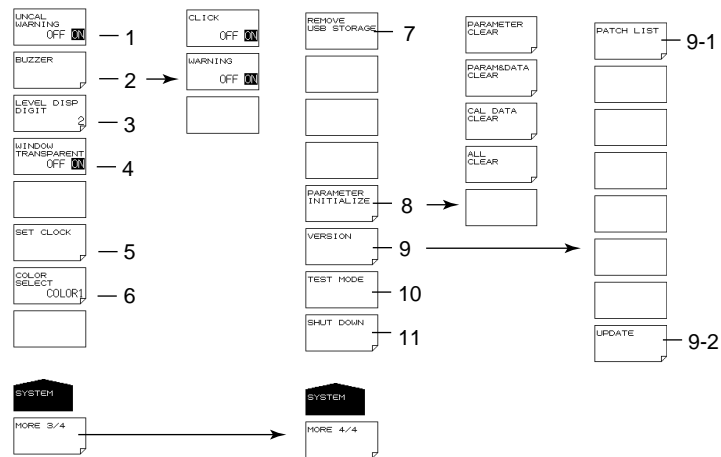

- 1 UNCAL, warning display ON/OFF (9.5)
- 2 Buzzer settings (9.5)
- 3 Setting the number of level data digits (4.4)
- 4 Semitransparent display ON/OFF (4.4)
- 5 Date/time setting (4.5)
- 6 Setting the display color (4.4)
- 7 Removing the USB storage medium (3.3, 8.1)
- 8 Initializing settings (9.2)
- 9 Displaying the software version and upgrading (10.1)
  - 9-1 Displaying the patch list (10.1)
  - 9-2 Upgrading the software (10.1)
- 10 Service menu (9.5)
- 11 System shutdown (3.4)

## Appendix 8 END USER LICENSE AGREEMENT

- You have acquired a device (“DEVICE”) that includes software licensed by YOKOGAWA ELECTRIC CORPORATION from Microsoft Licensing Inc. or its affiliates (“MS”). Those installed software products of MS origin, as well as associated media, printed materials, and “online” or electronic documentation (“SOFTWARE”) are protected by international intellectual property laws and treaties. The SOFTWARE is licensed, not sold. All rights reserved.
- IF YOU DO NOT AGREE TO THIS END USER LICENSE AGREEMENT (“EULA”), DO NOT USE THE DEVICE OR COPY THE SOFTWARE. INSTEAD, PROMPTLY CONTACT YOKOGAWA ELECTRIC CORPORATION FOR INSTRUCTIONS ON RETURN OF THE UNUSED DEVICE(S) FOR A REFUND. ANY USE OF THE SOFTWARE, INCLUDING BUT NOT LIMITED TO USE ON THE DEVICE, WILL CONSTITUTE YOUR AGREEMENT TO THIS EULA (OR RATIFICATION OF ANY PREVIOUS CONSENT).
- **GRANT OF SOFTWARE LICENSE.** This EULA grants you the following license:
  - You may use the SOFTWARE only on the DEVICE.
  - **NOT FAULT TOLERANT.** THE SOFTWARE IS NOT FAULT TOLERANT. YOKOGAWA ELECTRIC CORPORATION HAS INDEPENDENTLY DETERMINED HOW TO USE THE SOFTWARE IN THE DEVICE, AND MS HAS RELIED UPON YOKOGAWA ELECTRIC CORPORATION TO CONDUCT SUFFICIENT TESTING TO DETERMINE THAT THE SOFTWARE IS SUITABLE FOR SUCH USE.
  - **NO WARRANTIES FOR THE SOFTWARE. THE SOFTWARE is provided “AS IS” and with all faults. THE ENTIRE RISK AS TO SATISFACTORY QUALITY, PERFORMANCE, ACCURACY, AND EFFORT (INCLUDING LACK OF NEGLIGENCE) IS WITH YOU. ALSO, THERE IS NO WARRANTY AGAINST INTERFERENCE WITH YOUR ENJOYMENT OF THE SOFTWARE OR AGAINST INFRINGEMENT.** IF YOU HAVE RECEIVED ANY WARRANTIES REGARDING THE DEVICE OR THE SOFTWARE, THOSE WARRANTIES DO NOT ORIGINATE FROM, AND ARE NOT BINDING ON, MS.
  - **Note on Java Support.** The SOFTWARE may contain support for programs written in Java. Java technology is not fault tolerant and is not designed, manufactured, or intended for use or resale as online control equipment in hazardous environments requiring fail-safe performance, such as in the operation of nuclear facilities, aircraft navigation or communication systems, air traffic control, direct life support machines, or weapons systems, in which the failure of Java technology could lead directly to death, personal injury, or severe physical or environmental damage. Sun Microsystems, Inc. has contractually obligated MS to make this disclaimer.
  - **No Liability for Certain Damages. EXCEPT AS PROHIBITED BY LAW, MS SHALL HAVE NO LIABILITY FOR ANY INDIRECT, SPECIAL, CONSEQUENTIAL OR INCIDENTAL DAMAGES ARISING FROM OR IN CONNECTION WITH THE USE OR PERFORMANCE OF THE SOFTWARE. THIS LIMITATION SHALL APPLY EVEN IF ANY REMEDY FAILS OF ITS ESSENTIAL PURPOSE. IN NO EVENT SHALL MS BE LIABLE FOR ANY AMOUNT IN EXCESS OF U.S. TWO HUNDRED FIFTY DOLLARS (U.S.\$250.00).**
  - **Limitations on Reverse Engineering, Decompilation, and Disassembly.** You may not reverse engineer, decompile, or disassemble the SOFTWARE, except and only to the extent that such activity is expressly permitted by applicable law notwithstanding this limitation.
  - **SOFTWARE TRANSFER ALLOWED BUT WITH RESTRICTIONS.** You may permanently transfer rights under this EULA only as part of a permanent sale or transfer of the Device, and only if the recipient agrees to this EULA. If the SOFTWARE is an upgrade, any transfer must also include all prior versions of the SOFTWARE.
  - **EXPORT RESTRICTIONS.** You acknowledge that SOFTWARE is of US-origin. You agree to comply with all applicable international and national laws that apply to the SOFTWARE, including the U.S. Export Administration Regulations, as well as end-user, end-use and country destination restrictions issued by U.S. and other governments. For additional information on exporting the SOFTWARE, see <http://www.microsoft.com/exporting/>.

**Installation and Use.** The SOFTWARE may not be used by more than two (2) processors at any one time on the DEVICE. You may permit a maximum of ten (10) computers or other electronic devices (each a “Client”) to connect to the DEVICE to utilize the services of the SOFTWARE solely for file and print services, internet information services, and remote access (including connection sharing and telephony services). The ten (10) connection maximum includes any indirect connections made through “multiplexing” or other software or hardware which pools or aggregates connections. Except as otherwise permitted in the NetMeeting/Remote Assistance/Remote Desktop Features terms below, you may not use a Client to use, access, display or run the SOFTWARE, the SOFTWARE’s user interface or other executable software residing on the DEVICE.

If you use the DEVICE to access or utilize the services or functionality of Microsoft Windows Server products (such as Microsoft Windows NT Server 4.0 (all editions) or Microsoft Windows 2000 Server (all editions)), or use the DEVICE to permit workstation or computing devices to access or utilize the services or functionality of Microsoft Windows Server products, you may be required to obtain a Client Access License for the Device and/or each such workstation or computing device. Please refer to the end user license agreement for your Microsoft Windows Server product for additional information.

## Appendix 8 END USER LICENSE AGREEMENT

---

**Restricted Uses.** The SOFTWARE is not designed or intended for use or resale in hazardous environments requiring fail-safe performance, such as in the operation of nuclear facilities, aircraft navigation or communication systems, air traffic control, or other devices or systems in which a malfunction of the SOFTWARE would result in foreseeable risk of injury or death to the operator of the device or system, or to others.

**Restricted Functionality.** You are licensed to use the SOFTWARE to provide only the limited functionality (specific tasks or processes) for which the DEVICE has been designed and marketed by YOKOGAWA ELECTRIC CORPORATION. This license specifically prohibits any other use of the software programs or functions, or inclusion of additional software programs or functions, on the DEVICE.

**Security Updates.** Content providers are using the digital rights management technology ("Microsoft DRM") contained in this SOFTWARE to protect the integrity of their content ("Secure Content") so that their intellectual property, including copyright, in such content is not misappropriated. Owners of such Secure Content ("Secure Content Owners") may, from time to time, request MS, Microsoft Corporation or their subsidiaries to provide security related updates to the Microsoft DRM components of the SOFTWARE ("Security Updates") that may affect your ability to copy, display and/or play Secure Content through Microsoft software or third party applications that utilize Microsoft DRM. You therefore agree that, if you elect to download a license from the Internet which enables your use of Secure Content, MS, Microsoft Corporation or their subsidiaries may, in conjunction with such license, also download onto your DEVICE such Security Updates that a Secure Content Owner has requested that MS, Microsoft Corporation or their subsidiaries distribute. MS, Microsoft Corporation or their subsidiaries will not retrieve any personally identifiable information, or any other information, from your DEVICE by downloading such Security Updates.

**NetMeeting/Remote Assistance/Remote Desktop Features.** The SOFTWARE may contain NetMeeting, Remote Assistance, and Remote Desktop technologies that enable the SOFTWARE or other applications installed on the Device to be used remotely between two or more computing devices, even if the SOFTWARE or application is installed on only one Device. You may use NetMeeting, Remote Assistance, and Remote Desktop with all Microsoft products; provided however, use of these technologies with certain Microsoft products may require an additional license. For both Microsoft products and non-Microsoft products, you should consult the license agreement accompanying the applicable product or contact the applicable licensor to determine whether use of NetMeeting, Remote Assistance, or Remote Desktop is permitted without an additional license.

**Consent to Use of Data.** You agree that MS, Microsoft Corporation and their affiliates may collect and use technical information gathered in any manner as part of product support services related to the SOFTWARE. MS, Microsoft Corporation and their affiliates may use this information solely to improve their products or to provide customized services or technologies to you. MS, Microsoft Corporation and their affiliates may disclose this information to others, but not in a form that personally identifies you.

**Internet Gaming/Update Features.** If the SOFTWARE provides, and you choose to utilize, the Internet gaming or update features within the SOFTWARE, it is necessary to use certain computer system, hardware, and software information to implement the features. By using these features, you explicitly authorize MS, Microsoft Corporation and/or their designated agent to use this information solely to improve their products or to provide customized services or technologies to you. MS or Microsoft Corporation may disclose this information to others, but not in a form that personally identifies you.

**Internet-Based Services Components.** The SOFTWARE may contain components that enable and facilitate the use of certain Internet-based services. You acknowledge and agree that MS, Microsoft Corporation or their affiliates may automatically check the version of the SOFTWARE and/or its components that you are utilizing and may provide upgrades or supplements to the SOFTWARE that may be automatically downloaded to your Device.

**Links to Third Party Sites.** The SOFTWARE may provide you with the ability to link to third party sites through the use of the SOFTWARE. The third party sites are not under the control of MS, Microsoft Corporation or their affiliates. Neither MS nor Microsoft Corporation nor their affiliates are responsible for (i) the contents of any third party sites, any links contained in third party sites, or any changes or updates to third party sites, or (ii) webcasting or any other form of transmission received from any third party sites. If the SOFTWARE provides links to third party sites, those links are provided to you only as a convenience, and the inclusion of any link does not imply an endorsement of the third party site by MS, Microsoft Corporation or their affiliates.

**Additional Software/Services.** The SOFTWARE may permit YOKOGAWA ELECTRIC CORPORATION, MS, Microsoft Corporation or their affiliates to provide or make available to you SOFTWARE updates, supplements, add-on components, or Internet-based services components of the SOFTWARE after the date you obtain your initial copy of the SOFTWARE ("Supplemental Components").

If YOKOGAWA ELECTRIC CORPORATION provides or makes available to you Supplemental Components and no other EULA terms are provided along with the Supplemental Components, then the terms of this EULA shall apply.

If MS, Microsoft Corporation or their affiliates make available Supplemental Components, and no other EULA terms are provided, then the terms of this EULA shall apply, except that the MS, Microsoft Corporation or affiliate entity providing the Supplemental Component(s) shall be the licensor of the Supplemental Component(s).

YOKOGAWA ELECTRIC CORPORATION, MS, Microsoft Corporation and their affiliates reserve the right to discontinue any Internet-based services provided to you or made available to you through the use of the SOFTWARE.

This EULA does not grant you any rights to use the Windows Media Format Software Development Kit ("WMFSDK") components contained in the SOFTWARE to develop a software application that uses Windows Media technology. If you wish to use the WMFSDK to develop such an application, visit <http://msdn.microsoft.com/workshop/imedia/windowsmedia/sdk/wmsdk.asp>, accept a separate license for the WMFSDK, download the appropriate WMFSDK, and install it on your system.

# Index

## Symbols

µm/ENTER Key .....	1-5
0nm SWEEP TIME .....	7-41

## A

Absolute Level Accuracy .....	3-21, 7-59
ABSOLUTE Templates .....	7-51
Active Trace .....	5-33
ADVANCE .....	1-4, App-63
Air Wavelength .....	2-3, 5-2
Algorithm for determining the ASE level .....	7-24
Algorithms for Spectrum Width Analysis .....	7-3
Algorithms for WDM channel detection .....	7-32
Alignment .....	2-2, 3-10
ALL MARKER CLEAR .....	6-45
Analog Out .....	2-6, 5-47
ANALYSIS .....	1-3, App-57
Analysis between Line Markers .....	2-12, 7-54
Analysis in the Zoom Area .....	2-12, 7-55
Arrow keys .....	1-5, 4-5
ASE ALGO .....	7-24
ASE Level Measurement .....	7-24
Automatic Analysis on Each Sweep .....	7-2
Automatic Offset .....	9-18
Auto Measurement .....	2-2, 5-1
Auto Search .....	6-45
AUTO SEARCH ON/OFF .....	6-45
AUTO SUB SCALE .....	5-10
AVERAGE TIMES .....	5-31
Averaging Times (Roll) .....	6-11

## B

BACK SPACE Key .....	1-5
BIN .....	8-17
BOTTOM SEARCH .....	6-44
Buzzer Settings .....	9-17

## C

CALCULATE Mode .....	2-8
Calculation Range .....	6-24
Calibration .....	2-2, 3-10
Calibration Table .....	3-19
CENTER .....	1-3, App-49
Center Frequency .....	5-19
Center Wavelength .....	5-18
CHOP .....	5-30
CHOP MODE .....	5-30
Clearing Traces .....	6-41
CLEAR MARKER .....	6-44
COARSE Key .....	1-5
Colors .....	4-7
Connector Adapter .....	3-4
COPY .....	1-4
Copying Traces .....	6-40
CSV .....	8-17, 8-33
CSV Data Format .....	8-18
Curve Fit .....	2-8
Curve Fit Target Range .....	6-22
Curve Fit Target Trace .....	6-22
Curve Fitting Algorithm .....	6-24
Custom Grid Table .....	7-38, App-1

## D

DATA ENTRY Section .....	1-5
Data Initialization .....	2-13
Date .....	4-8
DELAY .....	5-41
DFB-LD .....	2-11
DFB-LD Analysis Function .....	App-15
DISPLAY .....	1-3, App-52
DISPLAY MASK .....	7-15
DISPLAY TYPE .....	7-17
DT6 .....	8-32
DUAL TRACE .....	7-16
DUT .....	3-12

## E

EDFA-NF Analysis Parameters .....	7-23
EDGE .....	5-41
ENTER Key .....	1-5
ENVELOPE Method .....	App-4
External Trigger .....	2-5
External Trigger Mode .....	5-40
Extrapolating Template Data .....	7-52
EXT TRIGGER MODE .....	5-38

## F

FEED .....	1-4
FILE .....	1-4, App-59
FITTING ALGO .....	7-16, 7-24
FITTING AREA .....	7-24
FIX @ .....	5-33
Fixed Markers .....	6-25, 6-33
Fixing a Waveform .....	6-8
FIX Mode .....	2-7, 5-33
FP-LD .....	2-11
FP-LD Analysis Function .....	App-16
Frequency .....	2-3
Frequency Display Mode .....	5-5
Frequency Display Sweep Width .....	6-7
FUNCTION Section .....	1-3
Fuses .....	10-7

## G

Gas Cell .....	3-17
Go/No Go Judgment .....	2-12, 7-48
Grid Table .....	7-38, App-1

## H

HELP .....	1-4, 2-13, 9-15
HOLD .....	6-37
Horizontal Axis .....	5-2
HRZN .....	6-39

## I

Initialization .....	9-2
initial values .....	9-3
Installation .....	3-1
Interval .....	5-28

## K

Keyboard .....	3-6, 4-4
----------------	----------

## Index

### L

Laser	3-17
LED	2-11
LED Analysis Function	App-17
LEVEL	1-3, App-50
Level Accuracy	3-14, 3-21
Level Fluctuations in Single-Wavelength Light	2-12
Level Line Markers	6-35
LEVEL SHIFT	7-59
Limitations on Wavelength Resolution	3-20
LIN BASE LEVEL	5-6
Linear Scale	5-3, 5-14
Line Markers	2-9, 6-30, 6-35
Line Markers in the Overview Window	6-35
LIN MATH	6-14, 6-16, 6-17
LOCAL	1-4
LOG MATH	6-14, 6-16, 6-17
Log Scale	5-3, 5-14
LOG SCALE** *dB/D	5-5
Lower Limit Line Judgment	7-48
Lower Trace	6-36

### M

MARKER	1-3, App-55
Marker Data in the Data Area	6-33
MARKER DISPLAY	6-34
Markers	2-9, 6-33
MASK AREA	7-16, 7-25
MAX HOLD	2-8, 6-10
Measurement Sensitivity	5-5
MEMORY	1-4, App-58
Memory List	8-4
MIN HOLD	2-8, 6-10
MODE DIFF	6-45, 7-15, 7-23, 7-34
Monochromator	5-30
Mouse	3-5, 4-3
Moving Markers	6-25, 6-33

### N

NEXT LEVEL SEARCH	6-44
NEXT SEARCH LEFT	6-44
NEXT SEARCH RIGHT	6-44
nm/ENTER Key	1-5
NOISE ALGO	7-15
NOISE AREA	7-16
NOISE BW	7-16
Noise Mask	2-10, 6-38
NORMALIZE	6-17
Normalized Display Function	2-8
Notch Width	2-11
Notch Width Measurement	7-4, App-9
Number of Vertical Axis Divisions	5-4
Numerical Aperture (NA)	7-58
Numeric keypad	1-5, 4-5

### O

OFFSET(IN)	7-24
OFFSET(OUT)	7-24
One-Action Keys	2-3, 5-14, 5-18, 5-23
Optical Amp Analysis	2-11
Optical Connectors	3-4
Optical Fibers	3-14
Optical Filter Characteristics	2-12
OUTPUT SLOPE	7-18
Overview	2-7
Overview Window	6-4

### P

Panel Keys	1-3
Peak Curve Fit	2-8
Peak Curve Fit Target Range	6-23
Peak Curve Fit Target Trace	6-23
PEAK HOLD	5-38
PEAK RMS Method	App-8
PEAK SEARCH	1-3, 6-44, App-56
PLS LIGHT MEASURE	5-38
PMD	2-11
PMD Analysis Function	App-14
POINT DISPLAY	7-18, 7-25
POWER Analysis Function	App-13
Power Density	2-4
Printing Out Analysis Results	7-2
Printing Out Marker Values	6-29
PROGRAM	1-4, 2-13, App-62
Pulse Light Measurement	5-37
Pulse Width	5-38

### R

REF LEVEL	5-11
Registering Soft Keys	2-13
RELATIVE Templates	7-51
Remote	2-13
Repeat Sweep	2-2
Replacement Parts	10-11
Resolution	3-14, 5-24
Resolutions of 0.020 nm	3-23, 5-26
Results Display	7-3
Ripples	5-26
Ripples in the 1350–1450 nm Area	3-23
RMS Method	App-7
ROLL AVG	6-12
ROLL AVG Mode	2-8
Roll Paper	4-9
Rotary knob	1-5, 4-5

### S

Sampling points	5-28
Saving Analysis Results	7-2
Screen Image Data Output Destination	9-18
SEARCH/ANA L1-L2 OFF/ON	6-45
SEARCH/ANA ZOOM AREA OFF/ON	6-45
Second-Order Diffracted Light	3-23
SEGMENT MEASURE	5-35
Segment Measurement	2-2
SEGMENT POINT	5-35
Sensitivity	5-38
Sensitivity and Vertical Axis Effective Range	3-22
SET MARKER	6-44
SETUP	1-3, App-51
Single Sweep	2-2
SMPL TRIG	5-41
SMSR	2-11, 7-7
SMSR Analysis Function	App-11
Soft Keys	4-1
SPAN	1-3, App-49
Spectrum Width	2-11
SPEC WIDTH THRESH	7-3
Split Display	2-9
Split Screen	6-36
Standard Grid Table	7-38, App-1
Start Frequency	5-19, 5-23
Start Wavelength	5-18, 5-23
Stop Frequency	5-19, 5-23
Stop Wavelength	5-18, 5-23

Stray Light .....	5-30
Strings .....	4-6
Sub Scale .....	5-7
Sub Scale REF Position .....	5-7
SWEEP.....	1-3, App-49
Sweep Average .....	6-11
Sweeping between Line Markers .....	5-36
SWEEP INTERVAL .....	5-35
SWEEP TRIG .....	5-41
Sweep Trigger .....	2-5
Sweep Width .....	5-23
Switching between Wavelength and Frequency.....	2-3
Synchronous Sweep.....	2-2
SYSTEM.....	1-4, App-64

**T**

Target Line.....	7-49
Template.....	2-12
Template Data .....	7-50
Template Data Format .....	7-53
Template Data Types.....	7-51
TEST BAND .....	7-34
Test Mode .....	9-17
THRESH LEVEL.....	7-15, 7-23, 7-34
THRESH Method.....	App-2
Time.....	4-8
TRACE .....	1-3, 2-7, App-53
Trace-to-Trace Calculations .....	6-14
Trace List.....	6-41
Transparent .....	4-7
Trigger Input Mode .....	5-39
Trigger Output .....	5-42
Tunable Laser Source .....	5-43

**U**

UNCAL .....	5-24, 5-26, 9-17
UNDO.....	1-4
Units for the Vertical Axis.....	5-4
Updating a Waveform .....	6-8
Upgrade.....	10-1
Upgrading the Firmware.....	10-1
Upper Limit Line Judgment.....	7-48
Upper Trace.....	6-36
USB Mouse .....	2-13
USB Storage Devices.....	3-7
USB Storage Media.....	8-1
USER.....	1-4

**V**

Vacuum Wavelength.....	2-3, 5-2
VERT .....	6-39
Vertical Axis .....	5-3
Vertical Axis Effective Range.....	5-5
VIEW @.....	5-33

**W**

Warning .....	9-17, 10-12
Wavelength.....	2-3
Wavelength Display Mode.....	5-5
Wavelength Display Sweep Width.....	6-6
Wavelength Line Markers.....	6-35
WDM Analysis .....	2-11
WDM analysis function parameters.....	7-14
WDM Filter Analysis Parameters.....	7-32
WL SHIFT .....	7-59
WRITE @ .....	5-33
WRITE Mode.....	2-7, 5-33

**Z**

ZOOM.....	1-3, 2-7, App-52
Zoom Center Frequency.....	6-7
Zoom Center Wavelength.....	6-6
Zooming In/Out.....	6-1, 6-3
Zoom Start Frequency.....	6-7
Zoom Start Wavelength.....	6-6
Zoom Stop Frequency .....	6-7
Zoom Stop Wavelength .....	6-6